

**SPECIFICATION  
FOR  
LCD Module  
YXM024TS-1**

<b>MODULE:</b>	<b>YXM024TS-1</b>
<b>CUSTOMER:</b>	

<b>REV</b>	<b>DESCRIPTION</b>	<b>DATE</b>
<b>1</b>	<b>FIRST ISSUE</b>	<b>2011.4. 6</b>

<b>TZD</b>	<b>INITIAL</b>	<b>DATE</b>
<b>PREPARED BY</b>		<b>2010.4.6</b>
<b>CHECKED BY</b>		
<b>APPROVED BY</b>		

<b>CUSTOMER</b>	<b>INITIAL</b>	<b>DATE</b>
<b>APPROVED BY</b>		



### Revision History

Data	Rev. No.	Page	Summary
2011.4. 6	1		FIRST ISSUE

## Contents

### General Description

1. Optical Characteristics
2. Electrical Characteristics
3. Block Diagram
4. Outline dimension
5. Input Terminal Pin Assignment
6. Operating Principle & Methods
7. Display ON/OFF Sequence
8. Reliability Test Result
9. Packing
10. Cautions and Handling Precautions
11. LCD Module Out-Going Quality Level
12. BHL&BMDT Customer Quality Service Process
13. LCD Module Operation Instruction

Part. No	YXM024TS-1	REV	1.0	Page 3 of 23
----------	------------	-----	-----	--------------

# SHENZHEN SUNFLY TECHNOLOGY CO., LTD.

## General Description

### \* Description

YXM024TS-1 is a color active matrix TFT (Thin Film Transistor) LCD (liquid crystal display) that uses amorphous silicon TFT as a switching device. This model is composed of a Transmissive type TFT-LCD Panel, driver circuit, back-light unit. The resolution of a 2.4" TFT-LCD contains 240 x 320 pixels, and can display up to 262K colors.

### \* Features

-Low Input Voltage: VCC: 2.5~3.3V; IOVCC: 1.65~3.3V

-Display Colors of TFT LCD: 262K colors

-CPU Interface: 8080 parallel 8/9/16/18 bit

-Internal Power Supply Circuit.

General Information Items	Specification	Unit	Note
	Main Panel		
Display area(AA)	36.72(H) *48.96(V) (2.4 inch )	mm	-
Driver element	a-Si TFT active matrix	-	-
Display colors	262K	colors	-
Number of pixels	240(RGB) *320	dots	-
Pixel arrangement	RGB vertical stripe	-	-
Pixel pitch	0.153(H) *0.153(V)	mm	-
Viewing angle	12	o'clock	-
Drive IC	HX8347G	-	-
Display mode	Transmissive/ Normally White	-	-
Operating temperature	-20~+70	°C	-
Storage temperature	-30~+80	°C	-

### \* Mechanical Information

Item		Min.	Typ.	Max.	Unit	Note
Module size	Horizontal(H)	-	42.32	-	mm	-
	Vertical(V)	-	60.92	-	mm	-
	Depth(D)	-	2.25	-	mm	-
Weight		-	TBD	-	g	-

## 1. Optical Characteristics

The test of Optical specifications shall be measured in a dark room (ambient luminance  $\leq 1$  lux and temperature =  $25 \pm 2^\circ\text{C}$ ) with the equipment of Luminance meter system (Goniometer system and TOPCON BM-5) and test unit shall be located at an approximate distance 50cm from the LCD surface at a viewing angle of  $\theta$  and  $\phi$  equal to  $0^\circ$ . We refer to  $\theta=0$  ( $=\theta_3$ ) as the 3 o'clock direction (the "right"),  $\theta=90$  ( $=\theta_{12}$ ) as the 12 o'clock direction ("upward"),  $\theta=180$  ( $=\theta_9$ ) as the 9 o'clock direction ("left") and  $\theta=270$  ( $=\theta_6$ ) as the 6 o'clock direction ("bottom"). While scanning  $\theta$  and/or  $\phi$ , the center of the measuring spot on the Display surface shall stay fixed. Optimum viewing angle direction is 6 o'clock.

Parameter		Symbol	Condition	Min.	Typ.	Max.	Unit	Remark
Viewing Angle range	Horizontal	$\theta_3$	CR > 10		45	-	Deg.	Normal Pol Note 1
		$\theta_9$			45	-	Deg.	
	Vertical	$\theta_{12}$			20	-	Deg.	
		$\theta_6$			50	-	Deg.	
Luminance Contrast ratio		CR	$\theta = 0^\circ$	350	500			Note 2
Transmittance		T(%)	$\theta = 0^\circ$		5.1	-	%	Base on C light Note 3
White Chromaticity		$x_w$ $y_w$	$\theta = 0^\circ$					Note 4 CF Glass
Reproduction of color	Red	$x_R$	$\theta = 0^\circ$	0.669	0.654	0.639		
		$y_R$		0.330	0.315	0.300		
	Green	$x_G$		0.302	0.287	0.272		
		$y_G$		0.559	0.544	0.529		
	Blue	$x_B$		0.153	0.138	0.123		
		$y_B$		0.136	0.121	0.106		
Threshold Voltage		Vsat Vth			2.5 1.45		V V	Figure 3
Response Time (Rising + Falling)		$T_{RT}$	Ta= $25^\circ\text{C}$ $\theta = 0^\circ$	-	25		ms	Note 5

Notes : 1. Viewing angle is the angle at which the contrast ratio is greater than 10. The viewing angles are determined for the horizontal or 3, 9 o'clock direction and the vertical or 6, 12 o'clock direction with respect to the optical axis which is normal to the LCD surface (see Figure 4 shown in Appendix).

2. Contrast measurements shall be made at viewing angle of  $\theta=0$  and at the center of the LCD surface. Luminance shall be measured with all pixels in the view field set first to white, then to the dark (black) state.

(see Figure 4) Luminance Contrast Ratio (CR) is defined mathematically.

$$CR = \frac{\text{Luminance when displaying a white raster}}{\text{Luminance when displaying a black raster}}$$

3. Transmittance is the Value with Polarizer
4. The color chromaticity coordinates specified in Table 4 shall be calculated from the spectral data measured with all pixels first in red, green, blue and white. Measurements shall be made at the center of the panel. Measurement condition is C- light Source & Halogen Lampe
5. The electro-optical response time measurements shall be made as Figure 5 by switching the "data" input signal ON and OFF. The times needed for the transmittance to change from 10% to 90% is  $T_r$ , and 90% to 10% is  $T_d$ .

Figure 3. The Definition of  $V_{th}$  &  $V_{sat}$

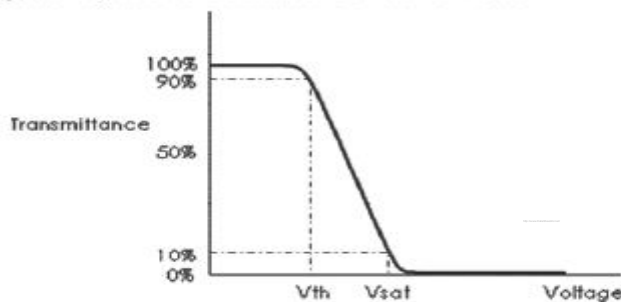

Figure 4. Measurement Set Up

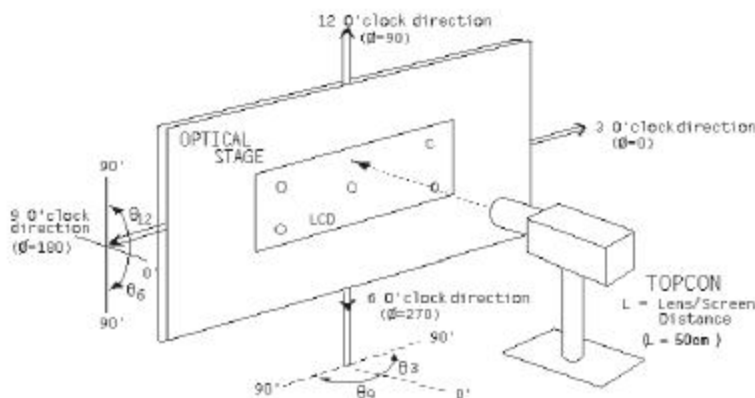
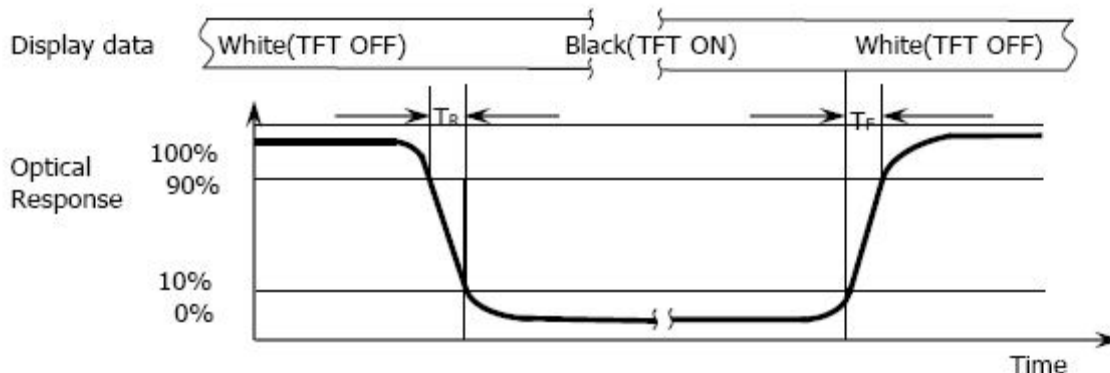

Figure 5. Response Time Testing



## 2. Electrical Characteristics

### 2.1 Absolute Maximum Rating ( $T_a=25$ VSS=0V)

Characteristics	Symbol	Min.	Typ.	Max.	Unit	Note
System voltage	VCC	-0.3	2.8	+4.6	V	-
Supply voltage (Digital)	IOVCC	-0.3	-	+4.6	V	-
Supply voltage (Logic)	IOVCC	-0.3	-	+4.6	V	-
Operating temperature	$T_{OP}$	-20	-	+70	°C	1,
Storage temperature	$T_{ST}$	-30	-	+80	°C	2

Note1: Background color changes slightly depending on ambient temperature. This phenomenon is reversible.  $T_a 70^{\circ}\text{C}$ : 75%RH max

$T_a > 70^{\circ}\text{C}$ : absolute humidity must be lower than the humidity of 75%RH at  $70^{\circ}\text{C}$

Note2:  $T_a$  at  $-30^{\circ}\text{C}$  will be <48hrs, at  $80^{\circ}\text{C}$  will be <120hrs

# SHENZHEN SUNFLY TECHNOLOGY CO., LTD.

## 2.2 DC Electrical Characteristics

Characteristics	Symbol	Min.	Typ.	Max.	Unit	Note
System voltage	VCC	2.5	2.8	3.3	V	-
Digital & Logic operation Supply voltage	IOVCC	1.65	1.8	3.3	V	-
Normal mode Current consumption	VCC <sub>I</sub>	-	8	-	mA	-
Sleep-in mode Current consumption	VCC <sub>I</sub>	-	100	-	uA	-
Level input voltage	V <sub>IH</sub>	0.8 IOVCC	-	IOVCC	V	-
	V <sub>IL</sub>	GND	-	0.2 IOVCC	V	-
Level output voltage	V <sub>OH</sub>	0.8 IOVCC	-	IOVCC	V	-
	V <sub>OL</sub>	GND	-	0.2 IOVCC	V	-



# SHENZHEN SUNFLY TECHNOLOGY CO., LTD.

---

## 2.3 LED Backlight Characteristics

The back-light system is edge-lighting type with 4chips White Serial

Item	Symbol	Min.	Typ.	Max.	Unit	Note
Forward Current	$I_F$	-	15	-	mA	-
Forward Voltage	$V_F$	-	12.8	-	V	-
LCM Luminance	$L_V$	200		-	cd/m <sup>2</sup>	$I_B=15mA$
Uniformity	AVg	80	-	-	%	-

**3. Block Diagram**

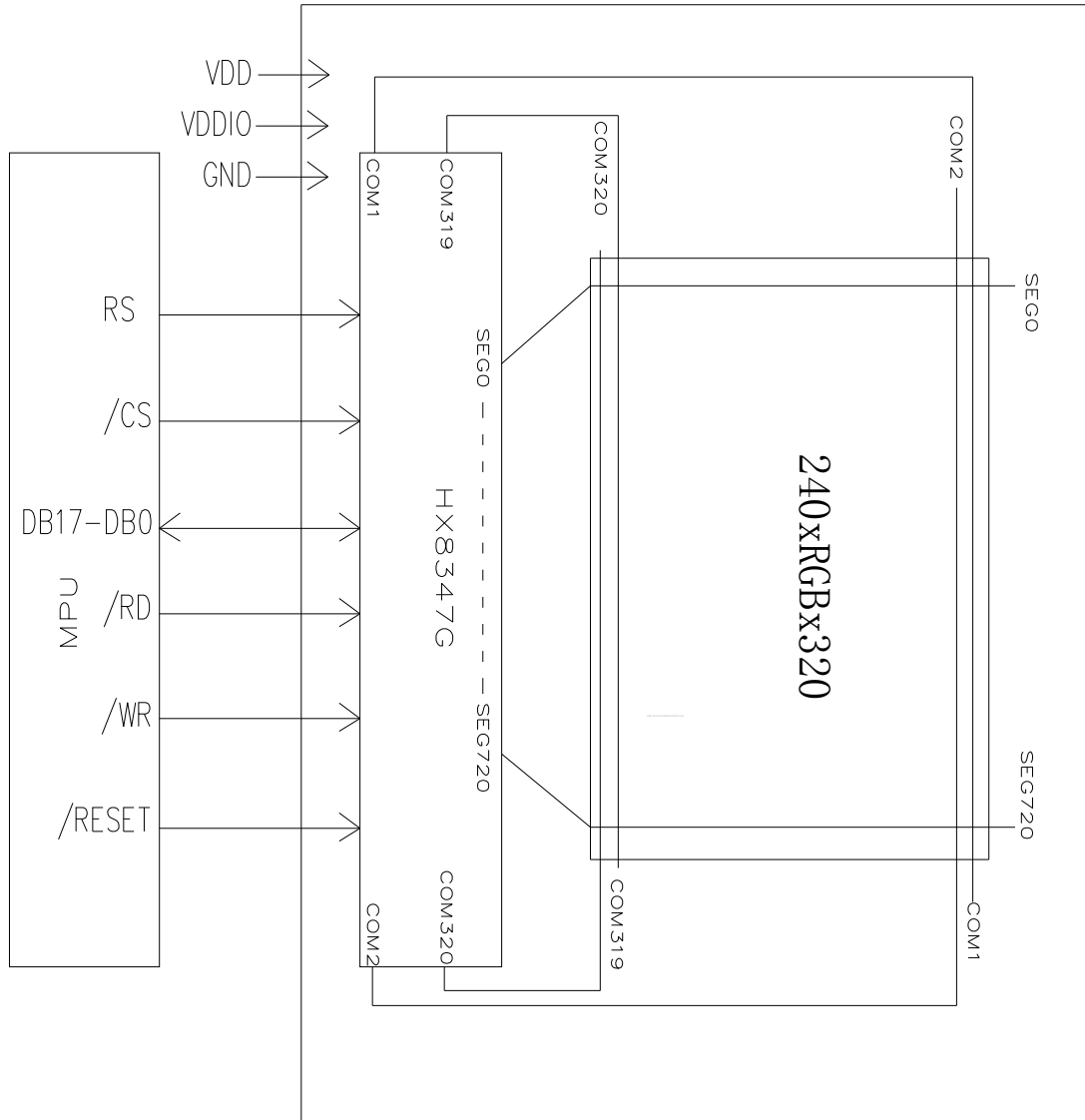



## 5. Input terminal Pin Assignment

Pin NO.	Symbol	Level	Function
1	LEDA	H	Backlight+
2	LEDK	L	Backlight-
3	GND	L	Ground
	GND	L	Ground
4	IM0	H/L	System interface select
6	IM1	H/L	System interface select.
7	IM2	H/L	System interface select.
8	IM3	H/L	System interface select.
9	RESET	H/L	Hardware reset pin
10	CS	H/L	Chip select input pin
11	RS	H/L	A register select signal
12	WR	H/L	Write enable clock input pin
13	RD	H/L	Read enable clock input pin
14	DB0	H/L	DATA BUS DB0
15	DB9	H/L	DATA BUS DB9
16-23	DB1-DB8	H/L	DATA BUS DB1-DB8
24-31	DB10-DB17	H/L	DATA BUS DB10-DB17
32	NC		No connection
33	VSYNC	H/L	Vertical synchronizing signal in RGB interface.
34	HSYNC	H/L	Horizontal synchronizing signal in RGB interface.
35	DOTCLK	H/L	Data enable signal in RGB interface.
36	GND	L	Ground
37	ENABLE	H/L	A data ENABLE signal in RGB I/F mode.
38	SDI	H/L	Serial data input pin and output pin(SDA) in serial bus
39	NC		No connection
40-41	VCI	H	Power supply(2.5-3.3V)
42-43	IOVCC	H	Power supply(1.65-3.3V)
44-45	GND	L	Ground

# SHENZHEN SUNFLY TECHNOLOGY CO., LTD.

IM3	IM2	IM1	IM0	Interface mode
0	0	0	0	8080 MCU 16-bits Parallel type I
0	0	0	1	8080 MCU 8-bits Parallel type I
0	0	1	0	8080 MCU 16-bits Parallel type II
0	0	1	1	8080 MCU 8-bits Paralle type II
<b>1</b>	<b>0</b>	<b>0</b>	<b>0</b>	<b>8080 MCU 18-bits Parallel type I</b>
1	0	0	1	8080 MCU 9-bits Parallel type I
1	0	1	0	8080 MCU 18-bits Parallel type II
1	0	1	1	8080 MCU 9-bits Parallel type II

## 6. Operating Principle & Methods

Please refer to HX8347G datasheet for more details.

### Timing Characteristics

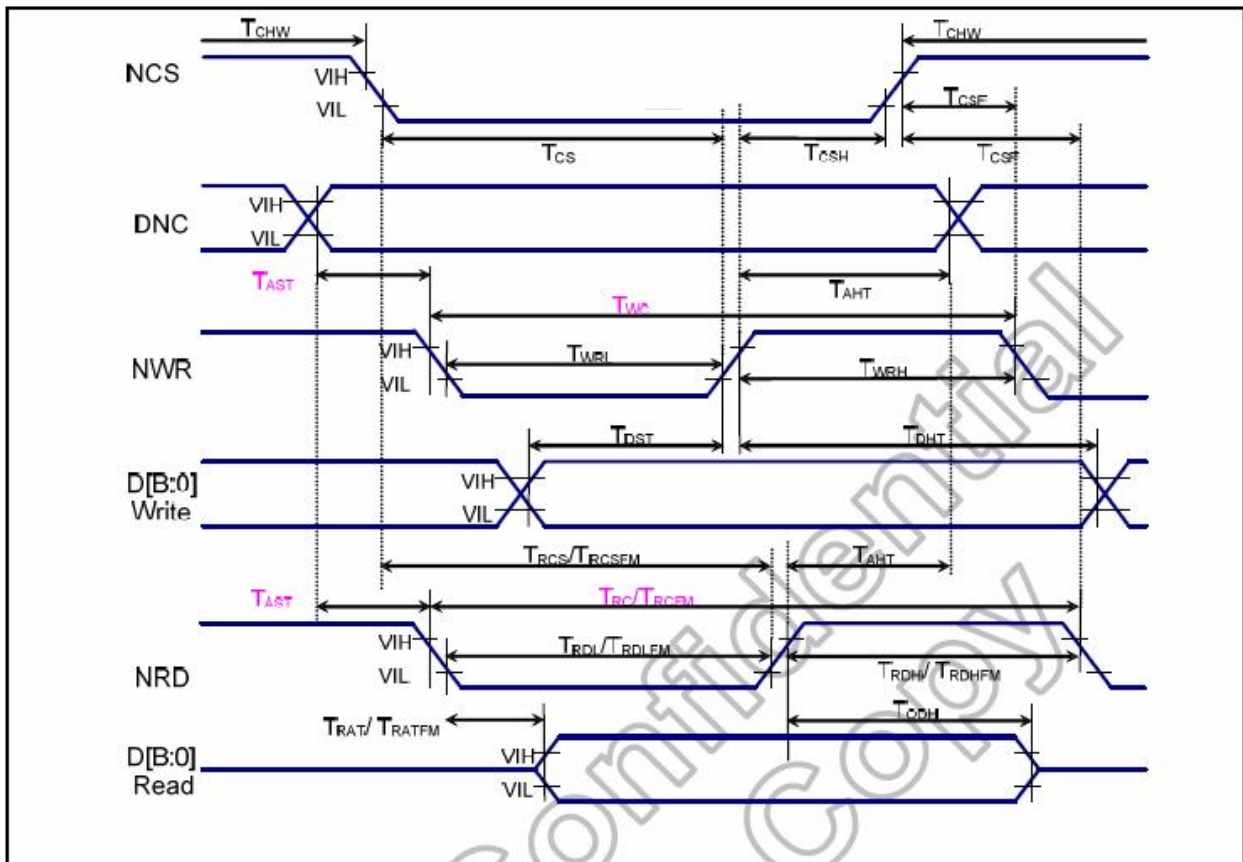

# SHENZHEN SUNFLY TECHNOLOGY CO., LTD.

(VSSA=0V, IOVCC=1.65V to 3.3V, VCI=2.3V to 3.3V, T<sub>A</sub> = -30 to 70° C)

Signal	Symbol	Parameter	Spec.			Unit	Description
			Min.	Typ.	Max.		
DNC_SCL	tAST	Address setup time	10	-	-	ns	-
	tAHT	Address hold time (Write/Read)	10	-	-		
NCS	tCHW	Chip select "H" pulse width	0	-	-	ns	-
	tCS	Chip select setup time (Write)	15	-	-		
	tRCS	Chip select setup time (Read ID)	45	-	-		
	tRCSFM	Chip select setup time (Read FM)	355	-	-		
	tCSF	Chip select wait time (Write/Read)	10	-	-		
	tCSH	Chip select hold time	10	-	-		
NWR_SCL	tWC	Write cycle( 1pixel for one write)	100	-	-	ns	-
	tWC	Write cycle (1 pixel for 2 or 3 write)	50	-	-		
	tWRH	Control pulse "H" duration	15	-	-		
	tWRL	Control pulse "L" duration	15	-	-		
NRD(ID)	tRC	Read cycle (ID)	160	-	-	ns	When read ID data
	tRDH	Control pulse "H" duration (ID)	90	-	-		
	tRDH	Control pulse "L" duration (ID)	45	-	-		
NRD(FM)	tRCFM	Read cycle (FM) ( 1pixel for one read)	600	-	-	ns	When read from frame memory
	tRCFM	Read cycle (FM) (1 pixel for 2 or 3 read)	400	-	-		
	tRDHFM	Control pulse "H" duration (FM)	90	-	-		
	tRDHFM	Control pulse "L" duration (FM)	355	-	-		
DB17 to DB0	tDST	Data setup time	10	-	-	ns	For maximum CL=30pF For minimum CL=8pF
	tDHT	Data hold time	10	-	-		
	tRAT	Read access time (ID)	-	-	100		
	tRATFM	Read access time (FM)	-	-	340		
	tODH	Output disable time	20	-	80		

**Note:** The input signal rise time and fall time (tr, tf) is specified at 15 ns or less.  
Logic high and low levels are specified as 30% and 70% of IOVCC for Input signals.

## 7. Display ON/OFF Sequence

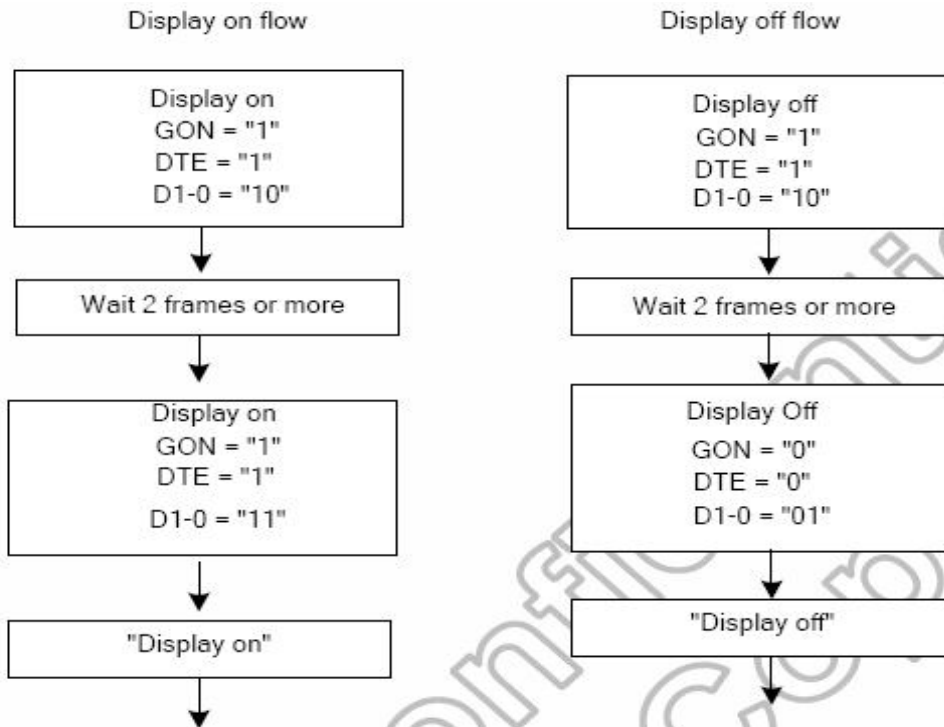

Figure 5.37: Display on/off set flow

# SHENZHEN SUNFLY TECHNOLOGY CO., LTD.

## 8. Reliability Test Result

### 8.1 Condition

Item	Condition	Sample Size	Test Result	Note
Low Temperature Operating Life test	-20℃, 96HR	3ea	pass	-
Thermal Humidity Operating Life test	40℃, 90%RH, 96HR	3ea	pass	-
Temperature Cycle ON/OFF test	-20℃ ↔ 70℃, ON/OFF, 20CYC	3ea	pass	(1)
High Temperature Storage test	80℃, 96HR	3ea	pass	-
Low Temperature Storage test	- 30℃, 96HR	3ea	pass	-
Thermal Shock Resistance	The sample should be allowed to stand the following 5 cycles of operation: TSTL for 30 minutes -> normal temperature for 5 minutes -> TSTH for 30 minutes -> normal temperature for 5 minutes, as one cycle, then taking it out and drying it at normal temperature, and allowing it stand for 24 hours	3ea	pass	
Box Drop Test	1 Corner 3 Edges 6 faces, 66cm(MEDIUM BOX)	1box	pass	-

Note (1) ON Time over 10 seconds, OFF Time under 10 seconds

## 9. Packing

TBD

## 10. Cautions and Handling Precautions

### 10.1 Handling and Operating the Module

- (1) When the module is assembled, it should be attached to the system firmly. Do not warp or twist the module during assembly work.
- (2) Protect the module from physical shock or any force. In addition to damage, this may cause improper operation or damage to the module and back-light unit.
- (3) Note that polarizer is very fragile and could be easily damaged. Do not press or scratch the surface.
- (4) Do not allow drops of water or chemicals to remain on the display surface. If you have the droplets for a long time, staining and discoloration may occur.
- (5) If the surface of the polarizer is dirty, clean it using some absorbent cotton or soft cloth.
- (6) The desirable cleaners are water, IPA (Isopropyl Alcohol) or Hexane. Do not use ketone type materials (ex. Acetone), Ethyl alcohol, Toluene, Ethyl acid or Methyl chloride. It might permanent damage to the polarizer due to chemical reaction.
- (7) If the liquid crystal material leaks from the panel, it should be kept away from the eyes or mouth. In case of contact with hands, legs, or clothes, it must be washed away thoroughly with soap.
- (8) Protect the module from static; it may cause damage to the CMOS ICs.
- (9) Use finger-stalls with soft gloves in order to keep display clean during the incoming inspection and assembly process.
- (10) Do not disassemble the module.
- (11) Protection film for polarizer on the module shall be slowly peeled off just before use so that the electrostatic charge can be minimized.
- (12) Pins of I/F connector shall not be touched directly with bare hands.
- (13) Do not connect, disconnect the module in the "Power ON" condition.
- (14) Power supply should always be turned on/off by the item 6.1 Power On Sequence & 6.2 Power Off Sequence

### 10.2 Storage and Transportation.

- (1) Do not leave the panel in high temperature, and high humidity for a long time.  
It is highly recommended to store the module with temperature from 0 to 35 °C and relative humidity of less than 70%
- (2) Do not store the TFT-LCD module in direct sunlight.
- (3) The module shall be stored in a dark place. When storing the modules for a long time, be sure to adopt effective measures for protecting the modules from strong ultraviolet radiation, sunlight, or fluorescent light.
- (4) It is recommended that the modules should be stored under a condition where no condensation is allowed. Formation of dewdrops may cause an abnormal operation or a failure of the module. In particular, the greatest possible care should be taken to prevent any module from being operated where condensation

Part. No	YXM024TS-1	REV	1.0	Page 16 of 23
----------	------------	-----	-----	---------------



has occurred inside.

(5) This panel has its circuitry FPC on the bottom side and should be handled carefully in order not to be stressed.

## 11. LCD Module Out-Going Quality Level

### 11. LCD Module Out-Going Quality Level

**(1.0) Purpose**

The LCD specification provides outgoing provision and its expected quality level based on our outgoing inspection of LCD.

**(2.0) Applicable Scope**

The LCD specification is applicable to the arrangement in regard to outgoing inspection and quality assurance after it.

**(3.0) Quality Specification**

**(3.1) Quality Level**

The quality level of BHL&BMDT are based on GB/T2828.1, Apply Level II, normal inspection by single sampling.

Rank	Item	AQL	Note
Major(MA)	Segment Short	0.65	
	Segment Missing		
	Solder Bridging		
	Outside Dimension		
	Cold Solder		
Minor (MI)	Black Spots, Foreign Substance, White Spots, Pinhole, Segment Deformation Air Bubbles between Glass & Polarizer, Scratches(Glass & Polarizer), Color Variation, Solder Ball, Misalignment	1.0	

Note) AQL- Acceptable Quality Level

**(3.2) Appearance Standards**

**1) Inspection Conditions**

The LCD shall be inspected under 20W white fluorescent lamp light.

The distance between the eyes and the sample shall be 30cm.

All directions for inspecting the sample should be within 30° to perpendicular line.

**2) Definition of the Area**

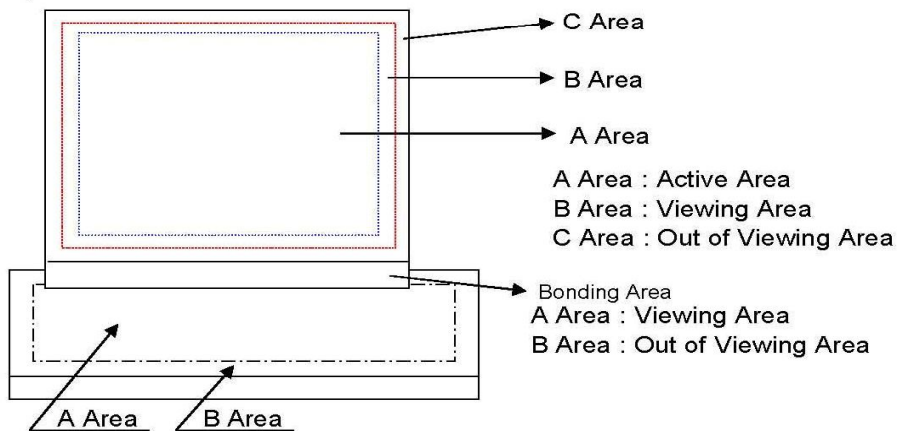

# SHENZHEN SUNFLY TECHNOLOGY CO., LTD.

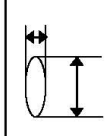
(3.3) Apperance Spec				Y																																												
No	Item	Criteria	Rank	Remark																																												
1	Segment Short Segment Missing	Not allowed	MA	X																																												
2	Solder Bridging	Any bridging between components, except common circuit, is not allowed.	MA																																													
3	Outside Dimension	Drawing & specification must be within permitable tolerance.    A Area    B Area	MA																																													
4	Cold Solder	Cold solder is not allowed.	MA																																													
5	Black(White) Spots, Foreign Substances	1) Round Type <table border="1" style="margin: 5px 0; width: 100%; border-collapse: collapse;"> <thead> <tr> <th style="width: 30%;">Area Dimension**</th> <th colspan="2" style="width: 40%;">Acceptable Q'ty</th> <th style="width: 30%;">Remark</th> </tr> </thead> <tbody> <tr> <td>≤ 0.1</td> <td colspan="2" style="text-align: center;">Ignore</td> <td rowspan="4"></td> </tr> <tr> <td>≤ 0.2</td> <td style="text-align: center;">2</td> <td style="text-align: center;">Ignore</td> </tr> <tr> <td>≤ 0.3</td> <td style="text-align: center;">1</td> <td style="text-align: center;">Ignore</td> </tr> <tr> <td>0.3 &lt;</td> <td style="text-align: center;">0</td> <td style="text-align: center;">Ignore</td> </tr> </tbody> </table> 2) Liner Type <table border="1" style="margin: 5px 0; width: 100%; border-collapse: collapse;"> <thead> <tr> <th colspan="2" style="width: 30%;">Dimension</th> <th colspan="2" style="width: 40%;">Acceptable Q'ty</th> <th style="width: 30%;">Remark</th> </tr> <tr> <th style="width: 15%;">Length</th> <th style="width: 15%;">Width</th> <th style="width: 15%;">A Area</th> <th style="width: 15%;">B Area</th> <td rowspan="5"></td> </tr> </thead> <tbody> <tr> <td style="text-align: center;">-</td> <td style="text-align: center;">≤ 0.025</td> <td colspan="2" style="text-align: center;">Ignore</td> </tr> <tr> <td style="text-align: center;">≤ 2.5</td> <td style="text-align: center;">≤ 0.05</td> <td style="text-align: center;">3</td> <td style="text-align: center;">Ignore</td> </tr> <tr> <td style="text-align: center;">≤ 1.5</td> <td style="text-align: center;">≤ 0.075</td> <td style="text-align: center;">2</td> <td style="text-align: center;">Ignore</td> </tr> <tr> <td></td> <td style="text-align: center;">0.075 &lt;</td> <td colspan="2" style="text-align: center;">Follow round type</td> </tr> </tbody> </table> <p style="margin-top: 5px;">At (1) &amp; (2) total defect q'ty is must not exceed 5 pieces.</p>	Area Dimension**	Acceptable Q'ty		Remark	≤ 0.1	Ignore			≤ 0.2	2	Ignore	≤ 0.3	1	Ignore	0.3 <	0	Ignore	Dimension		Acceptable Q'ty		Remark	Length	Width	A Area	B Area		-	≤ 0.025	Ignore		≤ 2.5	≤ 0.05	3	Ignore	≤ 1.5	≤ 0.075	2	Ignore		0.075 <	Follow round type		MI	 <p style="font-size: small;">** : Mean Diameter (X + Y)/2</p>	
Area Dimension**	Acceptable Q'ty		Remark																																													
≤ 0.1	Ignore																																															
≤ 0.2	2	Ignore																																														
≤ 0.3	1	Ignore																																														
0.3 <	0	Ignore																																														
Dimension		Acceptable Q'ty		Remark																																												
Length	Width	A Area	B Area																																													
-	≤ 0.025	Ignore																																														
≤ 2.5	≤ 0.05	3	Ignore																																													
≤ 1.5	≤ 0.075	2	Ignore																																													
	0.075 <	Follow round type																																														
6	OC Spot	<table border="1" style="margin: 5px 0; width: 100%; border-collapse: collapse;"> <thead> <tr> <th style="width: 30%;">Area Dimension**</th> <th colspan="2" style="width: 40%;">Acceptable Q'ty</th> <th style="width: 30%;">Remark</th> </tr> </thead> <tbody> <tr> <td>≤ 0.2</td> <td colspan="2" style="text-align: center;">Ignore</td> <td rowspan="4"></td> </tr> <tr> <td>≤ 0.8</td> <td style="text-align: center;">3</td> <td style="text-align: center;">Ignore</td> </tr> <tr> <td>≤ 1.0</td> <td style="text-align: center;">1</td> <td style="text-align: center;">Ignore</td> </tr> <tr> <td></td> <td></td> <td></td> </tr> </tbody> </table>	Area Dimension**	Acceptable Q'ty		Remark	≤ 0.2	Ignore			≤ 0.8	3	Ignore	≤ 1.0	1	Ignore				MI																												
Area Dimension**	Acceptable Q'ty		Remark																																													
≤ 0.2	Ignore																																															
≤ 0.8	3	Ignore																																														
≤ 1.0	1	Ignore																																														
7	Air Bubles Between Glass & Polarizer (Polarizer Defects)	<table border="1" style="margin: 5px 0; width: 100%; border-collapse: collapse;"> <thead> <tr> <th style="width: 30%;">Area Dimension**</th> <th colspan="2" style="width: 40%;">Acceptable Q'ty</th> <th style="width: 30%;">Remark</th> </tr> </thead> <tbody> <tr> <td>≤ 0.15</td> <td colspan="2" style="text-align: center;">Ignore</td> <td rowspan="5"></td> </tr> <tr> <td>≤ 0.3</td> <td style="text-align: center;">3</td> <td style="text-align: center;">Ignore</td> </tr> <tr> <td>≤ 0.5</td> <td style="text-align: center;">2</td> <td style="text-align: center;">Ignore</td> </tr> <tr> <td>≤ 0.7</td> <td style="text-align: center;">1</td> <td style="text-align: center;">Ignore</td> </tr> <tr> <td>Total</td> <td style="text-align: center;">5</td> <td style="text-align: center;">Ignore</td> </tr> </tbody> </table>	Area Dimension**	Acceptable Q'ty		Remark	≤ 0.15	Ignore			≤ 0.3	3	Ignore	≤ 0.5	2	Ignore	≤ 0.7	1	Ignore	Total	5	Ignore	MI																									
Area Dimension**	Acceptable Q'ty		Remark																																													
≤ 0.15	Ignore																																															
≤ 0.3	3	Ignore																																														
≤ 0.5	2	Ignore																																														
≤ 0.7	1	Ignore																																														
Total	5	Ignore																																														

# SHENZHEN SUNFLY TECHNOLOGY CO., LTD.

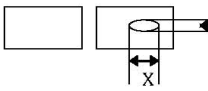
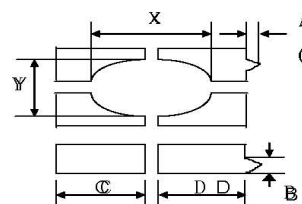
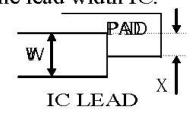
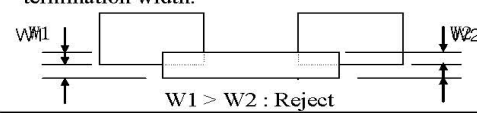
(3.3) Appearance Spec												
No	Item	Criteria	Rank	Remark								
8	Pin hole (On Segment)	 <p style="text-align: center;"> <math>(X+Y)/2 \leq 0.2\text{mm}</math>                      Within 1 per one                      segment ( Less than 0.1mm                      is not counted)                      Total defects q'ty is must not exceed 5 pieces.                 </p>	MI									
9	Segment Deformation	 <p style="text-align: center;"> <math>(X+Y)/2 \leq 0.2\text{mm}</math>  <math>A \leq 0.2\text{mm}</math>  <math>B \leq 0.2\text{mm}</math>  <math>(C-D) \leq 0.2\text{mm}</math> </p> <table border="1" style="margin-left: auto; margin-right: auto; border-collapse: collapse;"> <thead> <tr> <th></th> <th style="text-align: center;">Acceptable Q'ty</th> </tr> </thead> <tbody> <tr> <td style="text-align: center;">Dot, Segment</td> <td style="text-align: center;">1</td> </tr> <tr> <td style="text-align: center;">LCD</td> <td style="text-align: center;">5</td> </tr> <tr> <td style="text-align: center;"><math>\leq 0.1</math></td> <td style="text-align: center;">Ignore all defect</td> </tr> </tbody> </table> <p>Each visible dot must be more than half effective dot area</p>		Acceptable Q'ty	Dot, Segment	1	LCD	5	$\leq 0.1$	Ignore all defect	MI	$(X + Y)/2 \leq 0.2\text{mm}$
	Acceptable Q'ty											
Dot, Segment	1											
LCD	5											
$\leq 0.1$	Ignore all defect											
10	Color Variation	Within the three colors, except LCD Standard color is acceptable.	MI									
11	Glass & Polarizer Seratch	Follow NO.5(2) condition	MI									
12	Solder Ball	1)Acceptable if the size of void is less than 0.18mm 2)Acceptable if a solder ball is not movable 3)Rejectable if the solder ball exceed 5EA in $2.54 \times 2.54\text{mm}$ area.	MI									
13	Miss Alignment	1)Acceptable if it dose not exceed 50% of the lead width IC.  <p style="text-align: center;"> <math>X \leq W/2</math> : Accept  <math>X &gt; W/2</math> : Reject                 </p> 2)Rejectable, provided that it does exceed 50% of the component termination width.  <p style="text-align: center;"><math>W1 &gt; W2</math> : Reject</p>										

Note : A limitation sample is given top priority

(3.3) Appearance Spec

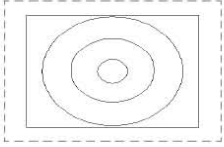
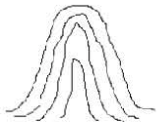
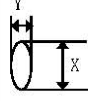
No	Item	Criteria	Rank	Remark																																																
14	Touch Panel	<p>1) Round Type、 Foreign Substances</p> <table border="1" style="margin-left: 20px; border-collapse: collapse;"> <thead> <tr> <th rowspan="2">Area Dimension**</th> <th colspan="2">Acceptable Q'ty</th> <th rowspan="2">Remark</th> </tr> <tr> <th>A Area</th> <th>B Area</th> </tr> </thead> <tbody> <tr> <td>≤ 0.1</td> <td colspan="2" style="text-align: center;">Ignore</td> <td rowspan="4"></td> </tr> <tr> <td>≤ 0.2</td> <td style="text-align: center;">2</td> <td style="text-align: center;">Ignore</td> </tr> <tr> <td>≤ 0.3</td> <td style="text-align: center;">1</td> <td style="text-align: center;">Ignore</td> </tr> <tr> <td>0.3 &lt;</td> <td style="text-align: center;">0</td> <td style="text-align: center;">Ignore</td> </tr> </tbody> </table> <p>2) Liner Type &amp; Scratch</p> <table border="1" style="margin-left: 20px; border-collapse: collapse;"> <thead> <tr> <th colspan="2">Dimension</th> <th colspan="2">Acceptable Q'ty</th> <th rowspan="2">Remark</th> </tr> <tr> <th>Length</th> <th>Width</th> <th>A Area</th> <th>B Area</th> </tr> </thead> <tbody> <tr> <td>-</td> <td>W ≤ 0.025</td> <td colspan="2" style="text-align: center;">Ignore</td> <td rowspan="5" style="text-align: center;">Ignore</td> </tr> <tr> <td>L ≤ 3.0</td> <td rowspan="2">W ≤ 0.05</td> <td colspan="2" style="text-align: center;">Ignore</td> </tr> <tr> <td>3.0 &lt; L ≤ 5.0</td> <td colspan="2" style="text-align: center;">2</td> </tr> <tr> <td>≤ 7</td> <td>W ≤ 0.1</td> <td colspan="2" style="text-align: center;">1</td> </tr> <tr> <td>-</td> <td>W &gt; 0.1</td> <td colspan="2" style="text-align: center;">Follow round type</td> </tr> </tbody> </table> <p>4) Newton Ring</p> <p>a) Regular</p> <div style="text-align: center; margin: 10px 0;">  </div> <p>The area of the Newton ring is more than 1/3 area of the touch panel It's NG. The area of the Newton ring is less than 1/3 area of the touch panel It's OK.</p> <p>b) None-regularity</p> <div style="text-align: center; margin: 10px 0;">  </div> <p>The area of the Newton ring is more than 1/2 area of the touch panel It's NG. The area of the Newton ring is less than 1/2 area of the touch panel It's OK.</p>	Area Dimension**	Acceptable Q'ty		Remark	A Area	B Area	≤ 0.1	Ignore			≤ 0.2	2	Ignore	≤ 0.3	1	Ignore	0.3 <	0	Ignore	Dimension		Acceptable Q'ty		Remark	Length	Width	A Area	B Area	-	W ≤ 0.025	Ignore		Ignore	L ≤ 3.0	W ≤ 0.05	Ignore		3.0 < L ≤ 5.0	2		≤ 7	W ≤ 0.1	1		-	W > 0.1	Follow round type		MI	 <p>** : Mean Diameter (X + Y)/2</p>
Area Dimension**	Acceptable Q'ty			Remark																																																
	A Area	B Area																																																		
≤ 0.1	Ignore																																																			
≤ 0.2	2	Ignore																																																		
≤ 0.3	1	Ignore																																																		
0.3 <	0	Ignore																																																		
Dimension		Acceptable Q'ty		Remark																																																
Length	Width	A Area	B Area																																																	
-	W ≤ 0.025	Ignore		Ignore																																																
L ≤ 3.0	W ≤ 0.05	Ignore																																																		
3.0 < L ≤ 5.0		2																																																		
≤ 7	W ≤ 0.1	1																																																		
-	W > 0.1	Follow round type																																																		

## 12. BHL&BMDT Customer Quality Service Process

### 12. BHL&BMDT Customer Quality Service Process

In order to provide better service to Customer, BHL&BMDT shall apply the after-sales product quality service process as below:

1. According to the P/O from Customer, BHL&BMDT should deliver required product to the place appointed by Customer.
2. Customer will do IQC for the incoming product.
3. Inspection standard should be provided by BHL&BMDT, and it will be valid after confirmed by Customer. Inspection and Defects determination should be carried out according to the standard agreed by both Parties.
4. In order to guarantee in-time communication of product quality information and effective service, QA staff on Customer side should send Weekly Quality Report to the appointed CS staff in BHL&BMDT.
5. After BHL&BMDT get related information, both sides should arrange time and place to determine the defects found by Customer.
6. BHL&BMDT should cooperate with Customer for special quality requirement.
7. After confirmed by both side, BHL&BMDT should be responsible for the defect products which caused by its quality problem. BHL&BMDT should take back the confirmed defect product and return the good product to the place required by customer.
8. BHL&BMDT agree to provide related training of LCD product technology and usage.
9. Customer should use the LCD product according to the instruction. BHL&BMDT will not be responsible for the defect product caused by violation of Users' Instruction.
10. Both parties should deal with the quality problem with friendly cooperative policy. And both parties should negotiate to deal with the defect products of which the responsibility is not very clear.

## 13. LCD Module Operation Instruction

### 13. LCD Module Operation Instruction

#### BHL&BMDT

##### Part I. How to use the LCD Module

1. Don't hit the LCD Panel in any way because the LCD is made of glass.
2. Don't clean the surface of LCD with hard things. Please clean LCD with Air-gun or very soft cloth when necessary. The protective film on the POL can be removed just before assembly, otherwise, dust, spit or other foreign matter may attached on the LCD under the protective film. After the protective film is removed, only air-gun can be used to remove any dust or foreign matter. Fingure or cloth MUST NOT be used in such cases.
3. No chemical liquid is allowed to clean the LCD, such as alcohol, acetone and IPA. All of these can damage the LCD. Water on the LCD must be cleaned as soon as possible, for it will cause POL color change or other defect.
4. Please move and assemble LCD very carefully during assembly, and don't push or twist it.
5. Don't damage the FPC of LCD module. It will cause permanent defect.
6. Don't disassemble LCD module. It will cause permanent defect.
7. Don't expose LCD module under sunshine, strong fluorescence or ultraviolet radiation.
8. Please make sure that operators wear static-protective bands effectively and working tables are effectively earthing during operation.
9. Please place LCD module on the tray provided by BHL&BMDT while moving it, in order to avoid mechanical damage. Hold the module's side frames to avoide damage during moving.
10. Don't twist, disassemble, squeeze or hit the PCB. It will damage the circuit or component on PCB and cause functional defect.
11. Please use the connector according to the instruction provided by BHL&BMDT.
12. Please place dual module with the sub-panel upward. Trays should be placed in contrary direction. An empty tray should be placed on the top.
13. Sealing operation on PCB must be very careful to avoid short or cut the original circuit on PCB. Otherwise, it will cause permanant damage to the LCD.
14. Don't add direct DC or high voltage to LCD panel. It will cause functional damage to the LCD or shorten the life of LCD product.
15. LCD may respond slowly or display abnormally in extrem temperature (lower than -20°C or higher than 50°C). But this doesn't mean LCD functional defect. LCD will display normally in regular temperature. Therefore, don't use LCD product in extrem temperature.
16. Don't push the display area of LCD panel, it will cause abnormal display. This doesn't mean LCD functional defect, neither. LCD will display normally in regular temperature.
17. Electrical test of LCD product is made by using mobile phone provided by Customer. We can use special test equipment to do the test, also.
18. The black band on IC on LCD product is used to protect the IC from light. Please do NOT remove it.
19. Please take great care to use connector. Customer should be responsible for connector defect caused by operation on Customer side.

## Part II Storage

1. Physical status of liquid crystal will change in extrem temperature, and it can not be resumed when the temperature returns to be normal. So LCD module should be stored in required temperature.
2. LCD module should be stored in required humidity. Low humidity may add static, while high humidity may corrode the ITO circuit of LCD product. The suitable storage environment is: temperature:  $22\pm 5^{\circ}\text{C}$ , humidity:  $55\%\pm 10\%$ .
3. Don't expose LCD module under sunshine, strong fluorescence or ultraviolet radiation for a long time. It should be stored in dark area.
4. LCD should be stored in static-protective polythene bag. Don't expose it in the air for a long time.