

Z8001®/Z8002®
Military Z8000® CPU
Central Processing Unit

T-49-17-07

Zilog

Military
Electrical
Specification

September 1988

FEATURES

- Regular, easy-to-use architecture
- Instruction set more powerful than many minicomputers
- Directly addresses 8 Mbytes
- Eight user-selectable addressing modes
- Seven data types that range from bits to 32-bit long words and byte and word strings
- System and Normal operating modes
- Separate code, data, and stack spaces
- Sophisticated interrupt structure
- Resource-shaping capabilities for multiprocessing systems
- Multi-programming support
- Compiler support
- Memory management and protection provided by Z8010™ Memory Management Unit
- 32-bit operations, including signed multiply and divide
- Z-BUS® compatible
- 4, 6, and 10 MHz clock rate

GENERAL DESCRIPTION

The Z8000 is an advanced high-end 16-bit microprocessor that spans a wide variety of applications ranging from simple stand-alone computers to complex parallel-processing systems. Essentially a monolithic minicomputer central processing unit, the Z8000 CPU is characterized by an instruction set more powerful than many minicomputers; abundant resources in registers, data types, addressing modes and addressing range, and a regular architecture that enhances throughput by avoiding critical bottlenecks such as implied or dedicated registers.

CPU resources include sixteen 16-bit general-purpose registers, seven data types that range from bits to 32-bit long words and byte and word strings, and eight user-selectable addressing modes. The 110 distinct instruction types can be combined with the various data types and addressing modes to form a powerful set of 414 instructions. Moreover, the instruction set is regular; most instructions can use any

of the five main addressing modes and can operate on byte, word, and long-word data types.

The CPU can operate in either the system or normal mode. The distinction between these two modes permits privileged operations, thereby improving operating system organization and implementation. Multiprogramming is supported by the "atomic" Test and Set instruction; multiprocessing by a combination of instruction and hardware features; and compilers by multiple stacks, special instructions, and addressing modes.

The Z8000 CPU is offered in two versions: the Z8001 segmented CPU and the Z8002 nonsegmented CPU. The main difference is in addressing range. The Z8001 can directly address 8 megabytes of memory; the Z8002 directly addresses 64 kilobytes. The two operating modes—system and normal—and the distinction between code,

data, and stack spaces within each mode allows memory extension up to 48 megabytes for the Z8001 and 384 kilobytes for the Z8002.

To meet the requirements of complex, memory-intensive applications, a companion memory-management device is offered for the Z8001. The Z8010 Memory Management Unit manages the large address space by providing features such as segment relocation and memory protection.

The Z8001 can be used with or without the Z8010. If used by itself, the Z8001 still provides an 8 megabyte direct addressing range, extendable to 48 megabytes.

The Z8001, Z8002, and Z8010 are fabricated with high-density, high-performance scaled n-channel silicon-gate depletion-load technology, and are housed in dual-in-line packages (DIPS) and leadless chip carriers (LCC).

Z8000 CPU TIMING

The Z8000 CPU executes instructions by stepping through sequences of basic machine cycles, such as memory read or write, I/O device read or write, interrupt acknowledge, and internal execution. Each of these basic cycles requires three to ten clock cycles to execute. Instructions that require more clock cycles to execute are broken up into several machine cycles. Thus no machine cycle is longer than ten clock cycles and fast response to a Bus Request is guaranteed.

The instruction opcode is fetched by a normal memory read operation. A memory refresh cycle can be inserted just after the completion of any first instruction fetch (IF₁) cycle and can also be inserted while the following instructions are being executed: MULT, MULTL, DIV, DIVL, HALT, all Shift instructions, all Block Move instructions, and the Multi-Micro

Request instruction (MREQ).

The following timing diagrams show the relative timing relationships of all CPU signals during each of the basic operations. When a machine cycle requires additional clock cycles for CPU internal operation, one to five clock cycles are added. Memory and I/O read and write, as well as interrupt acknowledge cycles, can be extended by activating the $\overline{\text{WAIT}}$ input. For exact timing information, refer to the composite timing diagram.

Note that the $\overline{\text{WAIT}}$ input is not synchronized in the Z8000 and that the setup and hold times for $\overline{\text{WAIT}}$, relative to the clock, must be met. If asynchronous $\overline{\text{WAIT}}$ signals are generated, they must be synchronized with the CPU clock before entering the Z8000.

MEMORY READ AND WRITE

T-49-17-07

Memory read and instruction fetch cycles are identical, except for the status information on the ST₀-ST₃ outputs. During a memory read cycle, a 16-bit address is placed on the AD₀-AD₁₅ outputs early in the first clock period, as shown in Figure 1. In the Z8001, the 7-bit segment number is output on SN₀-SN₆ one clock period earlier than the 16-bit address offset.)

A valid address is indicated by the rising edge of Address Strobe. Status and mode information become valid early in the memory access cycle and remain stable throughout. The state of the WAIT input is sampled in the middle of the second clock cycle by the falling edge of Clock. If WAIT is

Low, an additional clock period is added between T₂ and T₃. WAIT is sampled again in the middle of this wait cycle, and additional wait states can be inserted: this allows interfacing slow memories. No control outputs change during wait states.

Although Z8000 memory is word organized, memory is addressed as bytes. All instructions are word-aligned, using even addresses. Within a 16-bit word, the most significant byte (D₈-D₁₅) is addressed by the low-order address (A₀ = Low), and the least significant byte (D₀-D₇) is addressed by the high-order address (A₀ = High).

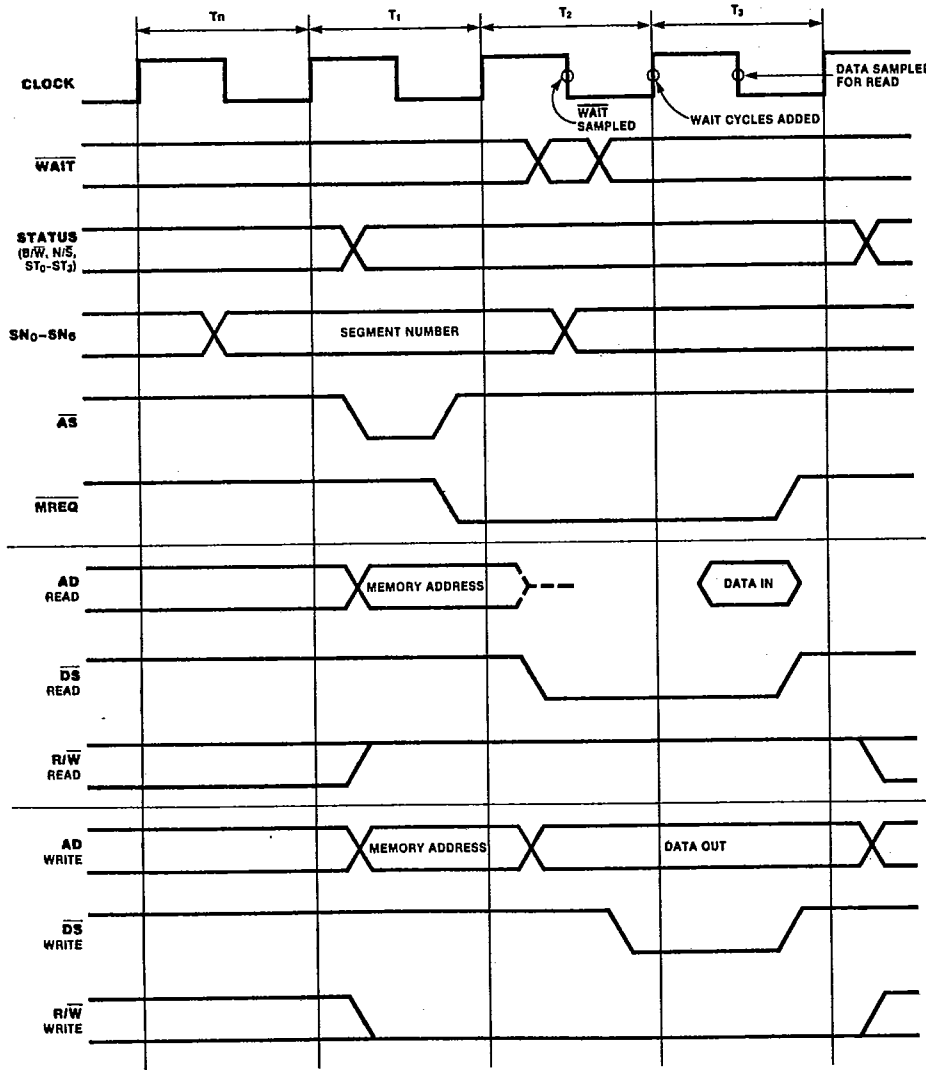

Figure 1. Memory Read and Write Timing

INPUT/OUTPUT

T-49-17-07

I/O timing is similar to memory read/write timing, except that one wait state is automatically (T_{WA}) inserted between T_2 and T_3 (Figure 2). Both the segmented Z8001 and the nonsegmented Z8002 use 16-bit I/O addresses.

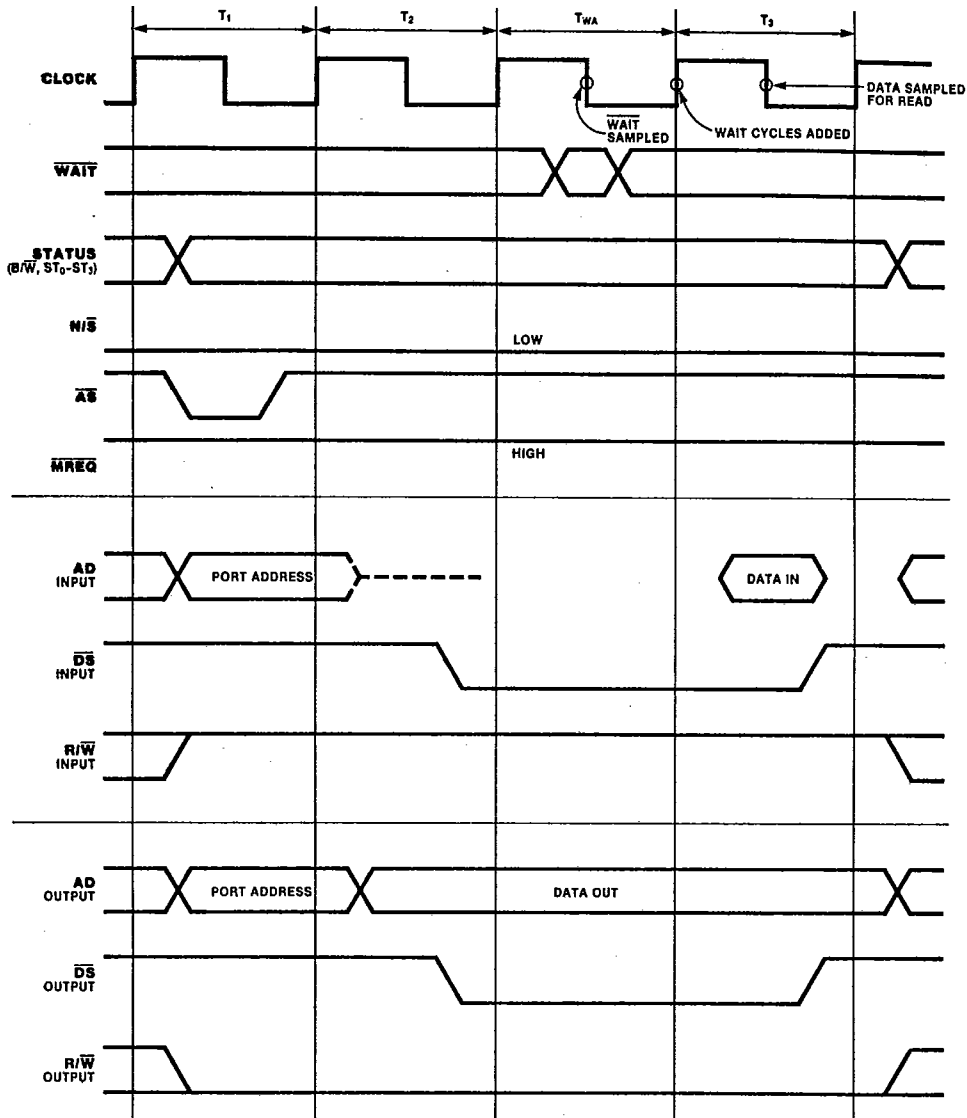

Figure 2. Input/Output Timing

INTERRUPT AND SEGMENT TRAP REQUEST AND ACKNOWLEDGE

The Z8000 CPU recognizes three interrupt inputs (non-maskable, vectored, and nonvectored) and a segmentation trap input. Any High-to-Low transition on the NMI input is asynchronously edge detected and sets the internal NMI latch. The VI, NVI, and SEGT inputs, as well as the state of the internal NMI latch, are sampled at the end of T₂ in the last machine cycle of any instruction.

In response to an interrupt or trap, the subsequent IF₁ cycle is exercised, but ignored. The internal state of the CPU is not altered and the instruction will be refetched and executed after the return from the interrupt routine. The program counter is not updated, but the system stack pointer is decremented in preparation for pushing starting information onto the system stack.

The next machine cycle is the interrupt acknowledge cycle.

This cycle has five automatic wait states, with additional wait states possible, as shown in Figure 3.

After the last wait state, the CPU reads the information on AD₀-AD₁₅ and temporarily stores it, to be saved on the stack later in the acknowledge sequence. This word identifies the source of the interrupt or trap. For the nonvectored and nonmaskable interrupts, all 16 bits can represent peripheral device status information. For the vectored interrupt, the low byte is the jump vector, and the high byte can be extra user status. For the segmentation trap, the *high* byte is the Memory Management Unit identifier and the *low* byte is undefined.

After the acknowledge cycle, the N/S output indicates the automatic change to system mode.

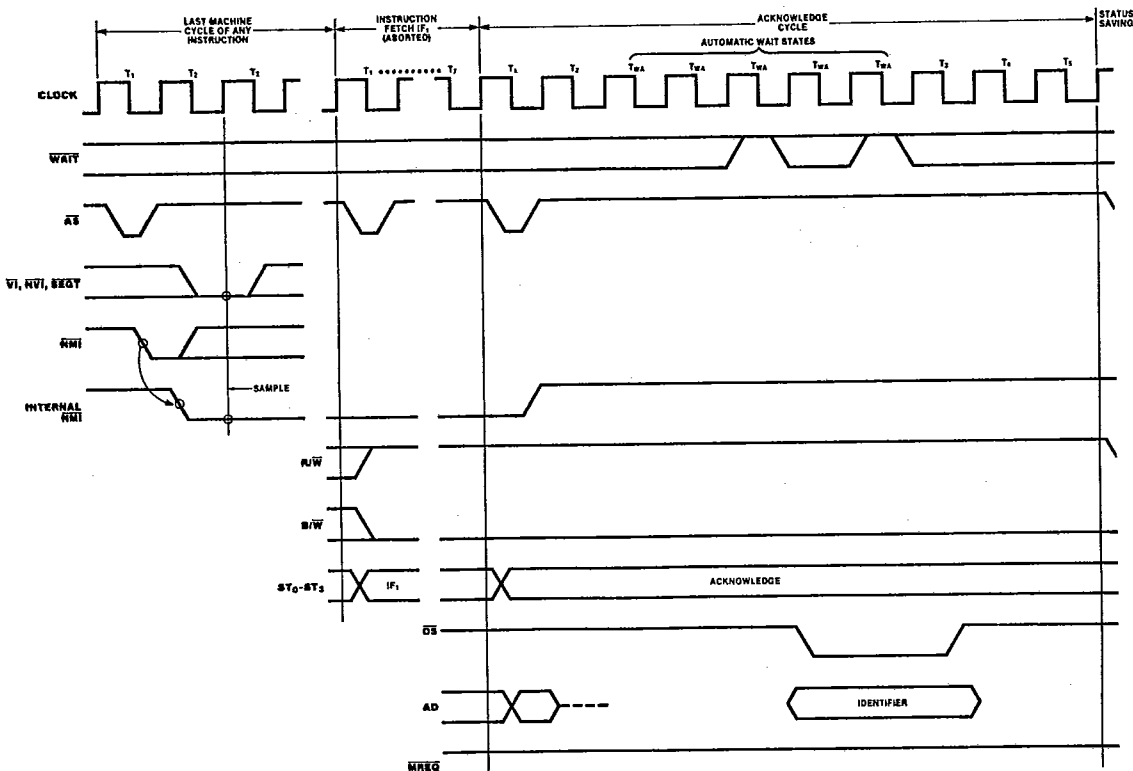

Figure 3. Interrupt and Segment Trap Request/Acknowledge Timing

STATUS SAVING SEQUENCE

T-49-17-07

The machine cycles, following the interrupt acknowledge or segmentation trap acknowledge cycle, push the old status information on the system stack in the following order: the 16-bit program counter; the 7-bit segment number (Z8001

only); the flag control word; and finally the interrupt/trap identifier. Subsequent machine cycles fetch the new program status from the program status area, and then branch to the interrupt/trap service routine.

BUS REQUEST ACKNOWLEDGE TIMING

A Low on the $\overline{\text{BUSREQ}}$ input indicates to the CPU that another device is requesting the Address/Data and control buses. The asynchronous $\overline{\text{BUSREQ}}$ input is synchronized at the beginning of any machine cycle (Figure 4). $\overline{\text{BUSREQ}}$ takes priority over $\overline{\text{WAIT}}$. If $\overline{\text{BUSREQ}}$ is Low, an internal synchronous $\overline{\text{BUSREQ}}$ signal is generated, which—after completion of the current machine cycle—causes the $\overline{\text{BUSACK}}$ output to go Low and all bus outputs to go into the

high-impedance state. The requesting device—typically a DMA—can then control the bus.

When $\overline{\text{BUSREQ}}$ is released, it is synchronized with the rising clock edge; the $\overline{\text{BUSACK}}$ output goes High one clock period later, indicating that the CPU will again take control of the bus.

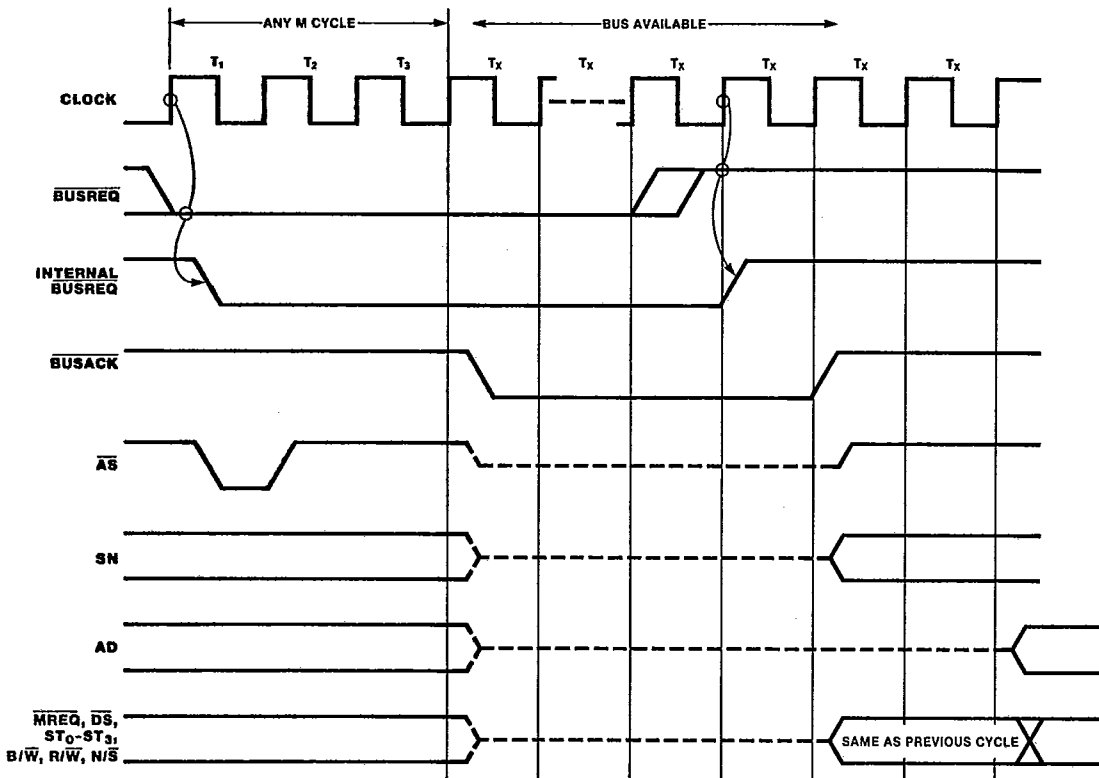

Figure 4. Bus Request/Acknowledge Timing

STOP

T-49-17-07

The \overline{STOP} input is sampled by the last falling clock edge immediately preceding any IF_1 cycle (Figure 5) and before the second word of an EPA instruction is fetched. If \overline{STOP} is found Low during the IF_1 cycle, a stream of memory refresh cycles is inserted after T_3 , again sampling the \overline{STOP} input on each falling clock edge in the middle of the T_3 states. During the EPA instruction, both EPA instruction words are fetched but any data transfer or subsequent instruction fetch is

postponed until \overline{STOP} is sampled High. This refresh operation does not use the refresh prescaler or its divide-by-four clock prescaler; rather, it double-increments the refresh counter every three clock cycles. When \overline{STOP} is found High again, the next refresh cycle is completed, any remaining T states of the IF_1 cycle are then executed, and the CPU continues its operation.

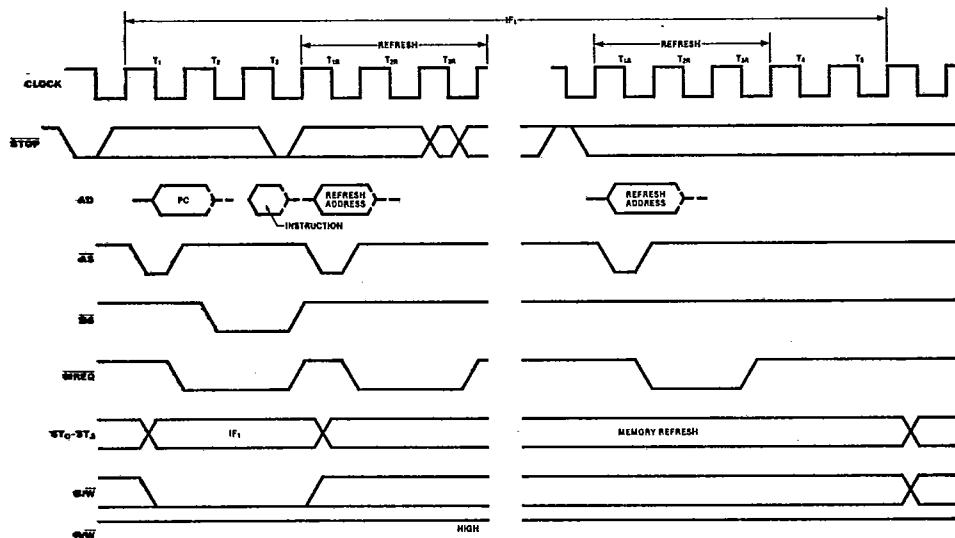

Figure 5. Stop Timing

INTERNAL OPERATION

T-49-17-07

Certain extended instructions, such as Multiply and Divide, and some special instructions need additional time for the execution of internal operations. In these cases, the CPU goes through a sequence of internal operation machine

cycles, each of which is three to eight clock cycles long (Figure 6). This allows fast response to Bus Request and Refresh Request, because bus request or refresh cycles can be inserted at the end of any internal machine cycle.

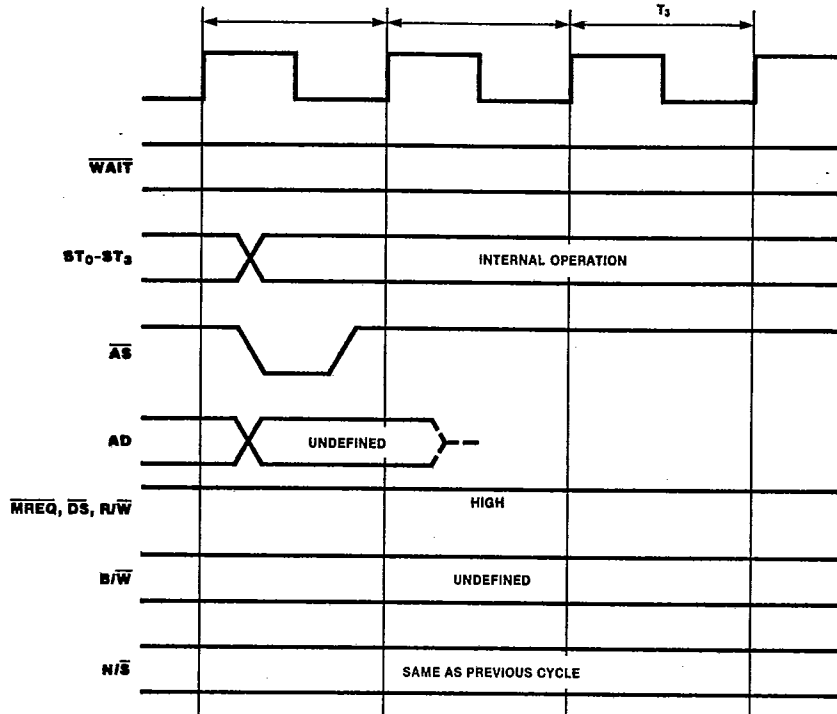

Figure 6. Internal Operation Timing

HALT

A HALT instruction executes an unlimited number of 3-cycle internal operations, interspersed with memory refresh cycles whenever requested. An interrupt, segmentation trap, or reset are the only exits from a HALT instruction.

The CPU samples the \overline{VI} , \overline{NVI} , \overline{NMI} , and \overline{SEGT} inputs at the beginning of every T_3 cycle. If an input is found active during two consecutive samples, the subsequent IF_1 cycle is exercised, but ignored, and the normal interrupt acknowledge cycle is started.

MEMORY REFRESH

T-49-17-07

When the 6-bit prescaler in the refresh counter has been decremented to zero, a refresh cycle consisting of three T-states is started as soon as possible (that is, after the next IF_1 cycle or Internal Operation cycle).

The 9-bit refresh counter value is put on the low-order side of the address bus (AD_0-AD_8); AD_9-AD_{15} are undefined (Figure 7). Since the memory is word-organized, A_0 is always Low during refresh and the refresh counter is always

incremented by two, thus stepping through 256 consecutive refresh addresses on AD_1-AD_8 . Unless disabled, the presetable prescaler runs continuously and the delay in starting a refresh cycle is therefore not cumulative.

While the \overline{STOP} input is Low, a continuous stream of memory refresh cycles, each three T-states long, is executed without using the refresh prescaler.

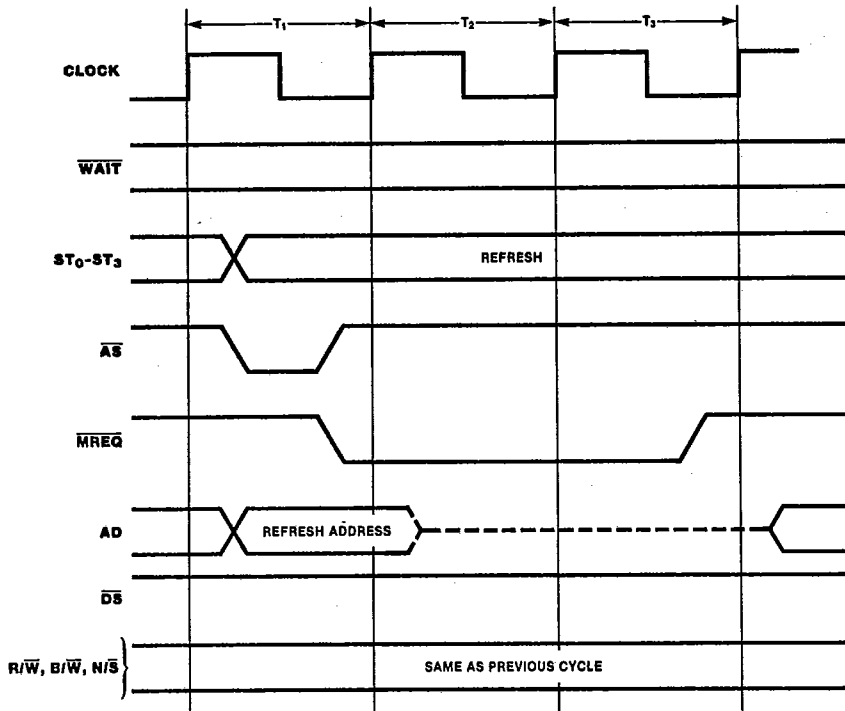

Figure 7. Memory Refresh Timing

RESET

A Low on the \overline{RESET} input causes the following results within five clock cycles (Figure 8):

- AD_0-AD_{15} are 3-stated
- \overline{AS} , \overline{DS} , \overline{MREQ} , ST_0-ST_3 , \overline{BUSACK} , and \overline{MO} are forced High
- SN_0-SN_6 are forced Low
- Refresh is disabled
- R/\overline{W} , B/\overline{W} , and N/\overline{S} are not affected

When \overline{RESET} has been High for three clock periods, three consecutive memory read cycles are executed in the system mode for the Z8001. The Z8002 has two consecutive read cycles. In the Z8001 the first cycle reads the flag and control word from location 0002, the next reads the 7-bit program counter segment number from location 0004, the next reads the 16-bit PC offset from location 0006, and the following IF_1 cycle starts the program. In the Z8002, the first cycle reads the flag and control word from location 0002, the next reads the PC from location 0004, and the following IF_1 cycle starts the program.

T-49-17-07

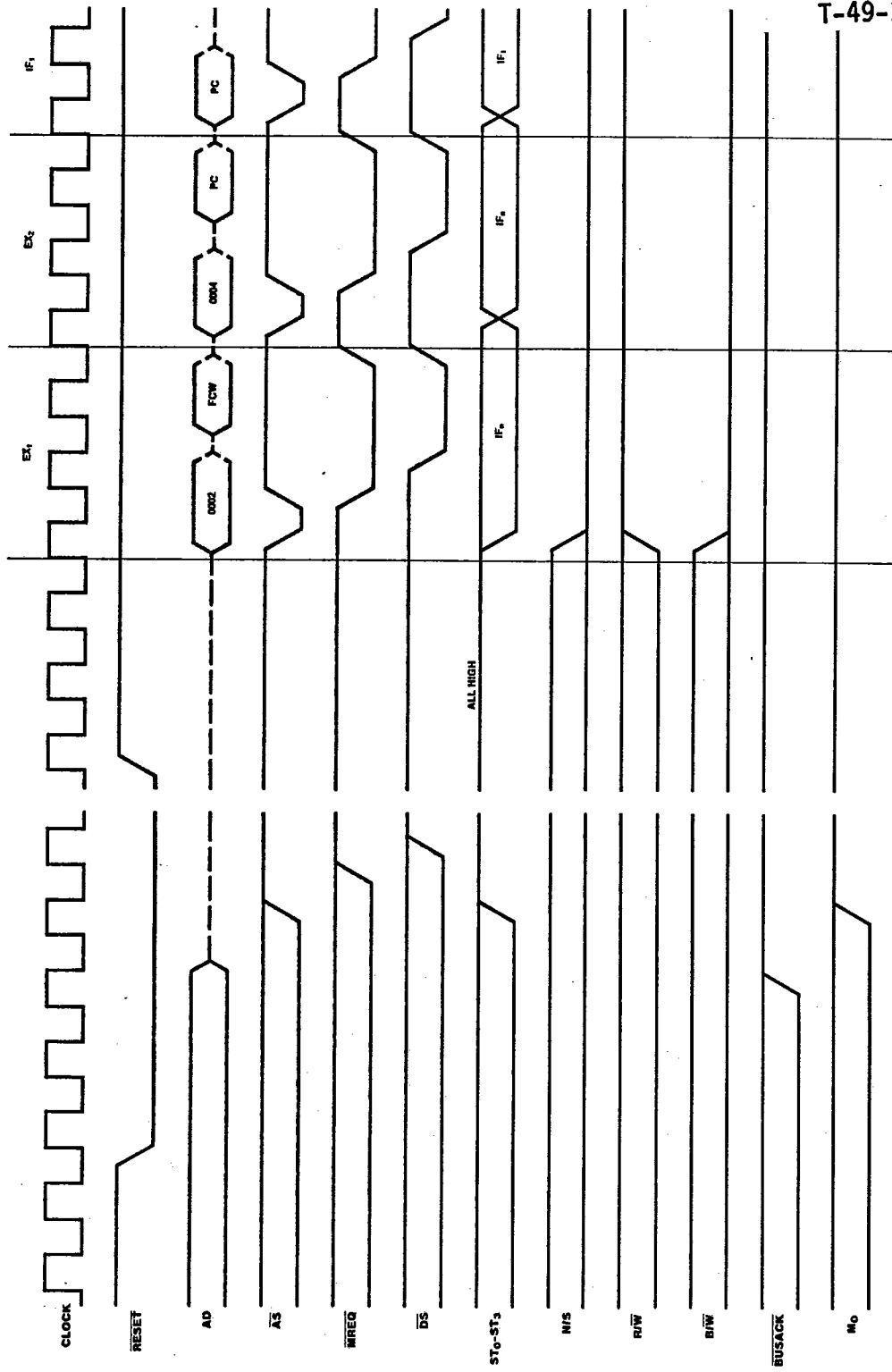

COMPOSITE AC TIMING DIAGRAM

T-49-17-07

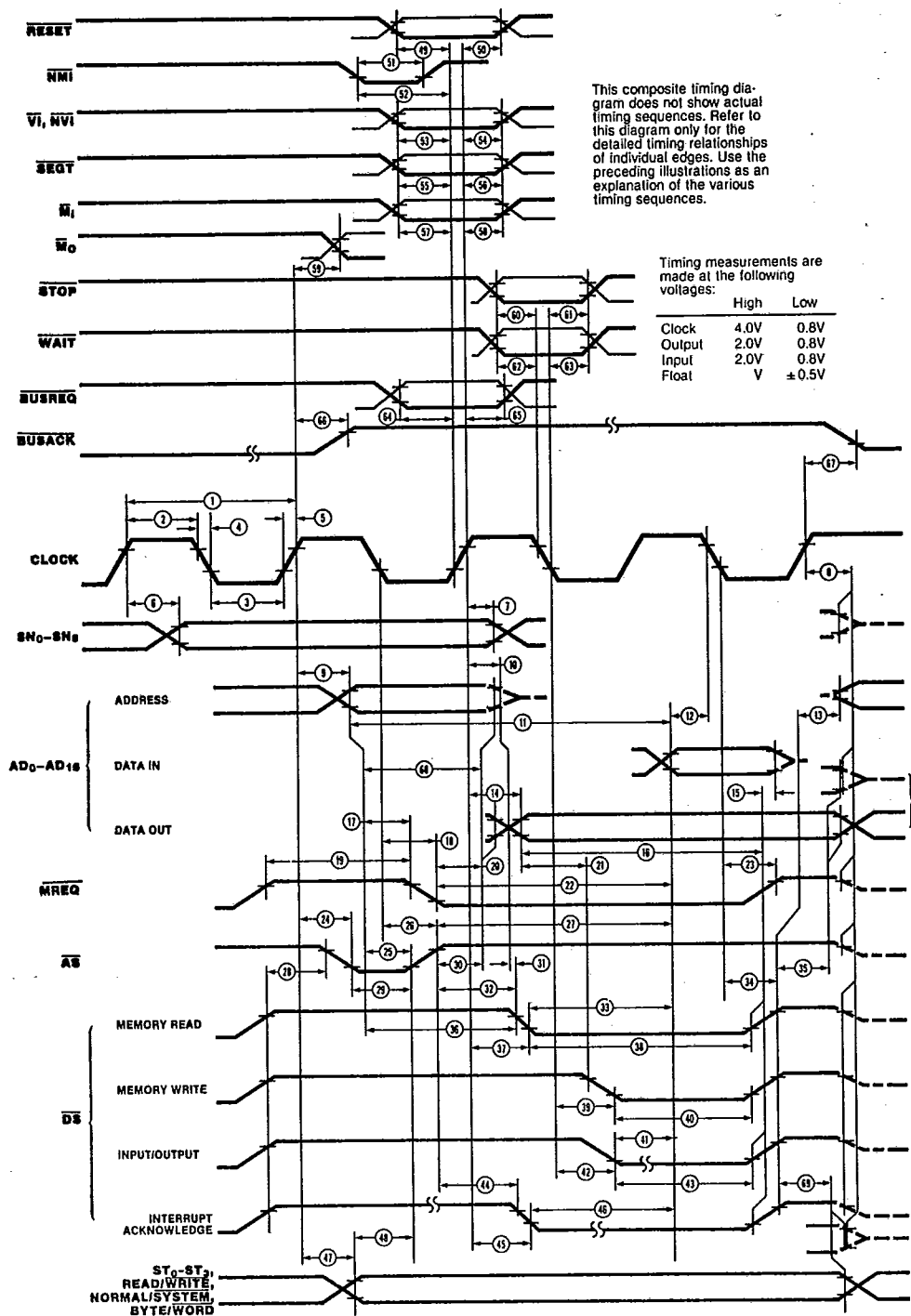

ABSOLUTE MAXIMUM RATINGS

Guaranteed by characterization/design.

Voltages on all pins with respect to GND -0.3V to +7.0V
 Operating Case Temperature -55°C to +125°C
 Storage Temperature -65°C to +150°C
 Absolute Maximum Power Dissipation 2.25W
 Solder Temperature 270°C for 5 sec.

T-49-17-07

Stresses greater than those listed under Absolute Maximum Ratings may cause permanent damage to the device. This is a stress rating only; operation of the device at any condition above those indicated in the operational sections of these specifications is not implied. Exposure to absolute maximum rating conditions for extended periods may affect device reliability.

STANDARD TEST CONDITIONS

The DC Characteristics section listed below applies for the following standard test conditions, unless otherwise noted.

Military Operating Temperature Range (T_C)
 -55°C to +125°C

Standard Military Test Condition
 +4.5V ≤ V_{CC} ≤ +5.5V

All voltages are referenced to GND (0V). Positive current flows into the referenced pin.

All AC parameters assume a total load capacitance (including parasitic capacitances) or 100 pf max, except for parameter 6 (50 pf max). Timing references between two output signals assume a load difference of 50 pf max.

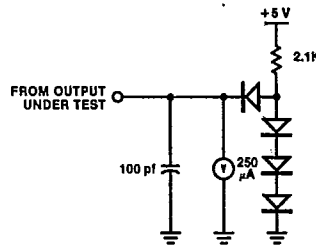

DC CHARACTERISTICS

Symbol	Parameter	Min	Max	Unit	Condition
V _{CH}	Clock Input High Voltage	V _{CC} - 0.4 ^a	V _{CC} + 0.3 ^c	V	Driven by External Clock Generator
V _{CL}	Clock Input Low Voltage	-0.3 ^c	0.45 ^a	V	Driven by External Clock Generator
V _{IH}	Input High Voltage	2.2 ^a	V _{CC} + 0.3 ^c	V	
V _{IH} RESET	Input High Voltage on RESET pin	2.4 ^a	V _{CC} + 0.3 ^c	V	
V _{IH} NMI	Input High Voltage on NMI pin	2.4 ^a	V _{CC} + 0.3 ^c	V	
V _{IL}	Input Low Voltage	-0.3 ^c	0.8 ^a	V	
V _{OH}	Output High Voltage	2.4 ^a		V	I _{OH} = -250 μA
V _{OL}	Output Low Voltage		0.4 ^a	V	I _{OL} = +2.0 mA
I _{IL}	Input Leakage		±10 ^a	μA	0.4 ≤ V _{IN} ≤ +2.4V
I _{IL} SEGT	Max Input Current on SEGT pin (8001 only)		200 ^a	μA	
I _{OL}	Output Leakage		±10 ^a	μA	0.4 ≤ V _{IN} ≤ +2.4V
I _{CC}	V _{CC} Power Supply Current		400 ^a	mA	4,6 and 10 MHz

Parameter Test Status:

- ^a Tested
- ^b Guaranteed
- ^c Guaranteed by Characterization/Design

AC CHARACTERISTICS†

T-49-17-07

Number	Symbol	Parameter	Z8001/2 4 MHz		Z8001/2 6 MHz		Z8001/2 10 MHz	
			Min	Max	Min	Max	Min	Max
1	TcC	Clock Cycle Time	250 ^a	2000 ^a	165 ^a	2000 ^a	100 ^a	2000 ^a
2	TwCh	Clock Width (High)	105 ^a		70 ^a		40 ^a	
3	TwCl	Clock Width (Low)	105 ^a		70 ^a		40 ^a	
4	TfC	Clock Fall Time		20 ^a		15 ^a		10 ^a
5	TrC	Clock Rise Time		20 ^a		15 ^a		10 ^a
6	TdC(SNv)	Clock ↑ to Segment Number Valid (50 pf load) (8001 only)		130 ^a		110 ^a		80 ^a
7	TdC(SNn)	Clock ↑ to Segment Number Not Valid (8001 only)	20 ^a		10 ^a		0 ^a	
8	TdC(Bz)	Clock ↑ to Bus Float		65 ^c		55 ^c		50 ^c
9	TdC(A)	Clock ↑ to Address Valid		100 ^a		75 ^a		55 ^a
10	TdC(Az)	Clock ↑ to Address Float		65 ^c		55 ^c		50 ^c
11	TdA(DR)	Address Valid to Read Data Required Valid		475 ^{d*}		305 ^{d*}		180 ^{d*}
12	TsDR(C)	Read Data to Clock ↓ Setup time	30 ^a		20 ^a		10 ^a	
13	TdDS(A)	\overline{DS} ↑ to Address Active	80 ^{d*}		45 ^{d*}		20 ^{d*}	
14	TdC(DW)	Clock ↑ to Write Data Valid		100 ^a		75 ^a		60 ^a
15	ThDR(DS)	Read Data to \overline{DS} ↑ Hold Time	0 ^a		0 ^a		0 ^a	
16	TdDW(DS)	Write Data Valid to \overline{DS} ↑ Delay	295 ^{d*}		195 ^{d*}		110 ^{d*}	
17	TdA(MR)	Address Valid to \overline{MREQ} ↓ Delay	55 ^{d*}		35 ^{d*}		20 ^{d*}	
18	TdC(MR)	Clock ↓ to \overline{MREQ} ↓ Delay		80 ^a		70 ^a		40 ^a
19	TwMRh	\overline{MREQ} Width (High)	210 ^{d*}		135 ^{d*}		80 ^{d*}	
20	TdMR(A)	\overline{MREQ} ↓ to Address Not Active	70 ^{d*}		35 ^{d*}		20 ^{d*}	
21	TdDW(DSW)	Write Data Valid to \overline{DS} ↓ (Write) Delay	55 ^{d*}		35 ^{d*}		15 ^{d*}	
22	TdMR(DR)	\overline{MREQ} ↓ to Read Data Required Valid		370 ^{d*}		230 ^{d*}		140 ^{d*}
23	TdC(MR)	Clock ↓ \overline{MREQ} ↑ Delay		80 ^a		60 ^a		45 ^a
24	TdC(ASf)	Clock ↑ to \overline{AS} ↓ Delay		80 ^a		60 ^a		40 ^a
25	TdA(AS)	Address Valid to \overline{AS} ↑ Delay	55 ^{d*}		35 ^{d*}		20 ^{d*}	
26	TdC(ASr)	Clock ↓ to \overline{AS} ↑ Delay		90 ^a		80 ^a		40 ^a
27	TdAS(DR)	\overline{AS} ↑ to Read Data Required Valid		360 ^{d*}		220 ^{d*}		140 ^{d*}
28	TdDS(AS)	\overline{DS} ↑ to \overline{AS} ↓ Delay	70 ^{d*}		35 ^{d*}		15 ^{d*}	
29	TwAS	\overline{AS} Width (Low)	85 ^{d*}		55 ^{d*}		30 ^{d*}	
30	TdAS(A)	\overline{AS} ↑ to Address Not Active Delay	70 ^{d*}		45 ^{d*}		20 ^{d*}	
31	TdAz(DSR)	Address Float to \overline{DS} (Read) ↓ Delay	0 ^c		0 ^c		0 ^c	
32	TdAS(DSR)	\overline{AS} ↑ to \overline{DS} (Read) ↓ Delay	80 ^{d*}		55 ^{d*}		30 ^{d*}	
33	TdDSR(DR)	\overline{DS} (Read) ↓ to Read Data Required Valid		205 ^{d*}		130 ^{d*}		70 ^{d*}
34	TdC(DSr)	Clock ↓ to \overline{DS} ↑ Delay		70 ^a		65 ^a		45 ^a
35	TdDS(DW)	\overline{DS} ↑ to Write Data Not Valid	75 ^{d*}		45 ^{d*}		25 ^{d*}	

*Clock-cycle time-dependent characteristics. See Footnotes to AC Characteristics.
†Units in nanoseconds (ns).

Parameter Test Status:

- a Tested
- b Guaranteed
- c Guaranteed by Characterization/Design
- d Calculated Parameter—Not Directly Tested

AC CHARACTERISTICS† (Continued)

T-49-17-07

Number	Symbol	Parameter	Z8001/2 4 MHz		Z8001/2 6 MHz		Z8001/2 10 MHz	
			Min	Max	Min	Max	Min	Max
36	TdA(DSR)	Address Valid to \overline{DS} (Read) ↓ Delay	180 ^{d*}		110 ^{d*}		65 ^{d*}	
37	TdC(DSR)	Clock ↑ to \overline{DS} (Read) ↓ Delay		120 ^a		85 ^a		60 ^a
38	TwDSR	\overline{DS} (Read) Width (Low)	275 ^{d*}		185 ^{d*}		110 ^{d*}	
39	TdC(DSW)	Clock ↓ to \overline{DS} (Write) ↓ Delay		95 ^a		80 ^a		60 ^a
40	TwDSW	\overline{DS} (Write) Width (Low)	185 ^{d*}		110 ^{d*}		75 ^{d*}	
41	TdDSI(DR)	\overline{DS} (I/O) ↓ to Read Data Required Valid		330 ^{d*}		210 ^{d*}		120 ^{d*}
42	TdC(DSI)	Clock ↓ to \overline{DS} (I/O) ↓ Delay		120 ^a		90 ^a		60 ^a
43	TwDS	\overline{DS} (I/O) Width (Low)	410 ^{d*}		255 ^{d*}		160 ^{d*}	
44	TdAS(DSA)	\overline{AS} ↑ to \overline{DS} (Acknowledge) ↓ Delay	1065 ^{d*}		690 ^{d*}		410 ^{d*}	
45	TdC(DSA)	Clock ↑ to \overline{DS} (Acknowledge) ↓ Delay		120 ^a		85 ^a		65 ^a
46	TdDSA(DR)	\overline{DS} (Acknowledge) ↓ to Read Data Required Delay		455 ^{d*}		295 ^{d*}		165 ^{d*}
47	TdC(S)	Clock ↑ to Status Valid Delay		110 ^a		85 ^a		65 ^a
48	TdS(AS)	Status Valid to \overline{AS} ↑ Delay	50 ^{d*}		30 ^{d*}		20 ^{d*}	
49	TsR(C)	\overline{RESET} to Clock ↑ Setup Time	180 ^a		70 ^a		50 ^a	
50	ThR(C)	\overline{RESET} to Clock ↑ Hold Time	0 ^a		0 ^a		0 ^a	
51	TwNMI	NMI Width (Low)	100 ^a		70 ^a		50 ^a	
52	TsNMI(C)	NMI to Clock ↑ Setup Time	140 ^a		70 ^a		50 ^a	
53	TsVI(C)	\overline{VI} , \overline{NVI} to Clock ↑ Setup Time	110 ^a		50 ^a		40 ^a	
54	ThVI(C)	\overline{VI} , \overline{NVI} to Clock ↑ Hold Time	20 ^a		20 ^a		10 ^a	
55	TsSGT(C)	\overline{SEGT} to Clock ↑ Setup Time (8001 only)	70 ^a		55 ^a		40 ^a	
56	ThSGT(C)	\overline{SEGT} to Clock ↑ Hold Time (8001 only)	0 ^a		0 ^a		0 ^a	
57	TsMI(C)	\overline{MI} to Clock ↑ Setup Time	180 ^a		140 ^a		80 ^a	
58	ThMI(C)	\overline{MI} to Clock ↑ Hold Time	0 ^a		0 ^a		0 ^a	
59	TdC(MO)	Clock ↑ to \overline{MO} Delay		120 ^a		85 ^a		65 ^a
60	TsSTP(C)	\overline{STOP} to Clock ↓ Setup Time	140 ^a		100 ^a		50 ^a	
61	ThSTP(C)	\overline{STOP} to Clock ↓ Hold Time	0 ^a		0 ^a		0 ^a	
62	TsW(C)	\overline{WAIT} to Clock ↓ Setup Time	50 ^a		30 ^a		20 ^a	
63	ThW(C)	\overline{WAIT} to Clock ↓ Hold Time	10 ^a		10 ^a		5 ^a	
64	TsBRQ(C)	\overline{BUSREQ} to Clock ↑ Setup Time	90 ^a		80 ^a		60 ^a	
65	ThBRQ(C)	\overline{BUSREQ} to Clock ↑ Hold Time	10 ^a		10 ^a		5 ^a	
66	TdC(BAKr)	Clock ↑ to \overline{BUSACK} ↑ Delay		100 ^a		75 ^a		60 ^a
67	TdC(BAKf)	Clock ↑ to \overline{BUSACK} ↓ Delay		100 ^a		75 ^a		60 ^a
68	TwA	Address Valid Width	150 ^{d*}		95 ^{d*}		50 ^{d*}	
69	TdDS(S)	\overline{DS} ↑ to STATUS Not Valid	80 ^{d*}		55 ^{d*}		30 ^{d*}	

*Clock-cycle time-dependent characteristics. See Footnotes to AC Characteristics.

†Units in nanoseconds (ns).

Parameter Test Status:

- a Tested
- b Guaranteed
- c Guaranteed by Characterization/Design
- d Calculated Parameter—Not Directly Tested

FOOTNOTES TO AC CHARACTERISTICS

T-49-17-07

Number	Symbol	Z8001/2 4 MHz Equation	Z8001/2 6 MHz Equation	Z8001/2 10 MHz Equation
11	TdA(DR)	$2TcC + TwCh - 130 \text{ ns}$	$2TcC + TwCh - 95 \text{ ns}$	$2TcC + TwCh - 60 \text{ ns}$
13	TdDS(A)	$TwCl - 25 \text{ ns}$	$TwCl - 25 \text{ ns}$	$TwCl - 20 \text{ ns}$
16	TdDW(DS)	$TcC + TwCh - 60 \text{ ns}$	$TcC + TwCh - 40 \text{ ns}$	$TcC + TwCh - 30 \text{ ns}$
17	TdA(MR)	$TwCh - 50 \text{ ns}$	$TwCh - 35 \text{ ns}$	$TwCh - 20 \text{ ns}$
19	TwMRh	$TcC - 40 \text{ ns}$	$TcC - 30 \text{ ns}$	$TcC - 20 \text{ ns}$
20	TdMR(A)	$TwCl - 35 \text{ ns}$	$TwCl - 35 \text{ ns}$	$TwCl - 20 \text{ ns}$
21	TdDW(DSW)	$TwCh - 50 \text{ ns}$	$TwCh - 35 \text{ ns}$	$TwCh - 25 \text{ ns}$
22	TdMR(DR)	$2TcC - 130 \text{ ns}$	$2TcC - 100 \text{ ns}$	$2TcC - 60 \text{ ns}$
25	TdA(AS)	$TwCh - 50 \text{ ns}$	$TwCh - 35 \text{ ns}$	$TwCh - 20 \text{ ns}$
27	TdAS(DR)	$2TcC - 140 \text{ ns}$	$2TcC - 110 \text{ ns}$	$2TcC - 60 \text{ ns}$
28	TdDS(AS)	$TwCl - 35 \text{ ns}$	$TwCl - 35 \text{ ns}$	$TwCl - 25 \text{ ns}$
29	TwAS	$TwCh - 20 \text{ ns}$	$TwCh - 15 \text{ ns}$	$TwCh - 10 \text{ ns}$
30	TdAS(A)	$TwCl - 35 \text{ ns}$	$TwCl - 25 \text{ ns}$	$TwCl - 20 \text{ ns}$
32	TdAS(DSR)	$TwCl - 25 \text{ ns}$	$TwCl - 15 \text{ ns}$	$TwCl - 10 \text{ ns}$
33	TdDSR(DR)	$TcC + TwCh - 150 \text{ ns}$	$TcC + TwCh - 105 \text{ ns}$	$TcC + TwCh - 70 \text{ ns}$
35	TdDS(DW)	$TwCl - 30 \text{ ns}$	$TwCl - 25 \text{ ns}$	$TwCl - 15 \text{ ns}$
36	TdA(DSR)	$TcC - 70 \text{ ns}$	$TcC - 55 \text{ ns}$	$TcC - 35 \text{ ns}$
38	TwDSR	$TcC + TwCh - 80 \text{ ns}$	$TcC + TwCh - 50 \text{ ns}$	$TcC + TwCh - 30 \text{ ns}$
40	TwDSW	$TcC - 65 \text{ ns}$	$TcC - 55 \text{ ns}$	$TcC - 25 \text{ ns}$
41	TdDSI(DR)	$2TcC - 170 \text{ ns}$	$2TcC - 120 \text{ ns}$	$2TcC - 80 \text{ ns}$
43	TwDS	$2TcC - 90 \text{ ns}$	$2TcC - 75 \text{ ns}$	$2TcC - 40 \text{ ns}$
44	TdAS(DSA)	$4TcC + TwCl - 40 \text{ ns}$	$4TcC + TwCl - 40 \text{ ns}$	$4TcC + TwCl - 30 \text{ ns}$
46	TdDSA(DR)	$2TcC + TwCh - 150 \text{ ns}$	$2TcC + TwCh - 105 \text{ ns}$	$2TcC + TwCh - 75 \text{ ns}$
48	TdS(AS)	$TwCh - 55 \text{ ns}$	$TwCh - 40 \text{ ns}$	$TwCh - 20 \text{ ns}$
68	TwA	$TcC - 90 \text{ ns}$	$TcC - 70 \text{ ns}$	$TcC - 50 \text{ ns}$
69	TdDS(s)	$TwCl - 25 \text{ ns}$	$TwCl - 15 \text{ ns}$	$TwCl - 10 \text{ ns}$

AC Timing Test Conditions

$V_{OL} = 0.8V$
 $V_{OH} = 2.0V$
 $V_{IL} = 0.8V$
 $V_{IH} = 2.4V$
 $V_{ILC} = 0.45V$
 $V_{IHC} = V_{CC} - 0.4V$

PIN DESCRIPTION

T-49-17-07

AD₀-AD₁₅. Address/Data (inputs/outputs, active High, 3-state). These multiplexed address and data lines are used for I/O and to address memory.

AS. Address Strobe (output, active Low, 3-state). The rising edge of AS indicates addresses are valid.

BUSACK. Bus Acknowledge (output active Low). A Low on this line indicates the CPU has relinquished control of the bus.

BUSREQ. Bus Request (input, active Low). This line must be driven Low to request the bus from the CPU.

B/W. Byte/Word (output, Low = Word, 3-state). This signal defines the type of memory reference on the 16-bit address/data bus.

CLK. System Clock (input). CLK is a 5V single-phase time-base input.

DS. Data Strobe (output, active Low, 3-state). This line times the data in and out of the CPU.

MREQ. Memory Request (output, active Low, 3-state). A Low on this line indicates that the address/data bus holds a memory address.

MI, MO. Multi-Micro In, Multi-Micro Out (input and output, active Low). These two lines form a resource-request daisy chain that allows one CPU in a multi-microprocessor system to access a shared resource.

NMI. Non-Maskable Interrupt (edge triggered, input, active Low). A high-to-low transition on NMI requests a non-maskable interrupt. The NMI interrupt has the highest priority of the three types of interrupts.

N/S. Normal/System Mode (output, Low = System Mode, 3-state). N/S indicates the CPU is in the normal or system mode.

NVI. Non-Vectored Interrupt (input, active Low). A Low on this line requests a non-vectored interrupt.

RESET. Reset (input, active Low). A Low on this line resets the CPU.

R/W. Read/Write (output, Low = Write, 3-state). R/W indicates that the CPU is reading from or writing to memory or I/O.

SEGT. Segment Trap (input, active Low). The Memory Management Unit interrupts the CPU with a Low on this line when the MMU detects a segmentation trap. Input on Z8001 only.

SN₀-SN₆. Segment Number (outputs, active High, 3-state). These lines provide the 7-bit segment number used to address one of 128 segments by the Z8010 memory Management Unit. Output by the Z8001 only.

ST₀-ST₃. Status (outputs, active High, 3-state). These lines specify the CPU status.

STOP. Stop (input, active Low). This input can be used to single-step instruction execution.

VI. Vectored Interrupt (input, active Low). A Low on this line requests a vectored interrupt.

WAIT. Wait (input, active Low). This line indicates to the CPU that the memory or I/O device is not ready for data transfer.

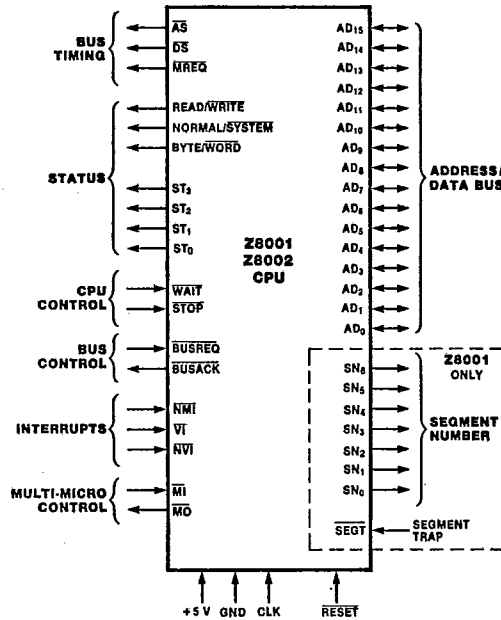

Figure 9. Z8000 CPU Pin Functions

PACKAGE PINOUTS

T-49-17-07

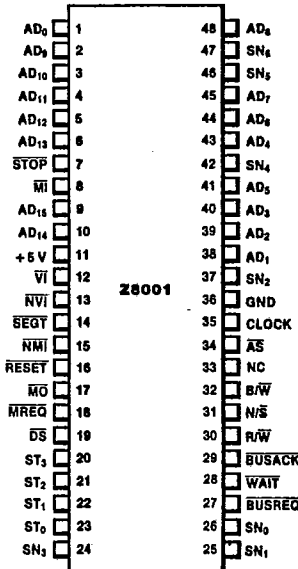

Figure 10a. 48-pin Dual-In-Line Package (DIP), Pin Assignments

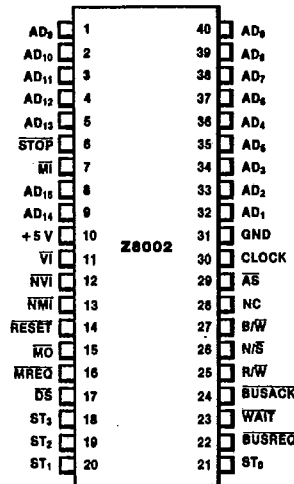
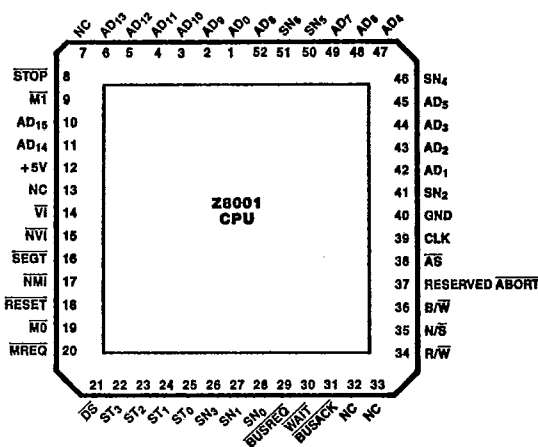

Figure 11a. 40-pin Dual-In-Line Package (DIP), Pin Assignments



NC = No connection

Figure 10b. 52-pin Chip Carrier, Pin Assignments

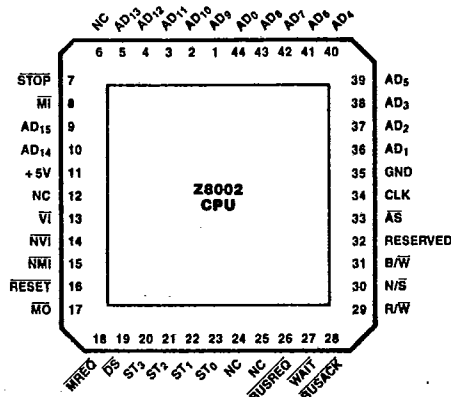

Figure 11b. 44-pin Chip Carrier, Pin Assignments

MIL-STD-883 MILITARY PROCESSED PRODUCT

T-49-17-07

- Mil-Std-883 establishes uniform methods and procedures for testing microelectronic devices to insure the electrical, mechanical, and environmental integrity and reliability that is required for military applications.
- Mil-Std-883 Class B is the industry standard product assurance level for military ground and aircraft application.
- Compliant to 883 Class B, Revision C process requirements.
- The total reliability of a system depends upon tests that are designed to stress specific quality and reliability concerns that affect microelectronic products.
- The following tables detail the 100% screening and electrical tests, sample electrical tests, and Qualification/Quality Conformance testing required.

Zilog Military Product Flow

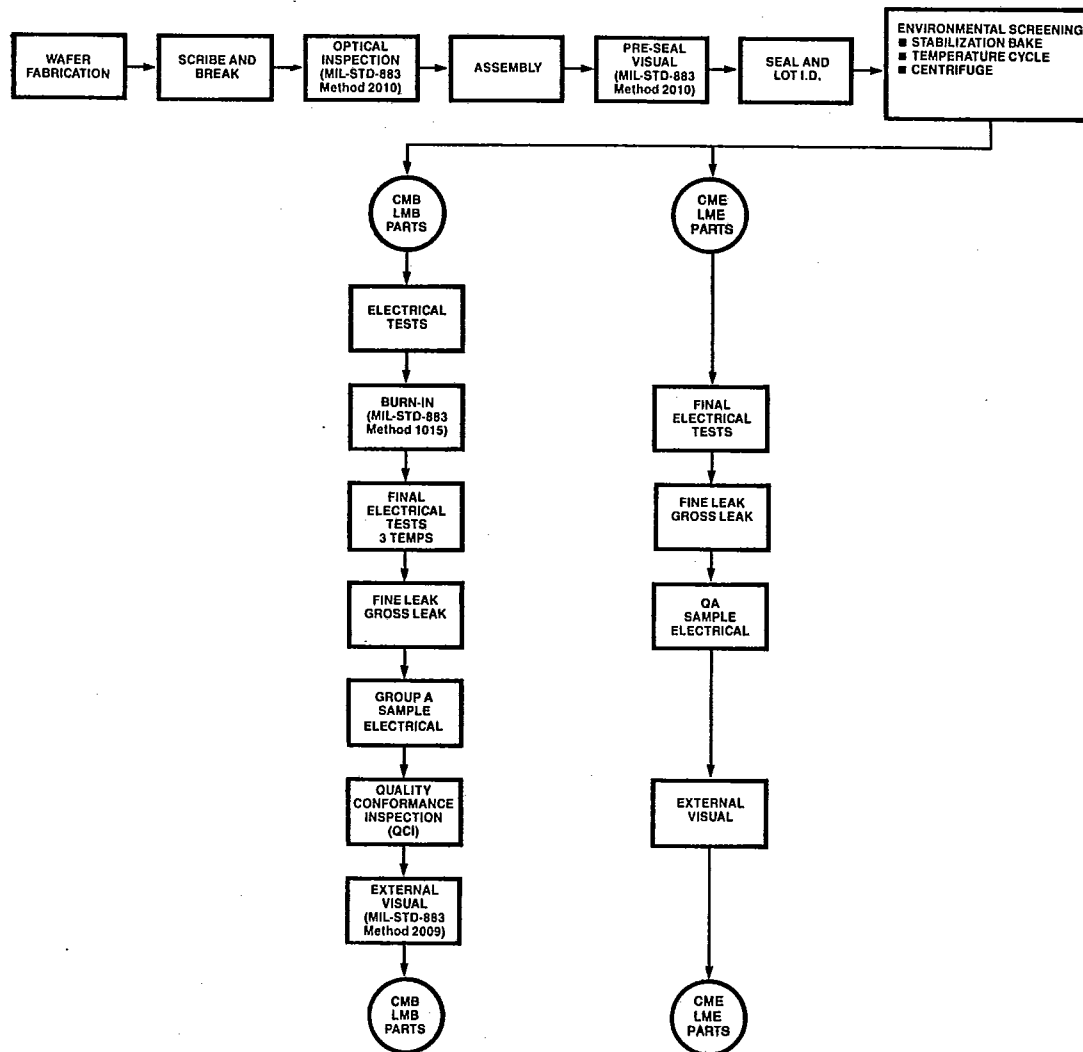

Table I
MIL-STD-883 Class B Screening Requirements
Method 5004 (Note 4)

T-49-17-07

Test	Mil-Std-883 Method	Test Condition	Requirement
Internal Visual	2010	Condition B	100%
Stabilization Bake	1008	Condition C	100%
Temperature Cycle	1010	Condition C	100%
Constant Acceleration (Centrifuge)	2001	Condition E or D ^(Note 1) , Y ₁ Axis Only	100%
Initial Electrical Tests		Zilog Military Electrical Specification Static/DC T _C = +25°C	100%
Burn-In	1015	Condition D ^(Note 2) , 160 hours, T _A = +125°C	100%
Interim Electrical Tests		Zilog Military Electrical Specification Static/DC T _C = +25°C	100%
PDA Calculation		PDA = 5%	100%
Final Electrical Tests		Zilog Military Electrical Specification Static/DC T _C = +125°C, -55°C Functional, Switching/AC T _C = +25°C	100%
Fine Leak	1014	Condition B ₁	100%
Gross Leak	1014	Condition C	100%
Quality Conformance Inspection (QCI)			
Group A	Each Inspection Lot	5005 (See Table II)	Sample
Group B	Every Week	5005 (See Table III)	Sample
Group C	Periodically ^(Note 3)	5005 (See Table IV)	Sample
Group D	Periodically ^(Note 3)	5005 (See Table V)	Sample
External Visual	2009		100%
QA—Ship			100%

NOTES:

1. Applies to larger packages which have an inner seal or cavity perimeter of two inches or more in total length or have a package mass of ≥5 grams.
2. In process of fully implementing of Condition D Burn-In Circuits. Contact factory for copy of specific burn-in circuit available.
3. Performed periodically as required by Mil-Std-883, paragraph 1.2.1 b(17).
4. Processing fully compliant to Mil-Std-883 Revision C requirements.

Table II Group A
Sample Electrical Tests
MIL-STD-883 Method 5005

T-49-17-07

Subgroup	Tests	Temperature (T _C)	Sample Size
Subgroup 1	Static/DC	+25°C	100%
Subgroup 2	Static/DC	+125°C	116/0
Subgroup 3	Static/DC	-55°C	116/0
Subgroup 7	Functional	+25°C	100%
Subgroup 8	Functional	-55°C and +125°C	116/0
Subgroup 9	Switching/AC	+25°C	100%
Subgroup 10	Switching/AC	+125°C	116/0
Subgroup 11	Switching/AC	-55°C	116/0

NOTES:

- The specific parameters to be included for tests in each subgroup shall be as specified in the applicable detail electrical specification. Where no parameters have been identified in a particular subgroup or test within a subgroup, no Group A testing is required for that subgroup or test.
- Group A testing by subgroup or within subgroups may be performed in any sequence unless otherwise specified.
- If any failure occurs during sample testing of any subgroup then the lot is 100% tested at the failed subgroup only.

Table III Group B

T-49-17-07

Sample Test Performed Every Week to
Test Construction and Insure Integrity of Assembly Process.
MIL-STD-883 Method 5005

Subgroup	Mil-Std-883 Method	Test Condition	Quantity or LTPD/Max Accept
Subgroup 2 Resistance to Solvents	2015		4/0
Subgroup 3 Solderability	2003	Solder Temperature +245°C ± 5°C	15(Note 1)
Subgroup 5 Bond Strength	2011	C	15(Note 2)

NOTES:

1. Number of leads inspected selected from a minimum of 3 devices.
2. Number of bond pulls selected from a minimum of 4 devices.

Table IV Group C

T-49-17-07

**Sample Test Performed Periodically to Verify Integrity of the Die.
MIL-STD-883 Method 5005**

Subgroup	Mil-Std-883 Method	Test Condition	Quantity or LTPD/Max Accept
Subgroup 1			
Steady State Operating Life	1005	Condition D ^(Note 1) , 1000 hours at +125°C	5
End Point Electrical Tests		Zilog Military Electrical Specification T _C = +25°C, +125°C, -55°C	

NOTE:

1. In process of fully implementing Condition D Burn-In Circuits. Contact factory for copy of specific burn-in circuit available.

Table V Group D

T-49-17-07

Sample Test Performed Periodically to Insure Integrity of the Package.
MIL-STD-883 Method 5005

Subgroup	MIL-Std-883 Method	Test Condition	Quantity or LTPD/Max Accept
Subgroup 1			
Physical Dimensions	2016		15
Subgroup 2			
Lead Integrity	2004	Condition B ₂ or D ^(Note 1)	15
Subgroup 3			
Thermal Shock	1011	Condition B minimum, 15 cycles minimum	
Temperature Cycling	1010	Condition C, 100 cycles minimum	15
Moisture Resistance	1004		
Seal	1014		
3a) Fine Leak		3a) Condition B	
3b) Gross Leak		3b) Condition C	
Visual Examination	1004 or 1010		
End Point Electrical Tests		Zilog Military Electrical Specification T _C = +25°C, +125°C, -55°C	
Subgroup 4			
Mechanical Shock	2002	Condition B minimum	
Vibration Variable Frequency	2007	Condition A minimum	
Constant Acceleration (Centrifuge)	2001	Condition E or D ^(Note 2) , Y ₁ Axis Only	15
Seal	1014		
4a) Fine Leak		4a) Condition B	
4b) Gross Leak		4b) Condition C	
Visual Examination	1010 or 1011		
End Point Electrical Tests		Zilog Military Electrical Specification T _C = +25°C, +125°C, -55°C	
Subgroup 5			
Salt Atmosphere	1009	Condition A minimum	
Seal	1014		15
5a) Fine Leak		5a) Condition B	
5b) Gross Leak		5b) Condition C	
Visual Examination	1009		
Subgroup 6			
Internal Water Vapor Content	1018	5,000 ppm. maximum water content at +100°C	3/0 or 5/1
Subgroup 7 ^(Note 3)			
Adhesion of Lead Finish	2025		15 ^(Note 4)
Subgroup 8 ^(Note 5)			
Lid Torque	2024		5/0

NOTES:

1. Lead Integrity Condition D for leadless chip carriers.
2. Applies to larger packages which have an inner seal or cavity perimeter of two inches or more in total length or have a package mass of ≥5 grams.
3. Not applicable to leadless chip carriers.
4. LTPD based on number of leads.
5. Not applicable for solder seal packages.

PACKAGE INFORMATION

T-49-17-07

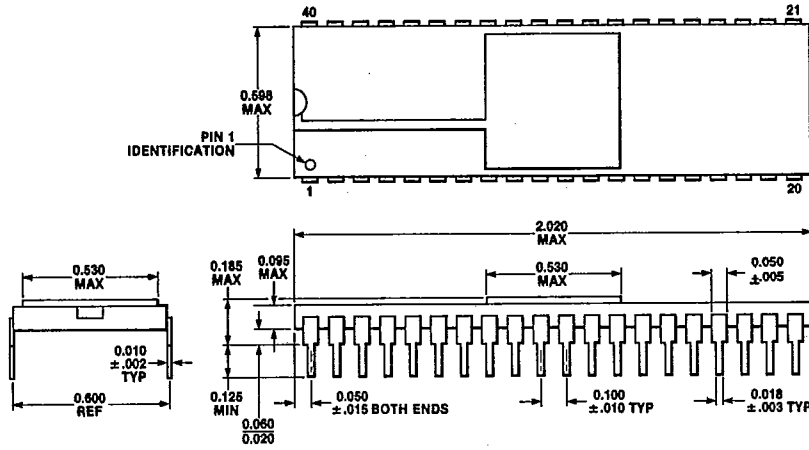

40-Pin Dual-in-Line Package (DIP),
Ceramic

PACKAGE INFORMATION (Continued)

T-49-17-07

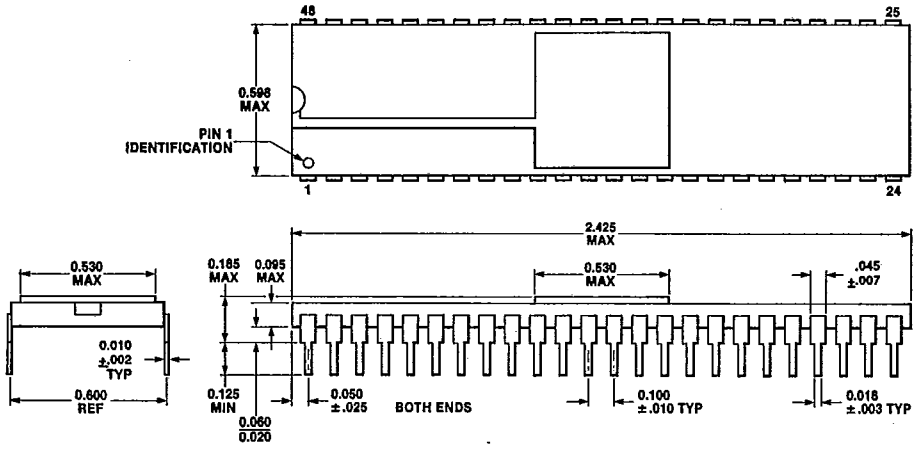

48-Pin Dual-in-Line Package (DIP),
Ceramic

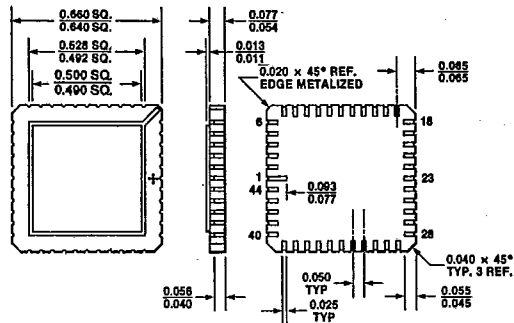

44-Pin Leadless Chip Carrier (LCC),
Ceramic, JEDEC Type C

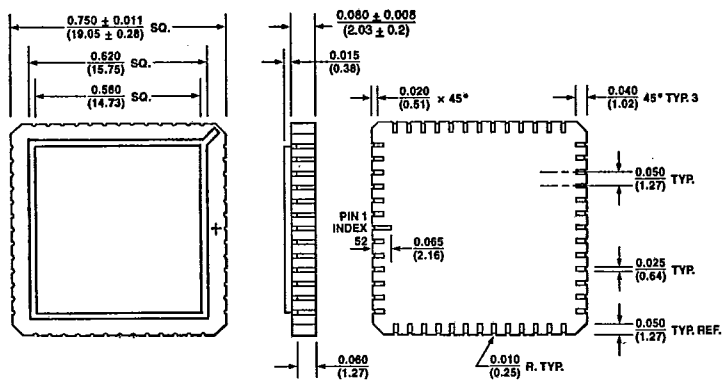

52-Pin Leadless Chip Carrier (LCC),
Ceramic, JEDEC Type C

ORDERING INFORMATION

T-49-17-07

Z8001 Segmented CPU, 4.0 MHz
 48-pin DIP 52-pin LCC
 Z0800104CMB Z0800104LMB

Z8001 Segmented CPU, 6.0 MHz
 48-pin DIP 52-pin LCC
 Z0800106CME Z0800106LME
 Z0800106CMB Z0800106LMB

Z8001 Segmented CPU, 10.0 MHz
 48-pin DIP 52-pin LCC
 Z0800110CME Z0800110LME
 Z0800110CMB Z0800110LMB

Z8002 Non-Segmented CPU, 4.0 MHz
 40-pin DIP 44-pin LCC
 Z0800204CMB Z0800204LMB
 Z0800204CMJ*

Z8002 Non-Segmented CPU, 6.0 MHz
 40-pin DIP 44-pin LCC
 Z0800206CME Z0800206LME
 Z0800206CMB Z0800206LMB
 Z0800206CMJ*

Z8002 Non-Segmented CPU, 10.0 MHz
 40-pin DIP 44-pin LCC
 Z0800210CME Z0800210LME
 Z0800210CMB Z0800210LMB

Codes

PACKAGE

C = Ceramic
 L = Ceramic LCC

TEMPERATURE

M = -55°C to +125°C

ENVIRONMENTAL

E = Hermetic Standard
 B = 833 Class B Military
 J = JAN 38510 Military

Example:
 Z0800104CMB is an 8001, 4 MHz, Ceramic DIP, -55°C to +125°C, 883 Class B Military Flow (Revision C Compliant).

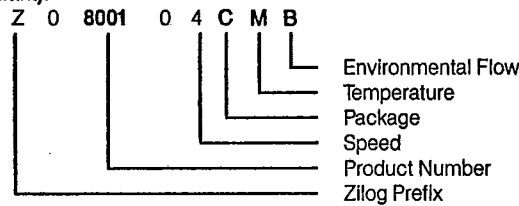

*See MIL-M-38510 Slash Sheet 520 for flow and electrical specifications for Z8002 (4 and 6 MHz).