

PNP LOW DROPOUT REGULATOR TRANSISTOR

ZBD949

ISSUE 3 – NOVEMBER 1994

FEATURES

- * Guaranteed h_{FE} specified up to 5 Amps
- * Low collector-emitter saturation voltage
 - 0.11V Maximum at 1A
 - 0.45V Maximum at 5A

The high gain and very low saturation voltage produce a more effective solution than monolithic options

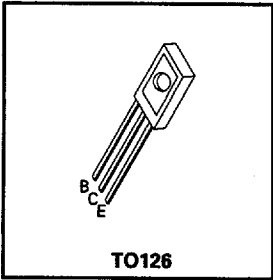

ABSOLUTE MAXIMUM RATINGS.

PARAMETER	SYMBOL	VALUE	UNIT
Collector-Base Voltage	V_{CBO}	-50	V
Collector-Emitter Voltage	V_{CEO}	-30	V
Emitter-Base Voltage	V_{EBO}	-6	V
Peak Pulse Current	I_{CM}	-20	A
Continuous Collector Current	I_C	-5	A
Power Dissipation at $T_{amb}=25^{\circ}C$	P_{tot}	2	W
Power Dissipation at $T_{case}=25^{\circ}C$	P_{tot}	25	W
Operating and Storage Temperature Range	T_j, T_{stg}	-55 to +200	$^{\circ}C$

TYPICAL APPLICATION

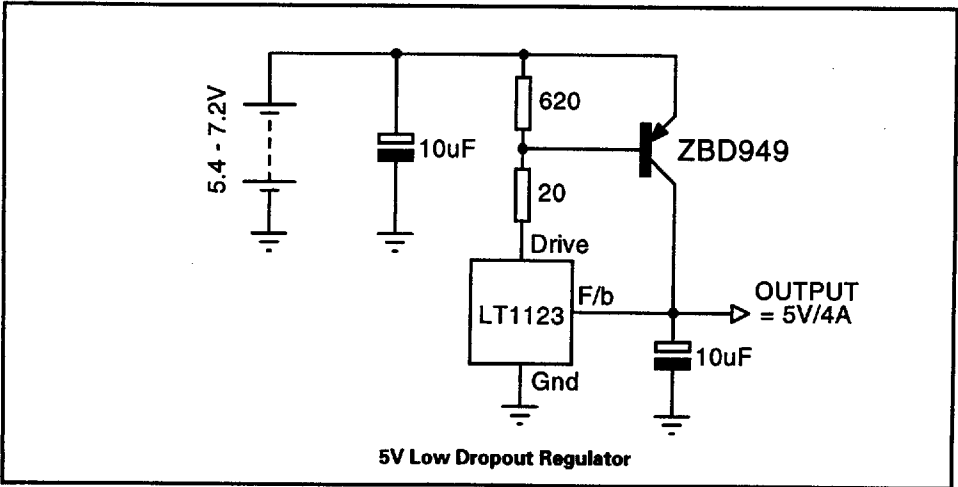

ZBD949

ELECTRICAL CHARACTERISTICS (at $T_{amb} = 25^{\circ}\text{C}$ unless otherwise stated)

PARAMETER	SYMBOL	MIN.	TYP.	MAX.	UNIT	CONDITIONS.
Collector-Base Breakdown Voltage	$V_{(BR)CBO}$	-50	-80		V	$I_C = -100\mu\text{A}$
Collector-Emitter Breakdown Voltage	$V_{(BR)CER}$	-50	-80		V	$I_C = -1\mu\text{A}$, $R_B \leq 1\text{K}\Omega$
Collector-Emitter Breakdown Voltage	$V_{(BR)CEO}$	-30	-45		V	$I_C = -10\text{mA}$
Emitter-Base Breakdown Voltage	$V_{(BR)EBO}$	-6	-8		V	$I_E = -100\mu\text{A}$
Collector Cut-Off Current	I_{CBO}			-50 -1	nA μA	$V_{CB} = -40\text{V}$ $V_{CB} = -40\text{V}$, $T_{amb} = 100^{\circ}\text{C}$
Collector Cut-Off Current	I_{CER} $R \leq 1\text{K}\Omega$			-50 -1	nA μA	$V_{CB} = -40\text{V}$ $V_{CB} = -40\text{V}$, $T_{amb} = 100^{\circ}\text{C}$
Emitter Cut-Off Current	I_{EBO}			-10	nA	$V_{EB} = -6\text{V}$
Collector-Emitter Saturation Voltage	$V_{CE(sat)}$			-60 -110 -170 -450	mV mV mV mV	$I_C = -0.5\text{A}$, $I_B = -20\text{mA}^*$ $I_C = -1\text{A}$, $I_B = -20\text{mA}^*$ $I_C = -2\text{A}$, $I_B = -200\text{mA}^*$ $I_C = -5\text{A}$, $I_B = -300\text{mA}^*$
Base-Emitter Saturation Voltage	$V_{BE(sat)}$		-1000	-1150	mV	$I_C = -5\text{A}$, $I_B = -300\text{mA}^*$
Base-Emitter Turn-On Voltage	$V_{BE(on)}$		-950	-1100	mV	$I_C = -5\text{A}$, $V_{CE} = -1\text{V}^*$
Static Forward Current Transfer Ratio	h_{FE}	100 100 75	200 200 140 35	350 300 300		$I_C = -10\text{mA}$, $V_{CE} = -1\text{V}^*$ $I_C = -1\text{A}$, $V_{CE} = -1\text{V}^*$ $I_C = -5\text{A}$, $V_{CE} = -1\text{V}^*$ $I_C = -20\text{A}$, $V_{CE} = -1\text{V}^*$
Transition Frequency	f_T		100		MHz	$I_C = -100\text{mA}$, $V_{CE} = -10\text{V}$ $f = 50\text{MHz}$

*Measured under pulsed conditions. Pulse width=300 μs . Duty cycle $\leq 2\%$

ZBD949

TYPICAL CHARACTERISTICS

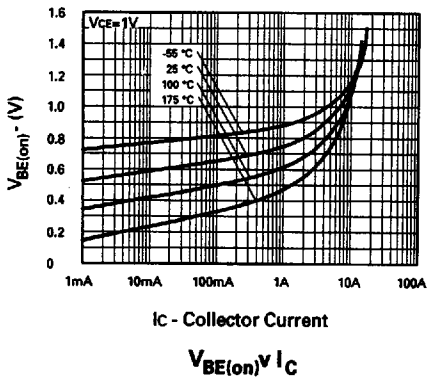
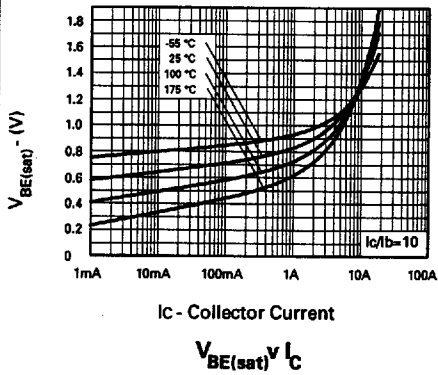
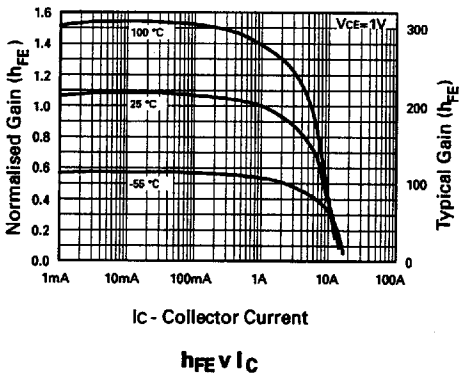
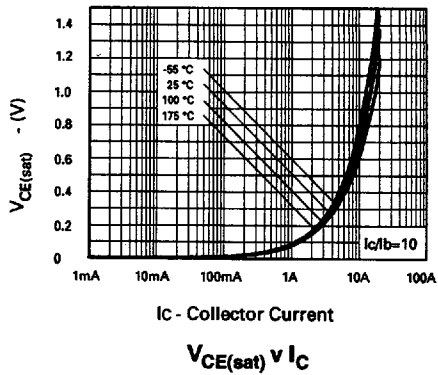
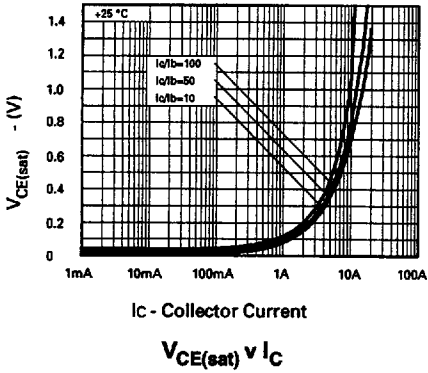

TYPICAL CHARACTERISTICS

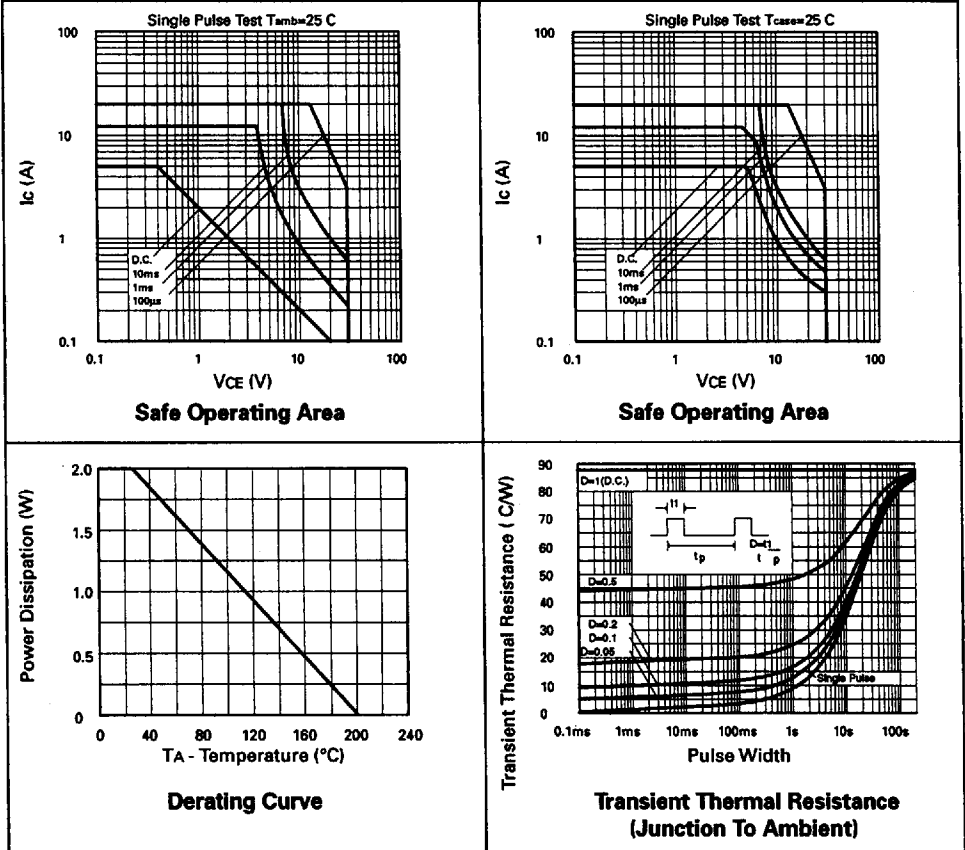

THERMAL CHARACTERISTICS

PARAMETER	SYMBOL	MAX	UNIT
Thermal resistance Junction to ambient	$R_{th(j-amb)}$	87.5	$^{\circ}\text{C/W}$
Junction to case	$R_{th(j-case)}$	7	$^{\circ}\text{C/W}$

E-Line Package Dimensions

3 Pin Device

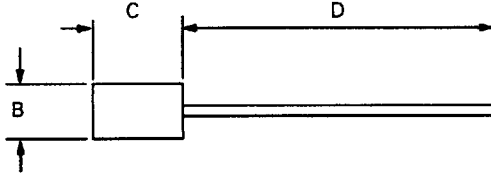

DIM	Millimeters		Inches	
	Min	Max	Min	Max
A	4.37	4.77	0.172	0.188
B	2.16	2.41	0.085	0.095
C	3.61	4.01	0.142	0.158
D	13.00	13.97	0.512	0.550
E	NOM 1.27		NOM 0.05	
F	0.37	0.495	0.016	0.0195

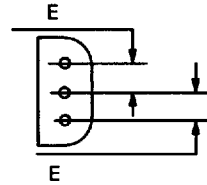
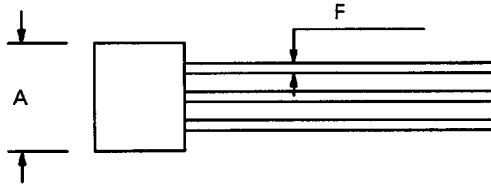

Leads to pass through a hole 0.7mm dia.

Various lead forms are offered, details of which are available on request.

2 Pin Device

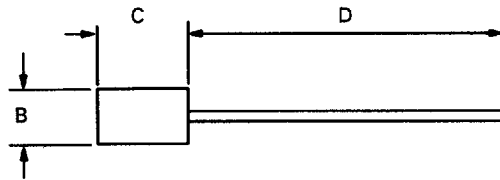

DIM	Millimeters		Inches	
	Min	Max	Min	Max
A	4.37	4.77	0.172	0.188
B	2.16	2.41	0.085	0.095
C	3.61	4.01	0.142	0.158
D	13.00	13.97	0.512	0.550
E	NOM 2.54		NOM 0.10	
F	0.37	0.495	0.016	0.0195

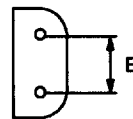
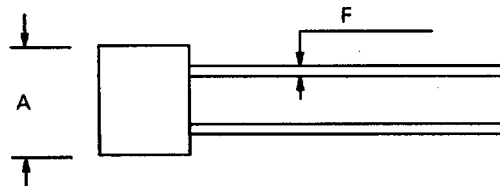

Leads to pass through a hole 0.7mm dia.

T092 Package Dimensions

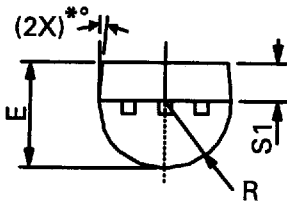
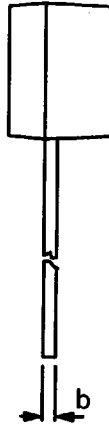
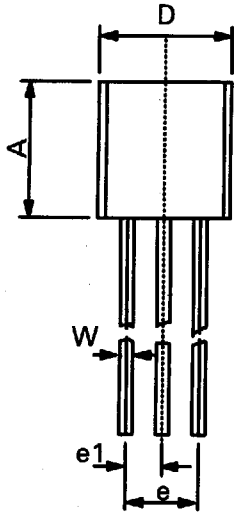

DIM	Millimeters		Inches	
	Min	Max	Min	Max
A	4.32	4.95	0.170	0.195
b	0.36	0.51	0.014	0.020
E	3.30	3.94	0.130	0.155
e	2.41	2.67	0.095	0.105
e1	1.14	1.40	0.045	0.055
L	12.70	15.49	0.500	0.610
R	2.16	2.41	0.085	0.095
S1	1.14	1.52	0.045	0.060
W	0.41	0.56	0.016	0.022
D	4.45	4.95	0.175	0.195
*°	4°	6°	4°	6°

TO126 Package Dimensions

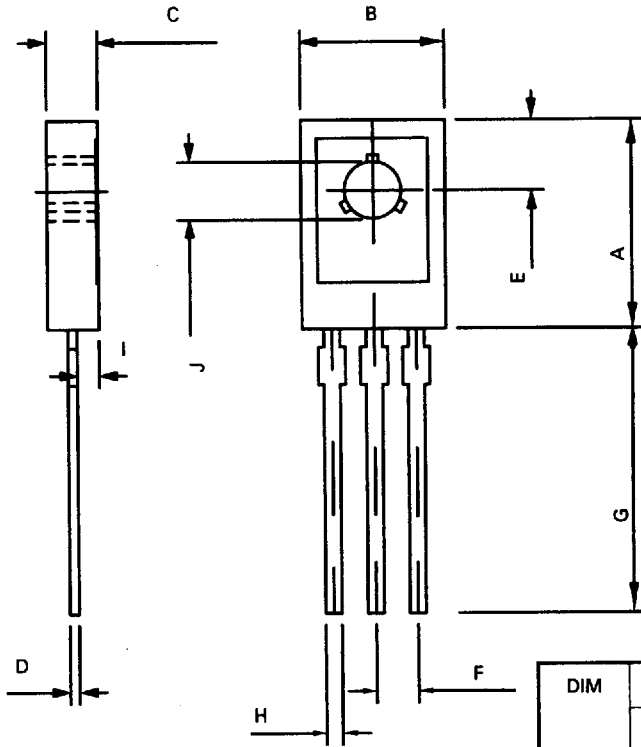

DIM	Millimeters	
	Min	Max
A		11.1
B		7.80
C		2.80
D	0.50 typical	
E	3.75 typical	
F	2.29 typical	
G	15.3	
H		0.88
I	1.2 typical	
J	3.00	3.20