



## Zener Diode Series

# ZD52XXBS2

### Description

The ZD52XXBS2 series covers zener voltage range from 2.4V to 33V, and is encapsulated in SOD-323 package, very suitable for low cost, low power voltage regulation application.

### Mechanical Data

- Case: Molded Plastic, JEDEC SOD-323.
- Terminals: Solder plated, solderable per MIL-STD-750 Method 2026
- Polarity: Indicated by cathode band.
- Mounting Position : Any.
- Weight: 0.0045 gram, 0.000159 ounce

### Symbol

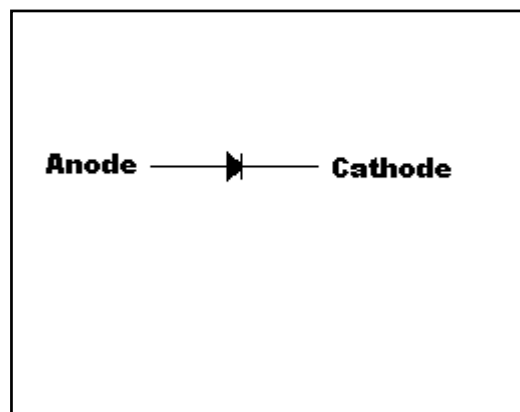

### Outline

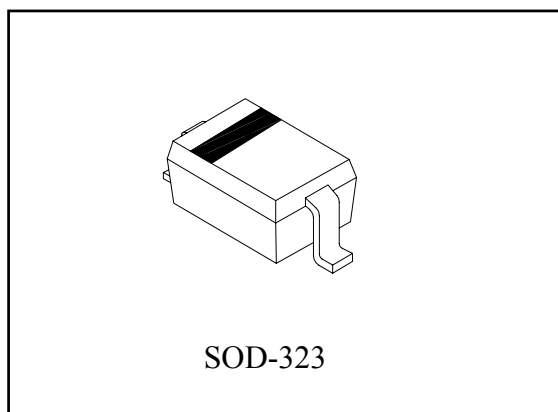

### Absolute Maximum Ratings (Ta=25°C, unless otherwise specified)

- Maximum Temperatures
 

Storage Temperature T <sub>stg</sub> .....	-55~+150 °C
Junction Temperature T <sub>j</sub> .....	+150 °C
- Maximum Power Dissipation
 

Total Power Dissipation P <sub>tot</sub> (Note).....	200 mW
Derate above 25°C .....	1.57mW/°C
- Thermal Resistance, Junction to Ambient Air R<sub>θJA</sub>.....625°C/W

Note : Parts mounted on FR-5 board with minimum pad.

**Electrical Characteristic** ( $V_F=0.9V$  Max @ $I_F=10mA$  for all types.)

Device	Marking Code	Test Current $I_{ZT}(mA)$	Zener Voltage $V_Z(V)$	$Z_{ZK}$ $I_Z=0.25mA$ ( $\Omega, Max$ )	$Z_{ZT}$ $I_Z=I_{ZT}$ ( $\Omega, Max$ )	Max. Reverse Current $I_R(\mu A)$ @ $V_R(V)$	
ZD5221B	21	20	2.4 $\pm 5\%$	1200	30	100	1.0
ZD5222B	22	20	2.5 $\pm 5\%$	1250	30	100	1.0
ZD5223B	23	20	2.7 $\pm 5\%$	1300	30	75	1.0
ZD5225B	25	20	3.0 $\pm 5\%$	1600	29	50	1.0
ZD5226B	26	20	3.3 $\pm 5\%$	1600	28	25	1.0
ZD5227B	27	20	3.6 $\pm 5\%$	1700	24	15	1.0
ZD5228B	28	20	3.9 $\pm 5\%$	1900	23	10	1.0
ZD5229B	29	20	4.3 $\pm 5\%$	2000	22	5.0	1.0
ZD5230B	30	20	4.7 $\pm 5\%$	1900	19	5.0	2.0
ZD5231B	31	20	5.1 $\pm 5\%$	1600	17	5.0	2.0
ZD5232B	32	20	5.6 $\pm 5\%$	1600	11	5.0	3.0
ZD5233B	33	20	6.0 $\pm 5\%$	1600	7.0	5.0	3.5
ZD5234B	34	20	6.2 $\pm 5\%$	1000	7.0	5.0	4.0
ZD5235B	35	20	6.8 $\pm 5\%$	750	5.0	3.0	5.0
ZD5236B	36	20	7.5 $\pm 5\%$	500	6.0	3.0	6.0
ZD5237B	37	20	8.2 $\pm 5\%$	500	8.0	3.0	6.5
ZD5238B	38	20	8.7 $\pm 5\%$	600	8.0	3.0	6.5
ZD5239B	39	20	9.1 $\pm 5\%$	600	10	3.0	7.0
ZD5240B	40	20	10 $\pm 5\%$	600	17	3.0	8.0
ZD5241B	41	20	11 $\pm 5\%$	600	22	2.0	8.4
ZD5242B	42	20	12 $\pm 5\%$	600	30	1.0	9.1
ZD5243B	43	9.5	13 $\pm 5\%$	600	13	0.5	9.9
ZD5244B	44	9.0	14 $\pm 5\%$	600	15	0.1	10
ZD5245B	45	8.5	15 $\pm 5\%$	600	16	0.1	11
ZD5246B	46	7.8	16 $\pm 5\%$	600	17	0.1	12
ZD5247B	47	7.4	17 $\pm 5\%$	600	19	0.1	13
ZD5248B	48	7.0	18 $\pm 5\%$	600	21	0.1	14
ZD5249B	49	6.6	19 $\pm 5\%$	600	23	0.1	14
ZD5250B	50	6.2	20 $\pm 5\%$	600	25	0.1	15
ZD5251B	51	5.6	22 $\pm 5\%$	600	29	0.1	17
ZD5252B	52	5.2	24 $\pm 5\%$	600	33	0.1	18
ZD5253B	53	5.0	25 $\pm 5\%$	600	35	0.1	19
ZD5254B	54	4.6	27 $\pm 5\%$	600	41	0.1	21
ZD5255B	55	4.5	28 $\pm 5\%$	600	44	0.1	21
ZD5256B	56	4.2	30 $\pm 5\%$	600	49	0.1	23
ZD5257B	57	3.8	33 $\pm 5\%$	700	58	0.1	25



### Characteristic Curves

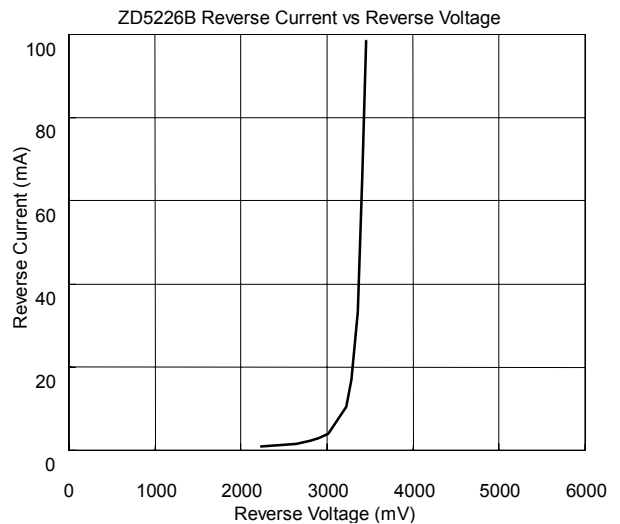
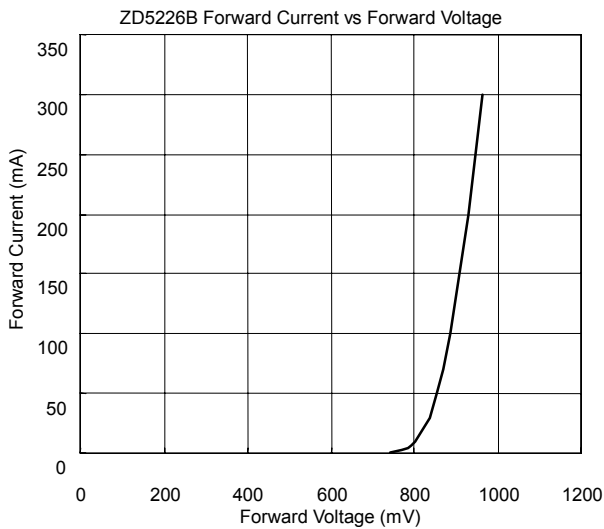
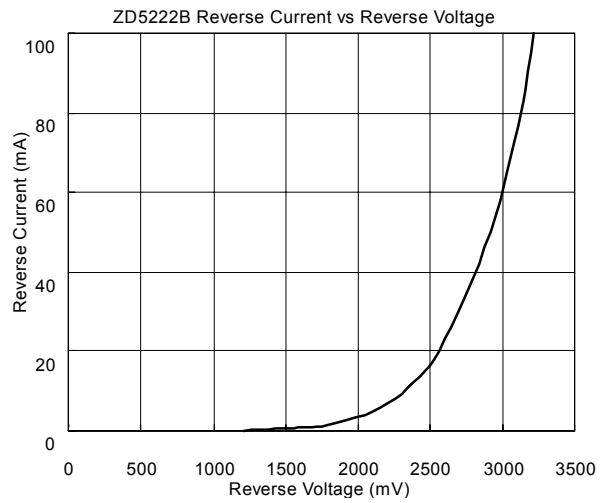
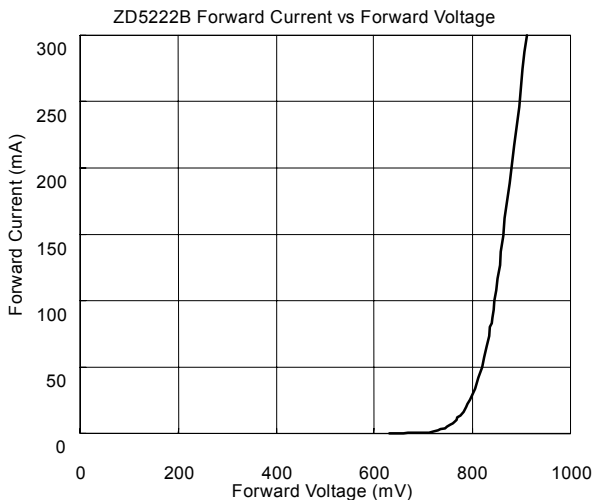
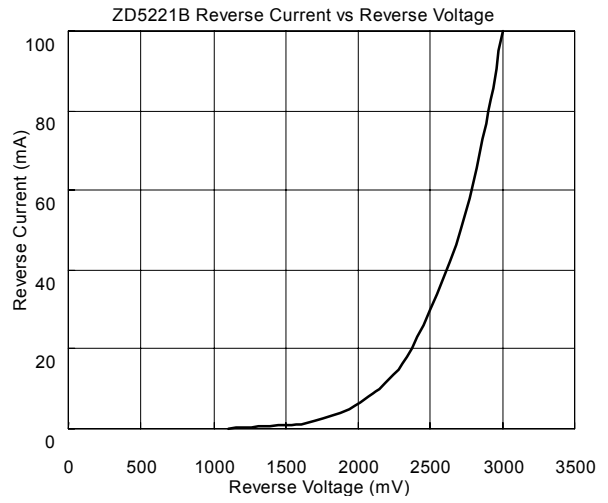
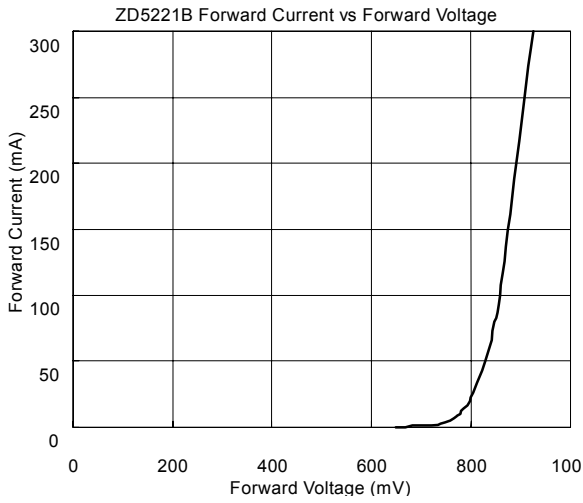



ZD5228B Forward Current vs Forward Voltage

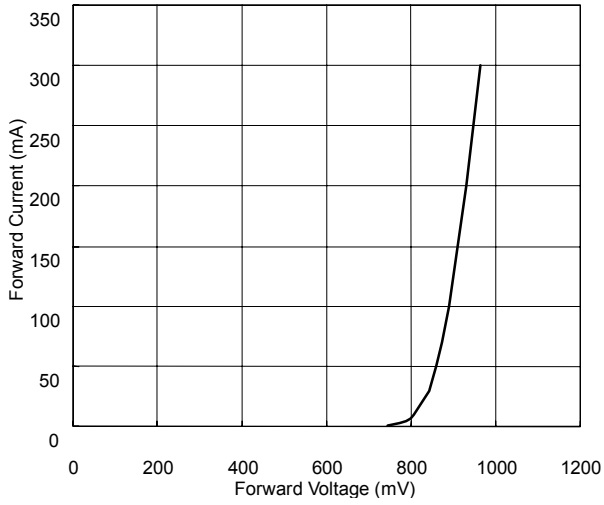

ZD5228B Reverse Current vs Reverse Voltage

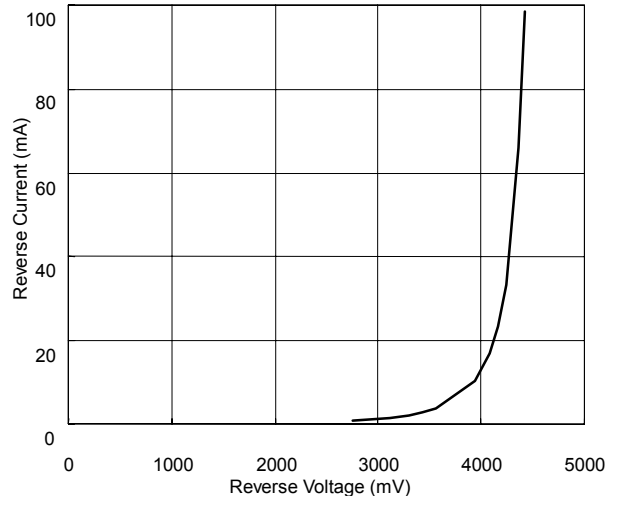

ZD5229B Forward Current vs Forward Voltage

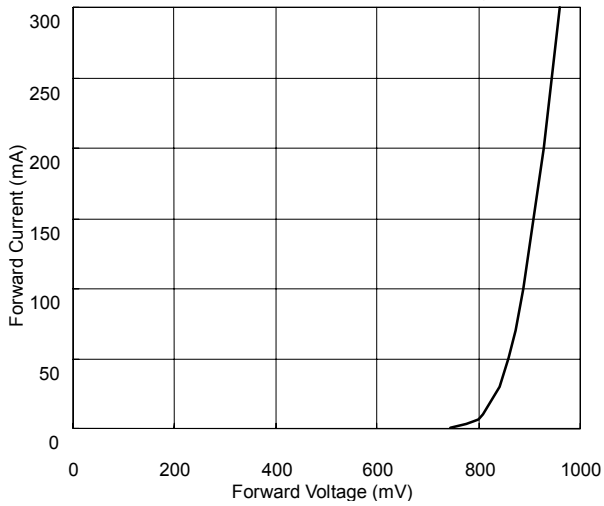

ZD5229B Reverse Current vs Reverse Voltage

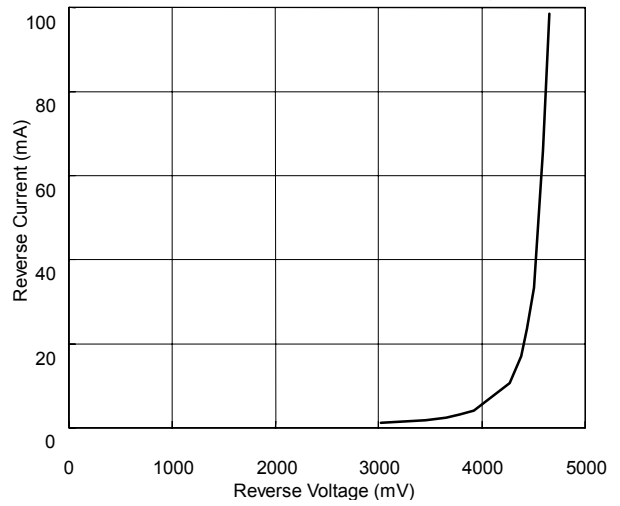

ZD5230B Forward Current vs Forward Voltage

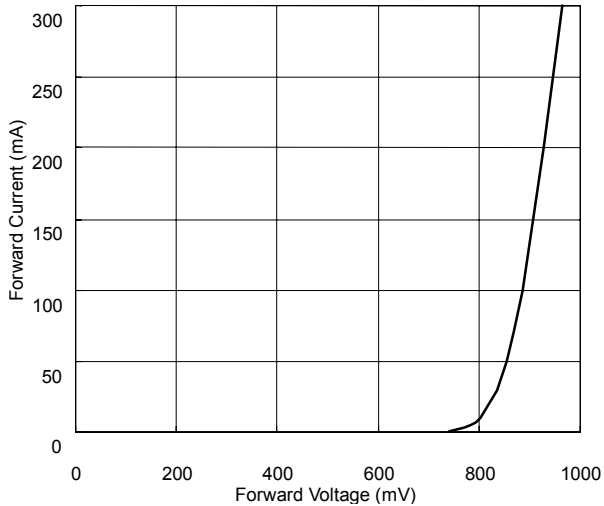

ZD5230B Reverse Current vs Reverse Voltage

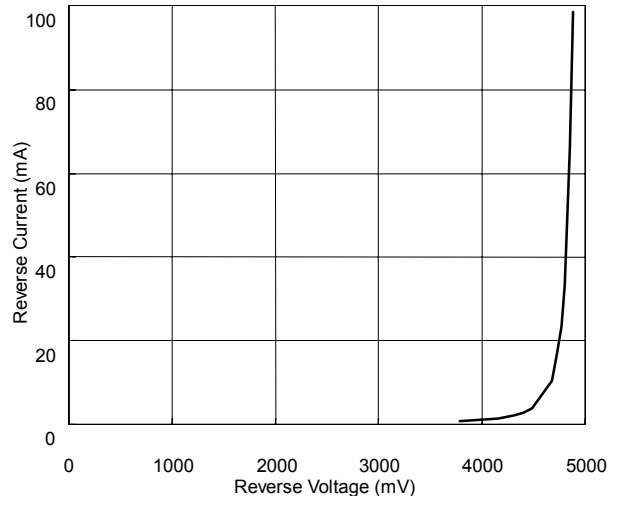



ZD5231B Forward Current vs Forward Voltage

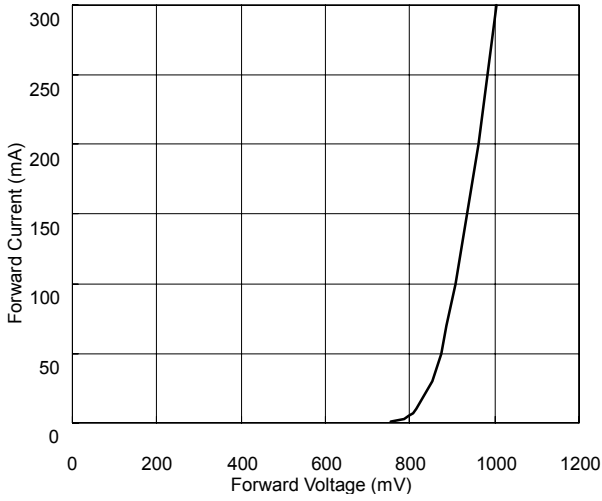

ZD5231B Reverse Current vs Reverse Voltage

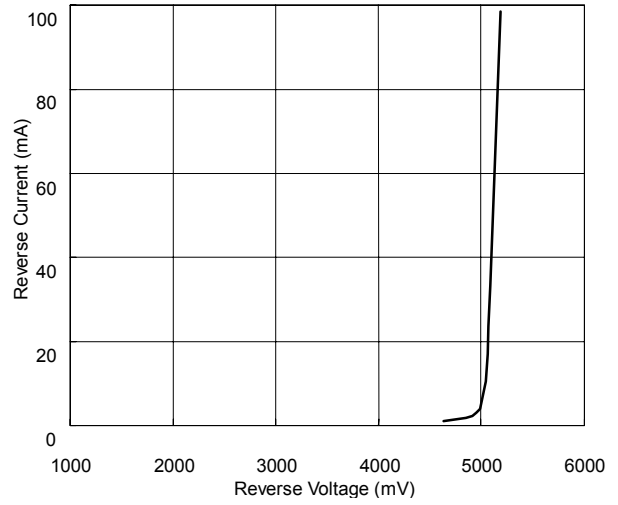

ZD5232B Forward Current vs Forward Voltage

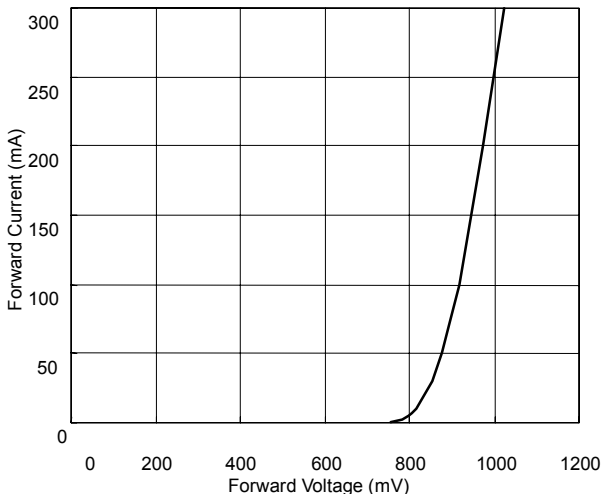

ZD5232B Reverse Current vs Reverse Voltage

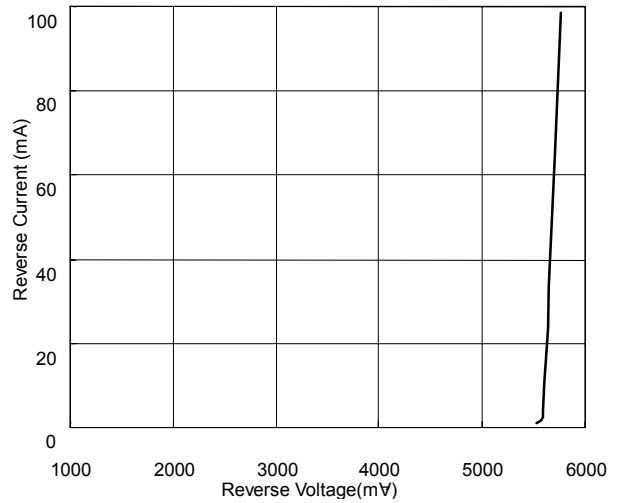

ZD5233B Forward Current vs Forward Voltage

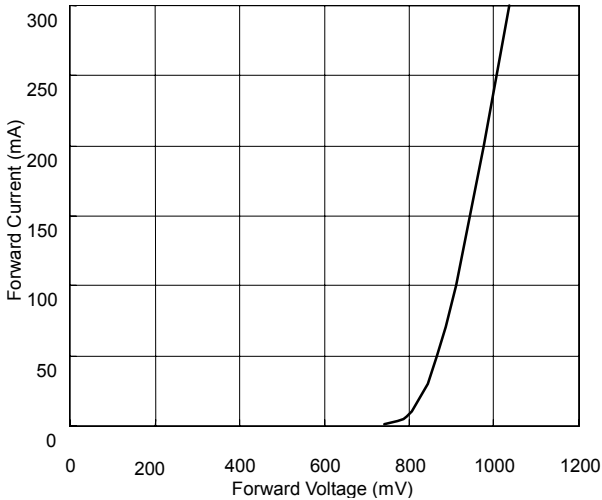

ZD5233B Reverse Current vs Reverse Voltage

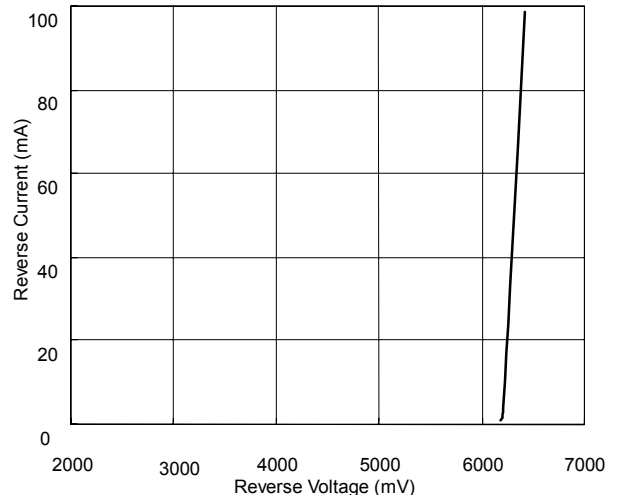

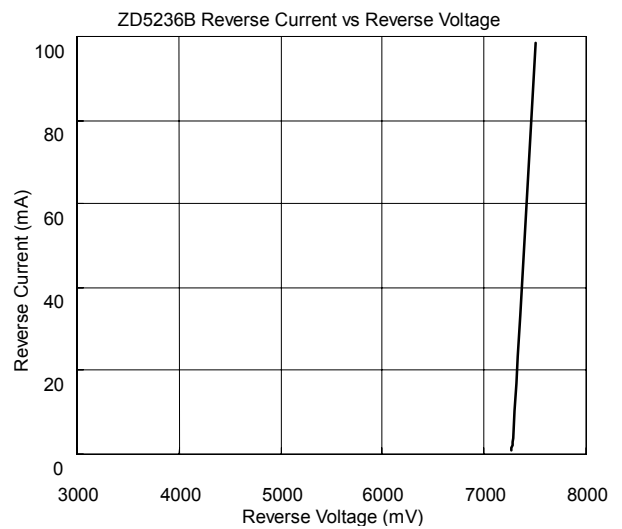
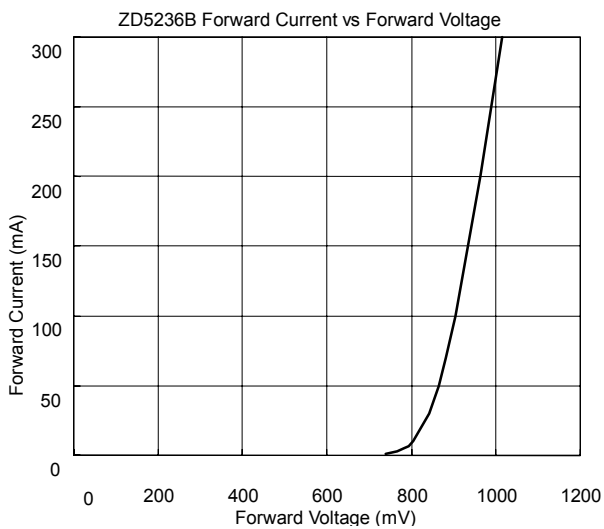
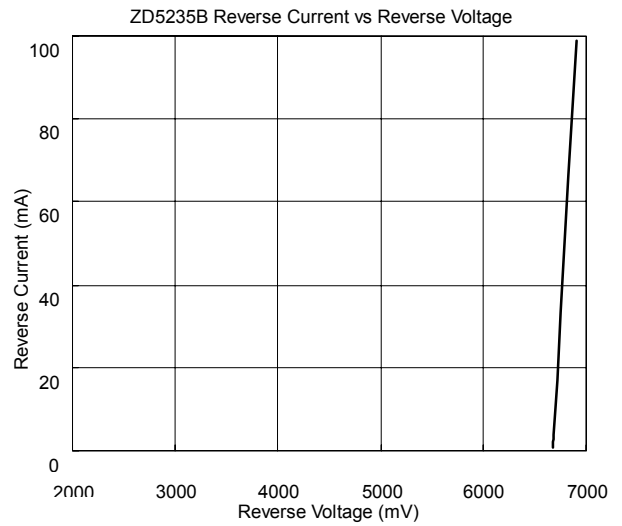
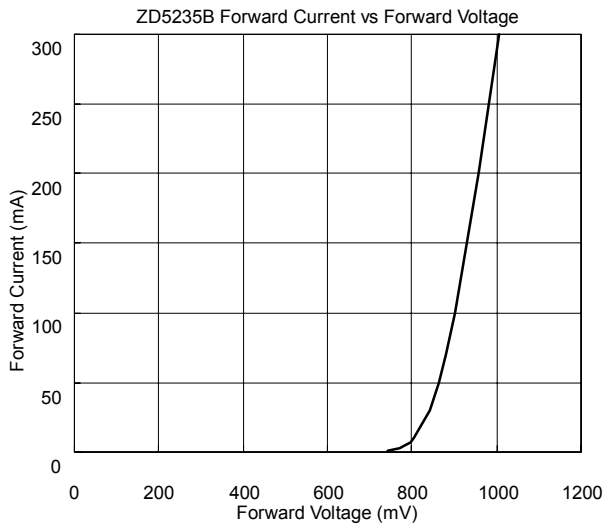
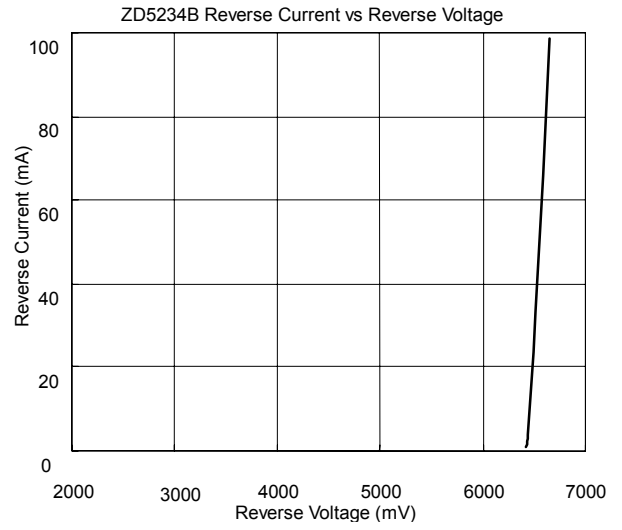
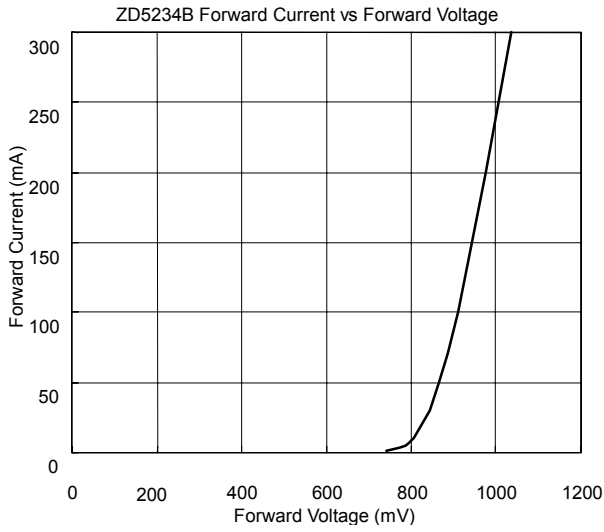

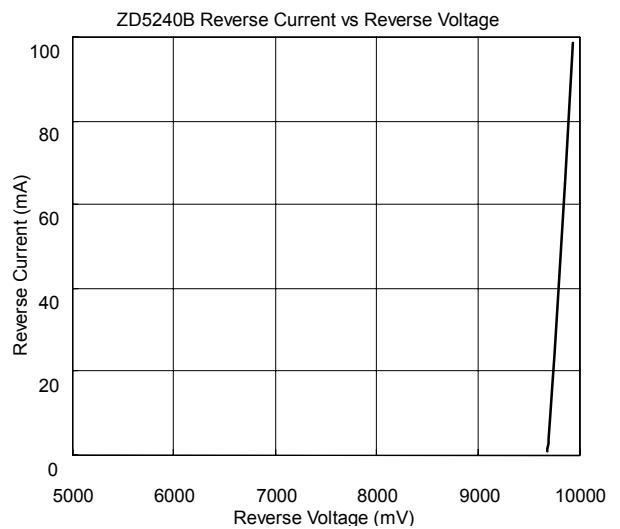
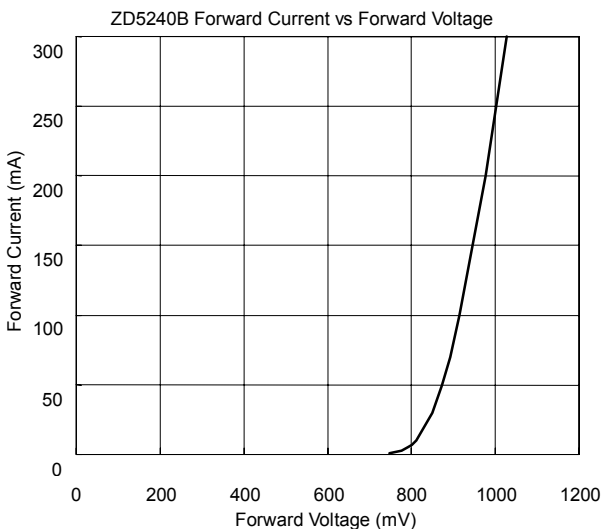
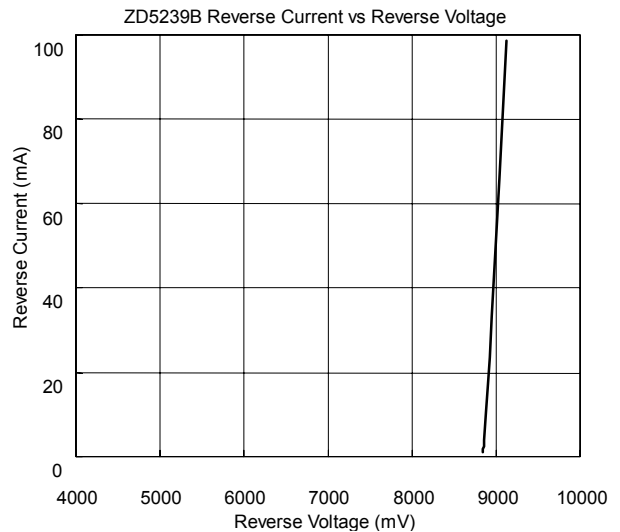
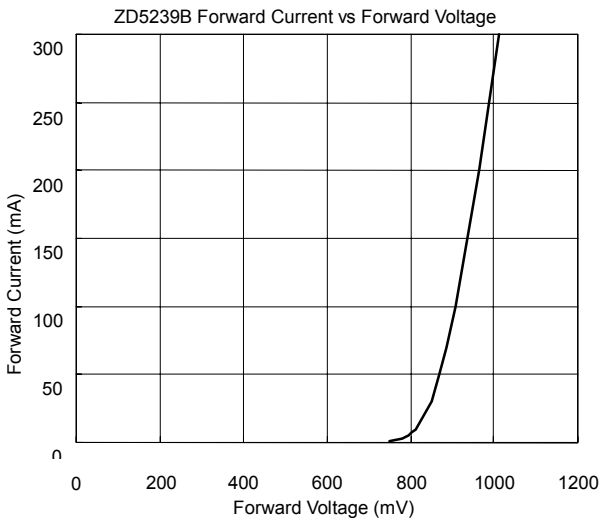
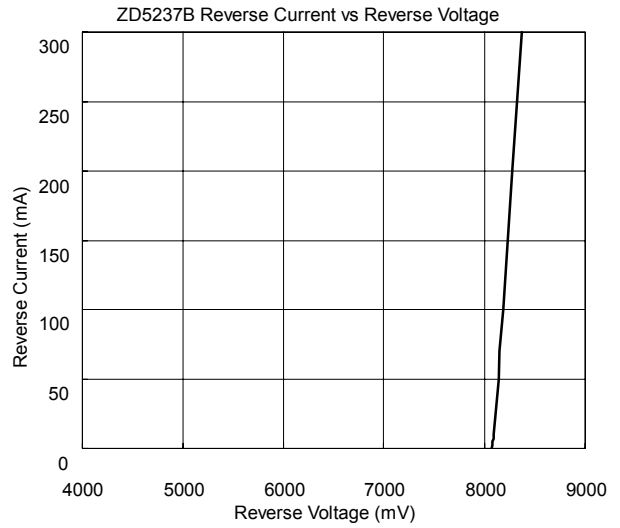
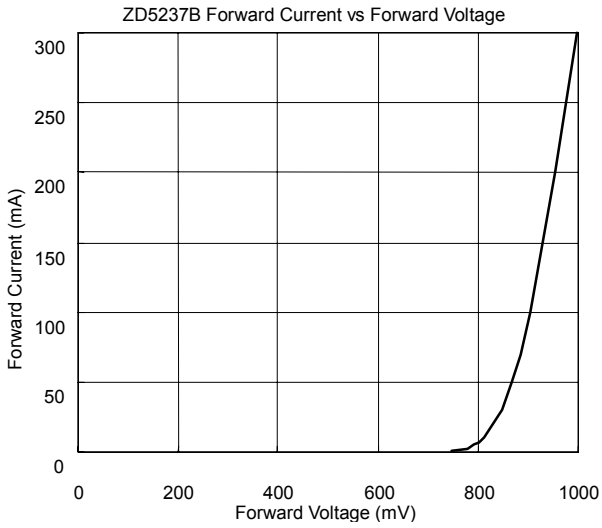

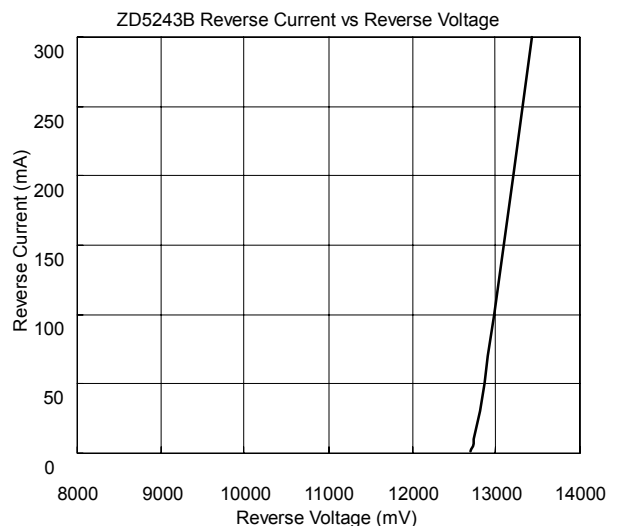
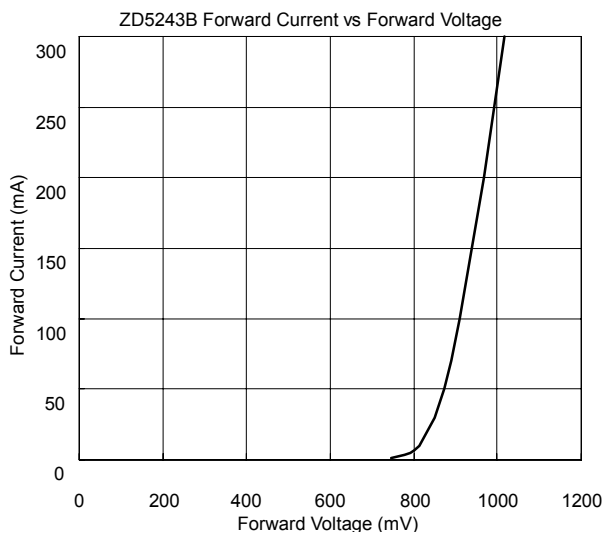
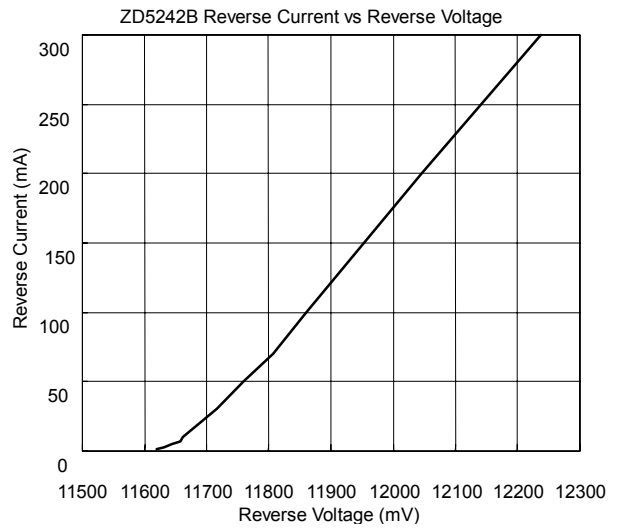
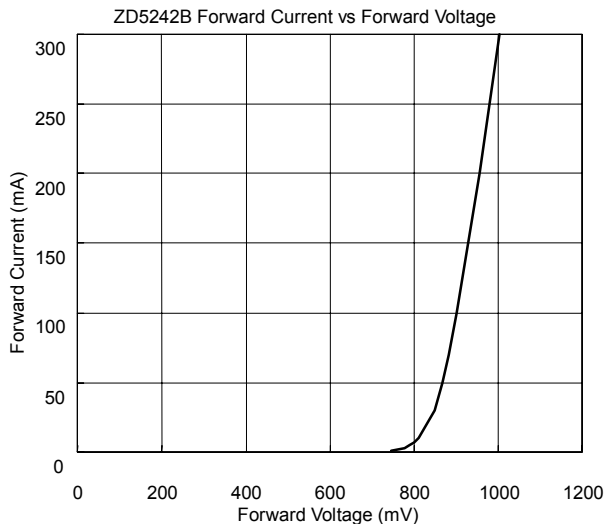
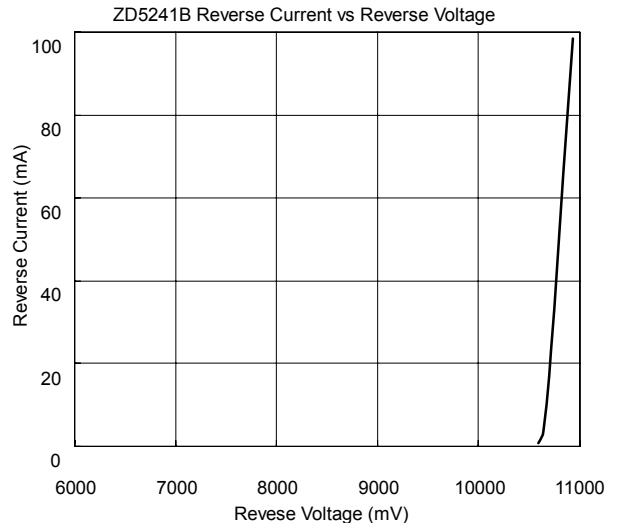
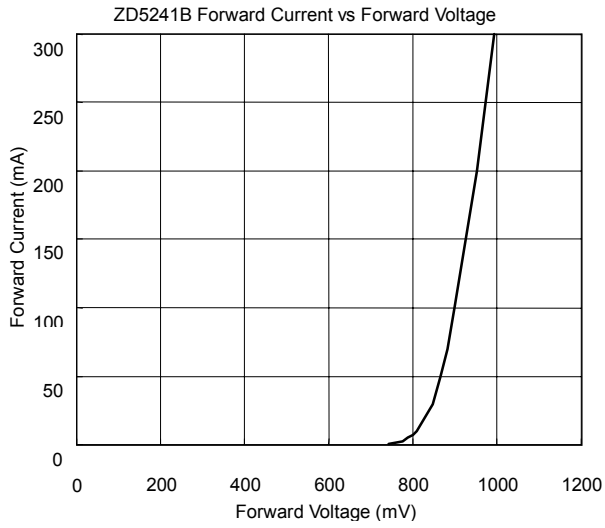



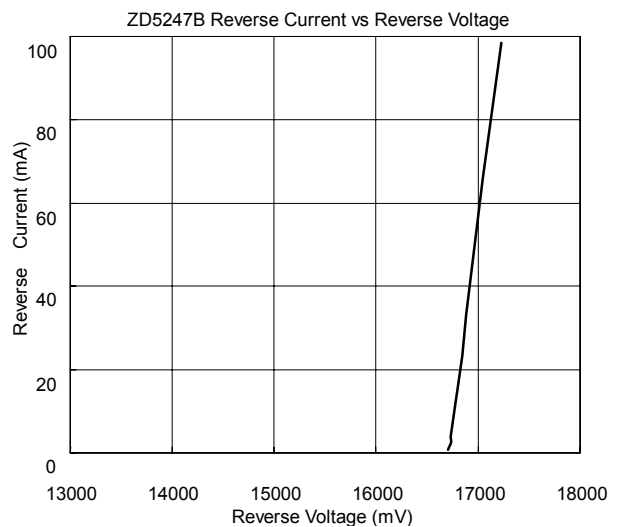
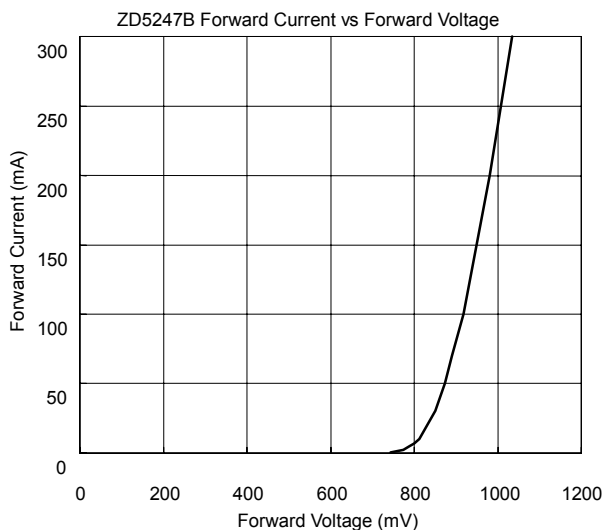
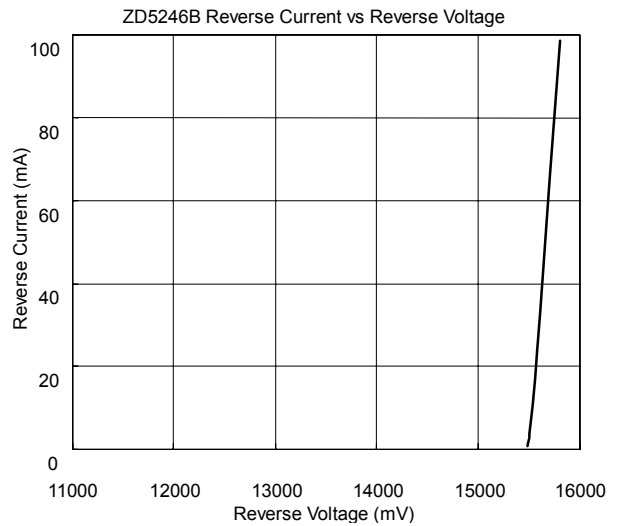
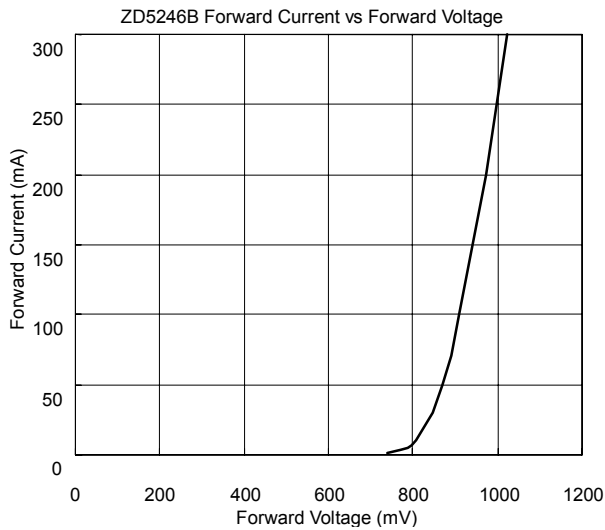
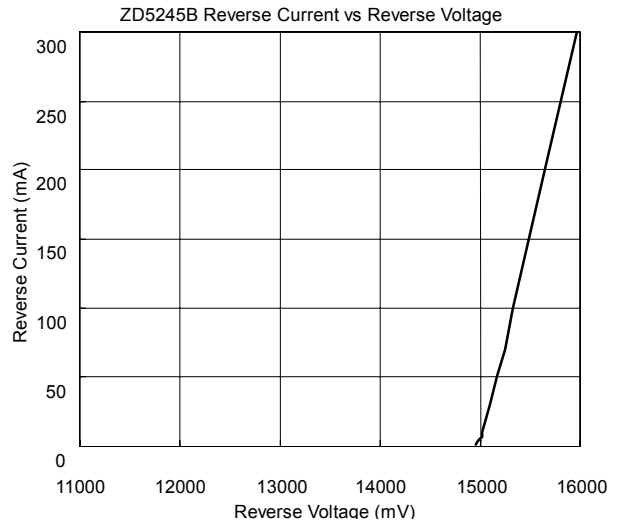
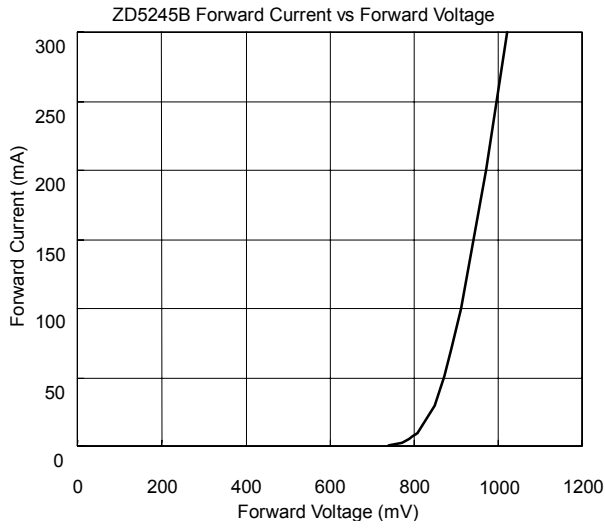

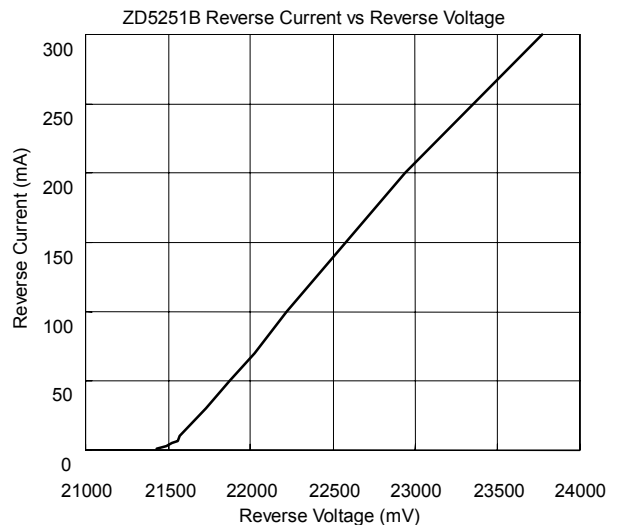
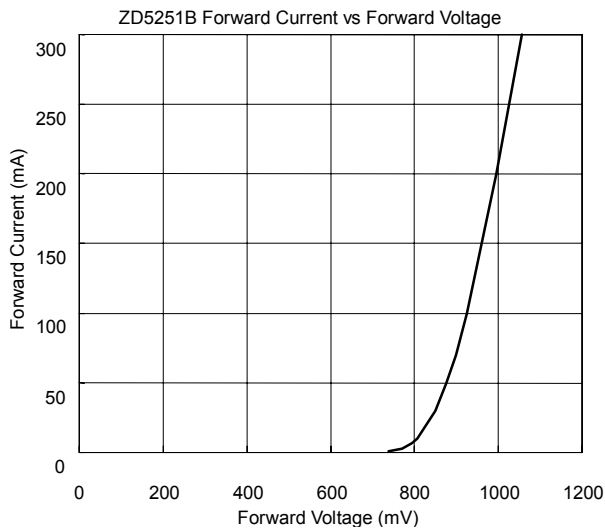
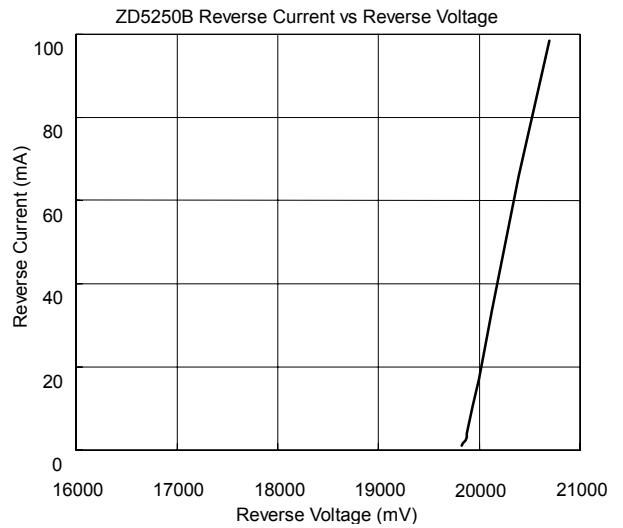
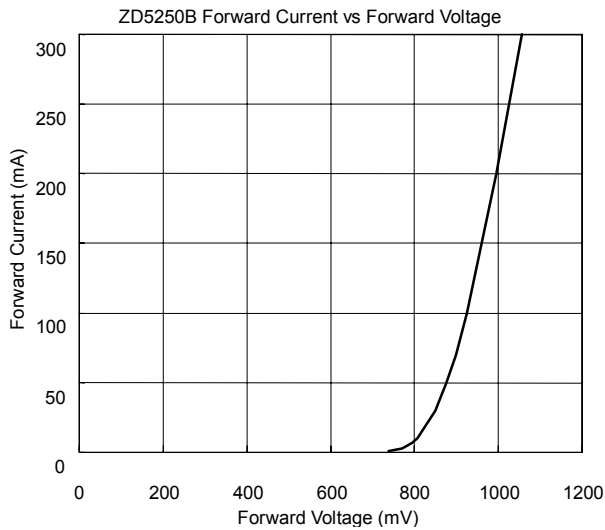
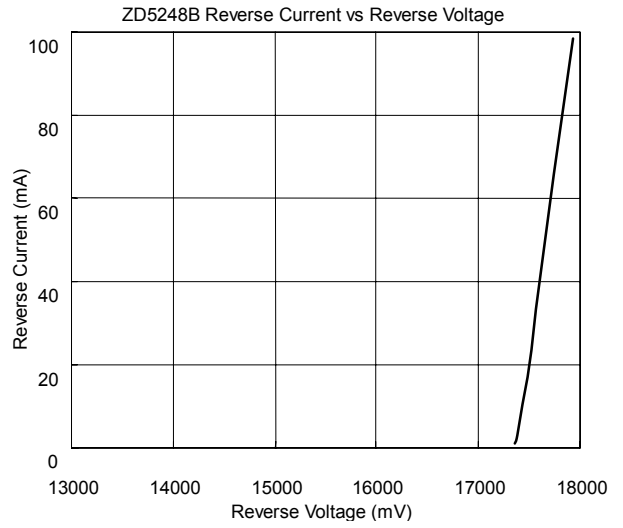
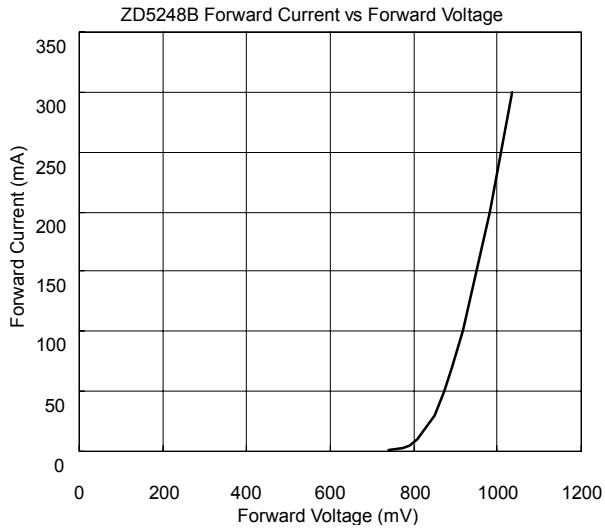



ZD5252B Forward Current vs Forward Voltage

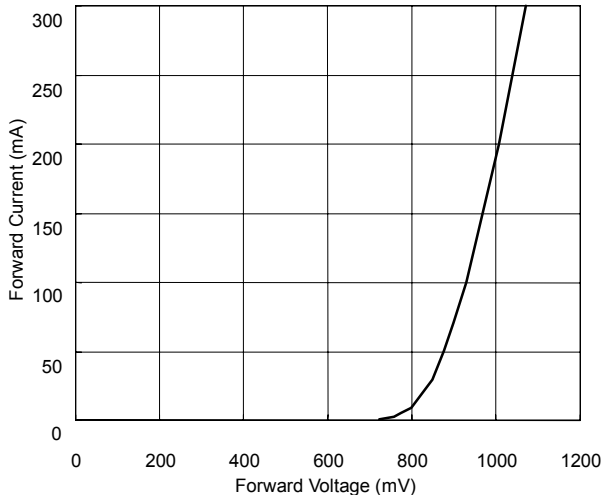

ZD5252B Reverse Current vs Reverse Voltage

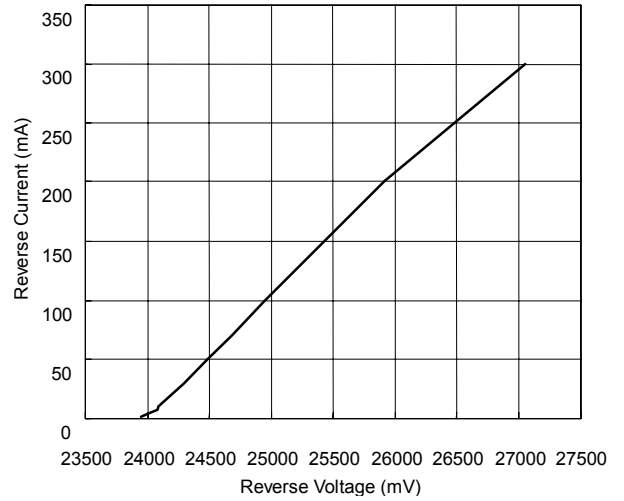

ZD5254B Forward Current vs Forward Voltage

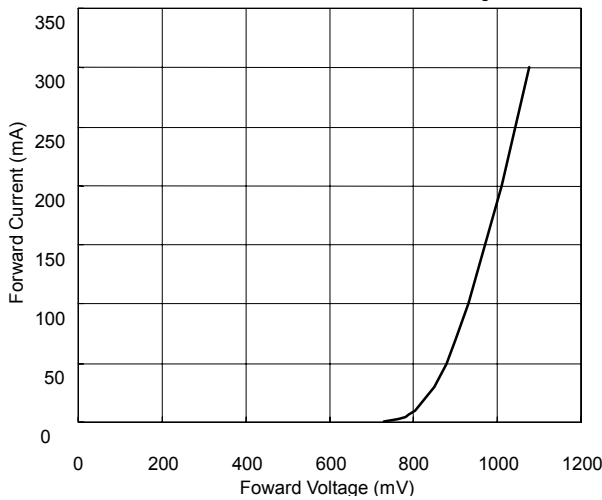

ZD5254B Reverse Current vs Reverse Voltage

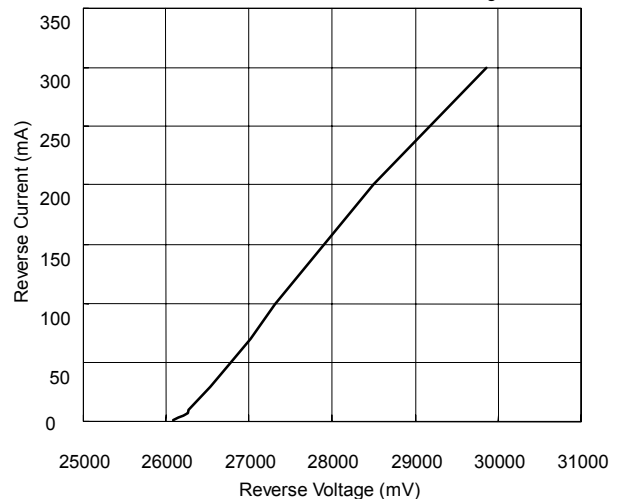

ZD5256B Forward Current vs Forward Voltage

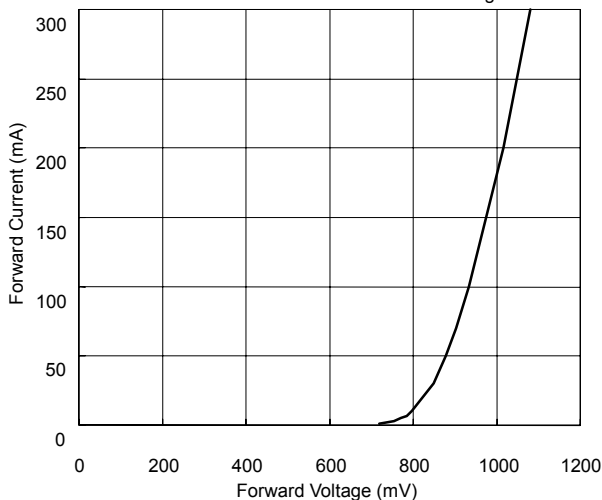

ZD5256B Reverse Current vs Reverse Voltage

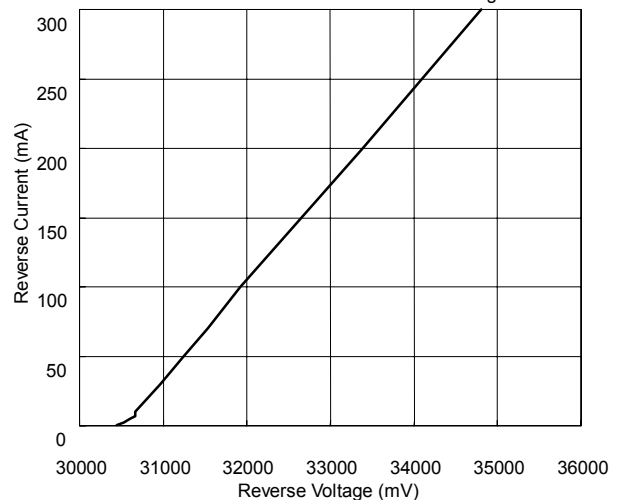

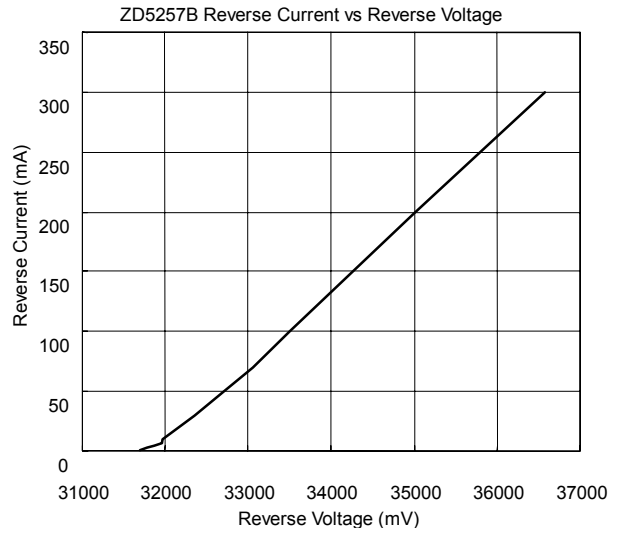
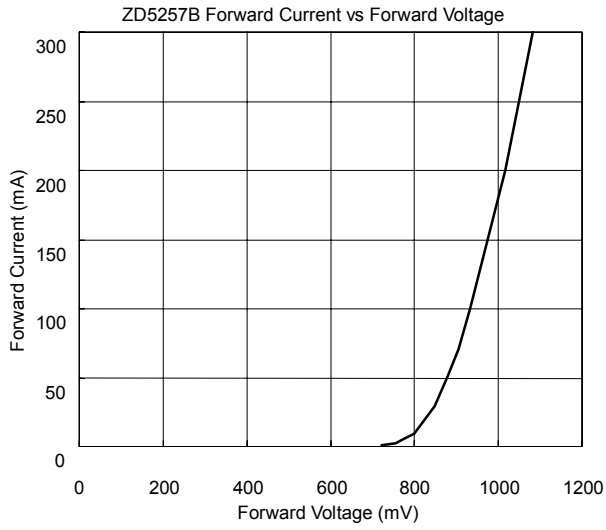



## SOD-323 Dimension

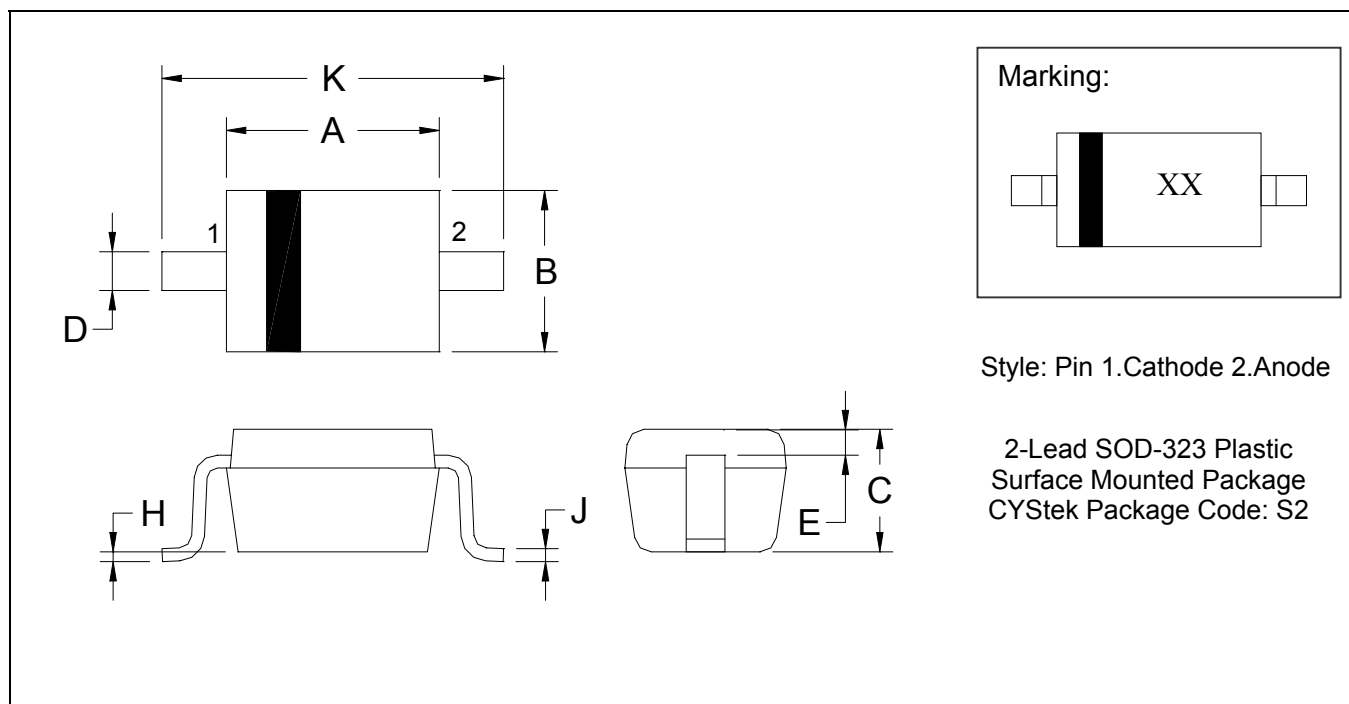

\*: Typical

DIM	Inches		Millimeters		DIM	Inches		Millimeters	
	Min.	Max.	Min.	Max.		Min.	Max.	Min.	Max.
A	0.0630	0.0709	1.60	1.80	E	0.0060	-	0.15	-
B	0.0453	0.0531	1.15	1.35	H	0.0000	0.0040	0.00	0.10
C	0.0315	0.0394	0.80	1.00	J	0.0035	0.0070	0.089	0.177
D	0.0098	0.0157	0.25	0.40	K	0.0906	0.1063	2.30	2.70

Notes: 1.Controlling dimension : millimeters.  
 2.Lead thickness specified per L/F drawing with solder plating.  
 3.If there is any question with packing specification or packing method, please contact your local CYStek sales office.

## Material:

- Lead: 42 Alloy ; solder plating
- Mold Compound: Epoxy resin family, flammability solid burning class: UL94V-0

**Important Notice:**

- All rights are reserved. Reproduction in whole or in part is prohibited without the prior written approval of CYStek.
- CYStek reserves the right to make changes to its products without notice.
- CYStek **semiconductor products are not warranted to be suitable for use in Life-Support Applications, or systems.**
- CYStek assumes no liability for any consequence of customer product design, infringement of patents, or application assistance.