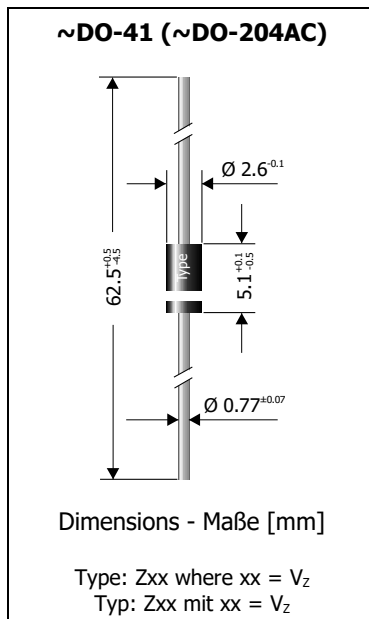

ZPY1 ... ZPY200
Zener Diodes (non-planar technology)
Flächendiffundierte Zener-Dioden

P_{tot} = 1.3 W
V_Z = 1 V ... 200 V
T_{jmax} = 150°C

Version 2016-11-23

**Typical Applications**

Voltage stabilization and regulators
 (For overvoltage protection
 – uni- and bi-directional – see
 TVS diodes BZW04/P4KE series)
 Commercial grade ¹⁾)

Features

High power dissipation
 V_Z up to 200 V
 Compliant to RoHS, REACH,
 Conflict Minerals ¹⁾)

Mechanical Data ¹⁾

Taped in ammo pack	5000
Weight approx.	0.4 g
Case material	UL 94V-0
Solder & assembly conditions	260°C/10s MSL N/A

**Typische Anwendungen**

Spannungsstabilisierung und -regler
 (Für Überspannungsschutz
 – uni- und bidirektional – siehe
 TVS-Diodenreihe BZW04/P4KE)
 Standardausführung ¹⁾)

Besonderheiten

Hohe Leistungsfähigkeit
 V_Z bis zu 200 V
 Konform zu RoHS, REACH,
 Konfliktmineralien ¹⁾)

Mechanische Daten ¹⁾

Gegurtet in Ammo-Pack	Gewicht ca.
	Gehäusematerial
	Löt- und Einbaubedingungen

Standard Zener voltage tolerance is graded to the international E 24 (~ ±5%) standard.
 Other voltage tolerances and higher Zener voltages on request.

Die Toleranz der Zener-Spannung ist in der Standard-Ausführung gestuft nach der internationalen Reihe E 24 (~ ±5%). Andere Toleranzen oder höhere Arbeitsspannungen auf Anfrage.

Maximum ratings ²⁾**Grenzwerte ²⁾**

Power dissipation – Verlustleistung	T _A = 50°C	P _{tot}	1.3 W ³⁾
Non repetitive peak power dissipation, t < 1 ms Einmalige Impuls-Verlustleistung, t < 1 ms		P _{ZSM}	40 W ³⁾
Operating junction temperature – Sperrschichttemperatur Storage temperature – Lagerungstemperatur		T _j T _S	--50...+150°C -50...+175°C

Characteristics**Kennwerte**

Thermal resistance junction to ambient Wärmewiderstand Sperrschicht – Umgebung	R _{thA}	<45 K/W ³⁾
Thermal resistance junction to lead Wärmewiderstand Sperrschicht – Anschlussdraht	R _{thL}	<15 K/W

- Please note the [detailed information on our website](#) or at the beginning of the data book
Bitte beachten Sie die [detaillierten Hinweise auf unserer Internetseite](#) bzw. am Anfang des Datenbuches
- T_A = 25°C unless otherwise specified – T_A = 25°C wenn nicht anders angegeben
- Valid, if leads are kept at ambient temperature at a distance of 10 mm from case
Gültig, wenn die Anschlussdrähte in 10 mm Abstand vom Gehäuse auf Umgebungstemperatur gehalten werden
- Tested with pulses – Gemessen mit Impulsen
- The ZPY1 is a diode operated in forward. Hence, the index of all parameters should be "F" instead of "Z".
The cathode, indicated by a white band, has to be connected to the negative pole.
Die ZPY1 ist eine in Durchlass betriebene Si-Diode. Daher ist bei allen Kenn- und Grenzwerten der Index "F" anstatt "Z" zu setzen. Die mit weißem Balken gekennzeichnete Kathode ist mit dem Minuspol zu verbinden.

Characteristics

 (T_j = 25°C unless otherwise specified)

Kennwerte

 (T_j = 25°C wenn nicht anders spezifiziert)

Type Typ	Zener voltage ⁴⁾ Zener-Spannung ⁴⁾ I _Z = I _{Ztest}		Test current Meßstrom I _{Ztest} [mA]	Dynamic resistance Diff. Widerstand I _{Ztest} / f = 1 kHz r _{zj} [Ω]	Temp. Coeffic. of Z-voltage ...der Z-Spannung α _{VZ} [10 ⁻⁴ /°C]	Reverse volt. Sperrspanng. I _R = 1 μA V _R [V]	Z-current ³⁾ Z-Strom ³⁾ T _A = 50°C I _{Zmax} [mA]
	V _{zmin} [V]	V _{zmax} [V]					
ZPY1 ⁵⁾	0.71	0.82	100	0.5 (<1)	-26...-16	-	1000
ZPY5.6	5.2	6.0	100	1 (<3)	-3...+5	> 0.5 / 3 μA	217
ZPY6.2	5.8	6.6	100	1 (<2)	-1...+6	> 1.5	197
ZPY6.8	6.4	7.2	100	1 (<2)	0...+7	> 2	181
ZPY7.5	7.0	7.9	100	1 (<2)	0...+7	> 2	165
ZPY8.2	7.7	8.7	100	1 (<2)	+3...+8	> 3.5	149
ZPY9.1	8.5	9.6	50	2 (<4)	+3...+8	> 3.5	135
ZPY10	9.4	10.6	50	2 (<4)	+5...+9	> 5	123
ZPY11	10.4	11.6	50	4 (<7)	+5...+10	> 5	112
ZPY12	11.4	12.7	50	4 (<7)	+5...+10	> 7	102
ZPY13	12.4	14.1	50	5 (<10)	+5...+10	> 7	92
ZPY15	13.8	15.6	50	5 (<10)	+5...+10	> 10	83
ZPY16	15.3	17.1	25	6 (<15)	+6...+11	> 10	76
ZPY18	16.8	19.1	25	6 (<15)	+6...+11	> 10	68
ZPY20	18.8	21.2	25	6 (<15)	+6...+11	> 10	61
ZPY22	20.8	23.3	25	6 (<15)	+6...+11	> 12	56
ZPY24	22.8	25.6	25	7 (<15)	+6...+11	> 12	51
ZPY27	25.1	28.9	25	7 (<15)	+6...+11	> 14	45
ZPY30	28	32	25	8 (<15)	+6...+11	> 14	41
ZPY33	31	35	25	8 (<15)	+6...+11	> 17	37
ZPY36	34	38	10	16 (<40)	+6...+11	> 17	34
ZPY39	37	41	10	20 (<40)	+6...+11	> 20	32
ZPY43	40	46	10	24 (<45)	+7...+12	> 20	28
ZPY47	44	50	10	24 (<45)	+7...+12	> 24	26
ZPY51	48	54	10	25 (<60)	+7...+12	> 24	24
ZPY56	52	60	10	25 (<60)	+7...+12	> 28	22
ZPY62	58	66	10	25 (<80)	+8...+13	> 28	20
ZPY68	64	72	10	25 (<80)	+8...+13	> 34	18
ZPY75	70	79	10	30 (<100)	+8...+13	> 34	16
ZPY82	77	88	10	30 (<100)	+8...+13	> 41	15
ZPY91	85	96	5	40 (<200)	+9...+13	> 41	14
ZPY100	94	106	5	60 (<200)	+9...+13	> 50	12
ZPY110	104	116	5	80 (<250)	+9...+13	> 50	11
ZPY120	114	127	5	80 (<250)	+9...+13	> 60	10
ZPY130	124	141	5	90 (<300)	+9...+13	> 60	9
ZPY150	138	156	5	100 (<300)	+9...+13	> 75	8
ZPY160	153	171	5	110 (<350)	+9...+13	> 75	8
ZPY180	168	191	5	120 (<350)	+9...+13	> 90	7
ZPY200	188	212	5	150 (<350)	+9...+13	> 90	6

3,4,5 Notes see previous page – Fußnoten siehe vorhergehende Seite

ZPY1 ... ZPY200

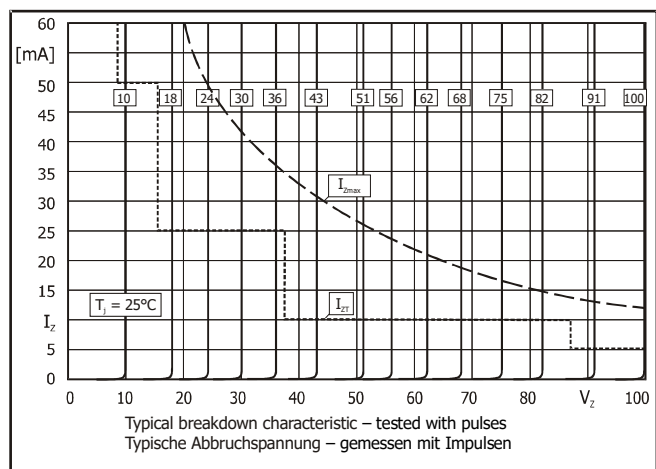
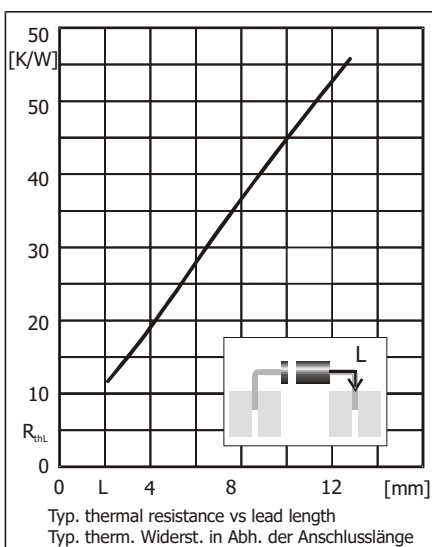
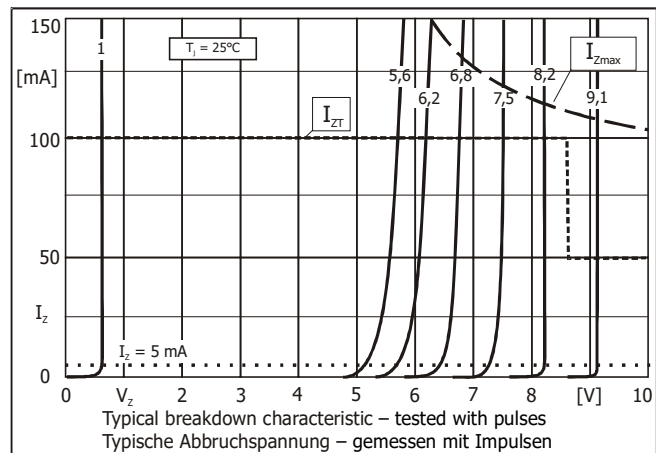
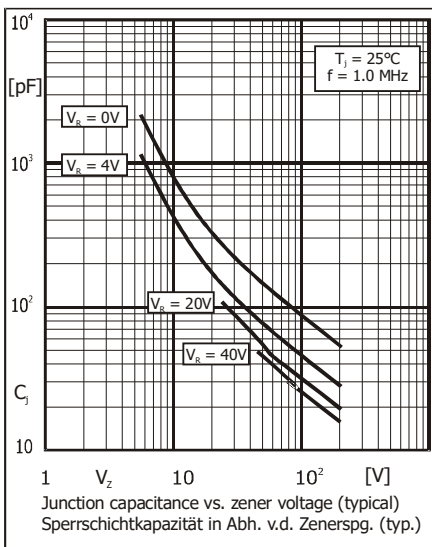
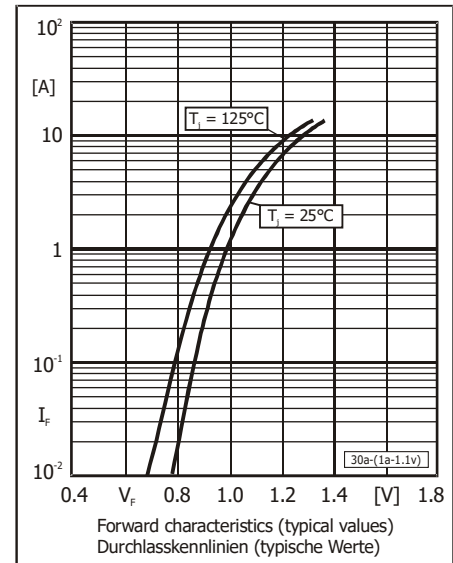
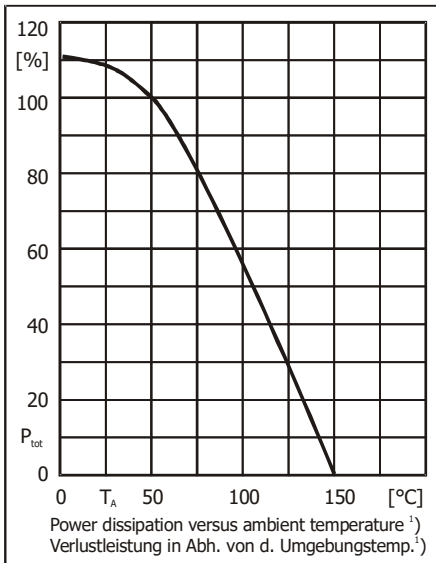

Disclaimer: See data book page 2 or [website](#)
Haftungsausschluss: Siehe Datenbuch Seite 2 oder [Internet](#)

1 Mounted on P.C. board with 25 mm² copper pads at each terminal
Montage auf Leiterplatte mit 25 mm² Kupferbelag (Löt-pad an jedem Anschluss)