

PRECISION 1.25 VOLT MICROPOWER VOLTAGE REFERENCE

ZREF12

ISSUE 2 - MARCH 1998

DEVICE DESCRIPTION

The ZREF12 uses a bandgap circuit design to achieve a precision micropower voltage reference of 1.24 volts. The device is available in a small outline surface mount package, ideal for applications where space saving is important, as well as packages for through hole requirements.

The ZREF12 design provides a stable voltage without an external capacitor and is stable with capacitive loads. The ZREF12 is recommended for operation between 50 μ A and 5mA and so is ideally suited to low power and battery powered applications.

Excellent performance is maintained to an absolute maximum of 25mA, however the rugged design and 20 volt processing allows the reference to withstand transient effects and currents up to 200mA. Superior switching capability allows the device to reach stable operating conditions in only a few microseconds.

FEATURES

- Small outline SO8 and TO92 style packages
- No stabilising capacitor required
- Typical T_C 30ppm/ $^{\circ}$ C
- Typical slope resistance 0.65 Ω
- $\pm 1\%$ tolerance
- Industrial temperature range (Military temperature range available on request)
- Operating current 50 μ A to 5mA
- Transient response, stable in less than 10 μ s
- Alternative package options and tolerances available

APPLICATIONS

- Battery powered and portable equipment.
- Metering and measurement systems.
- Instrumentation.
- Precision power supplies.
- Test equipment.
- Data acquisition systems

SCHEMATIC DIAGRAM

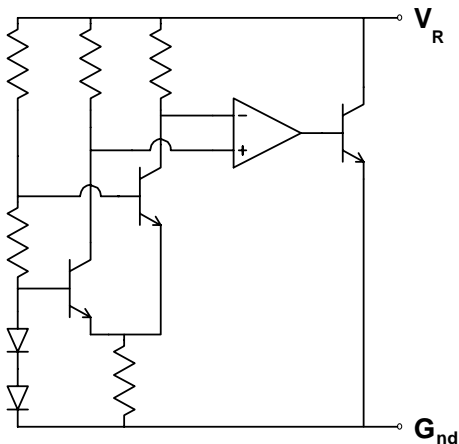

ZREF12

ABSOLUTE MAXIMUM RATING

Reverse Current	25mA
Forward Current	25mA
Operating Temperature	-40 to 85°C
Storage Temperature	-55 to 125°C

Power Dissipation (T_{amb}=25°C)

E-Line, 3 pin (TO92)	500mW
E-Line, 2 pin (TO92)	500mW
SO8	625mW

ELECTRICAL CHARACTERISTICS

TEST CONDITIONS (Unless otherwise stated) T_{amb}=25°C

SYMBOL	PARAMETER	CONDITIONS	LIMITS			TOL. %	UNITS
			MIN	TYP	MAX		
V _R	Reverse Breakdown Voltage	I _R =150μA	1.228	1.24	1.252	1	V
I _{MIN}	Minimum Operating Current			30	50		μA
I _R	Recommended Operating Current		0.05		5		mA
T _C †	Average Reverse Breakdown Voltage Temp. Co.	I _{R(min)} to I _{R(max)}		30	90		ppm/°C
R _S §	Slope Resistance			0.65	2		Ω
Z _R	Reverse Dynamic Impedance	I _R = 1mA f = 100Hz I _{AC} =0.1 I _R		0.5	1		Ω
E _N	Wideband Noise Voltage	I _R = 150μA f = 100Hz to 10kHz		60			μV(rms)

$$\dagger T_C = \frac{(V_{R(max)} - V_{R(min)}) \times 1000000}{V_R \times (T_{(max)} - T_{(min)})}$$

Note: V_{R(max)} - V_{R(min)} is the maximum deviation in reference voltage measured over the full operating temperature range.

$$\S R_S = \frac{V_R \text{ Change}(I_{R(min)} \text{ to } I_{R(max)})}{I_{R(max)} - I_{R(min)}}$$

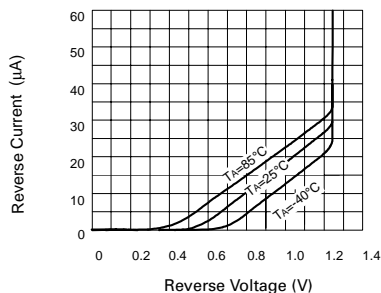

Reverse Characteristics

TYPICAL CHARACTERISTICS

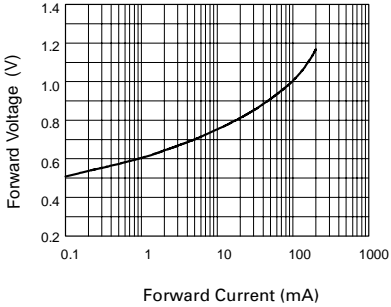

Forward Characteristics

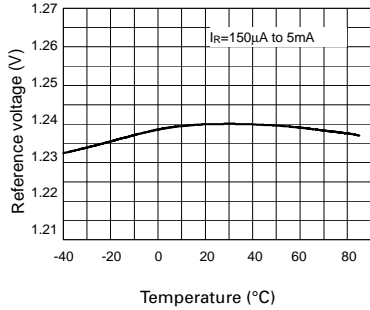

Temperature Drift

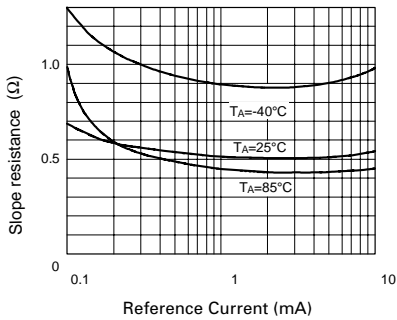

Slope Resistance v Current

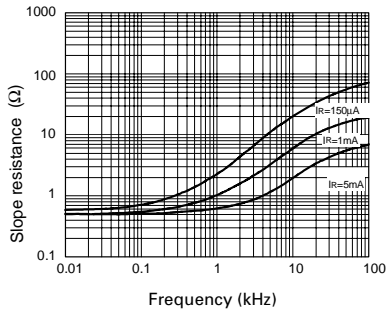

Slope Resistance v Frequency

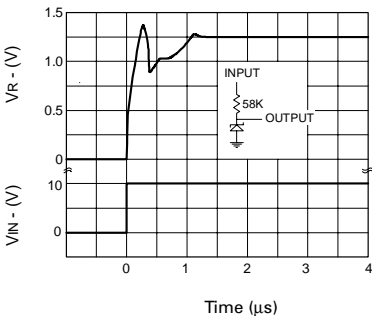

Transient Response ($I_R=150\mu\text{A}$)

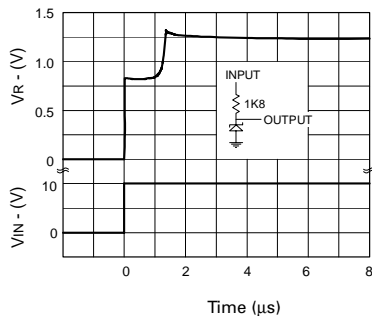

Transient Response ($I_R=5\text{mA}$)

ZREF12

CONNECTION DIAGRAMS

E-Line, 2 pin Package Suffix - Y

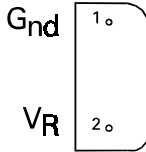

Bottom View

E-Line, 3 pin, Rev Package Suffix - R

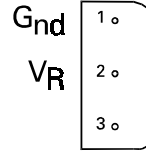

*Bottom View -
Pin 3 floating or connected to pin 1*

SO8 Package Suffix - N8

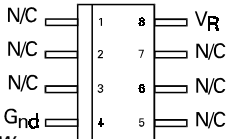

Top View

ORDERING INFORMATION

Part No	Tol%	Package	Partmark
ZREF12	1	E-Line †	ZREF12
ZREF12Z	1	E-Line *	ZREF12
ZREF12D	1	SO8	ZREF12

* E-Line 3 pin Reversed

† E-Line 2 pin