

5.0V LOW POWER PRECISION REFERENCE SOURCE

ZRT050

ISSUE 1 - OCTOBER 1995

DEVICE DESCRIPTION

The ZRT050 is a monolithic integrated circuit providing a precise stable reference voltage of 4.9V at 500 μ A.

The circuit features a knee current of 150 μ A and operation over a wide range of temperatures and currents.

The ZRT050 is available in a 3-pin metal can package for through hole applications as well as SOT223 and SO8 packages for surface mount applications. Each package option offers a trim facility whereby the output voltage can be adjusted as shown in Fig.1. This facility is used when compensating for system errors or setting the reference output to a particular value. When the trim facility is not used, the pin should be left open circuit.

FEATURES

- Trimmable output
- Excellent temperature stability
- Low output noise figure
- Available in two temperature ranges
- 1 and 2% initial voltage tolerance versions available
- No external stabilising capacitor required in most cases
- Low slope resistance
- TO18 package
- SOT223 and SO8 small outline packages

SCHEMATIC DIAGRAM

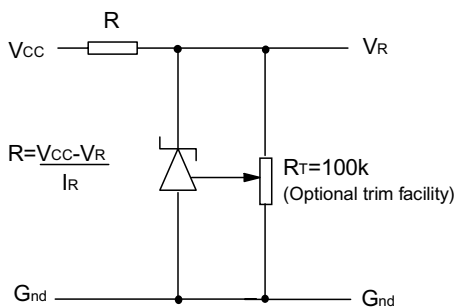

Figure 1:

This circuit will allow the reference to be trimmed over a wide range. The device is specified over a $\pm 5\%$ trim range.

ZRT050

ABSOLUTE MAXIMUM RATING

Reverse Current	60mA \emptyset
Operating Temperature	A grade -55°C to 125°C C grade 0°C to 70°C
Storage Temperature	TO18 -55 °C to 175 °C SO8, SOT223 -55 °C to 125 °C

Power Dissipation ($T_{amb}=25^{\circ}\text{C}$)

TO18	300mW
SO8	625mW
SOT223	2W
\emptyset Above 25°C this figure should be linearly derated to 12mA at 125°C	

TEMPERATURE DEPENDENT ELECTRICAL CHARACTERISTICS

SYMBOL	PARAMETER	INITIAL VOLTAGE TOLERANCE %	GRADE A -55°C TO 125°C		GRADE C 0°C TO 70°C		UNITS
			TYP	MAX	TYP	MAX	
ΔV_R	Output voltage change over relevant temperature range (See note (a))	1 & 2	13.5	45.0	5.4	17.2	mV
$T_C V_R$	Output voltage temperature coefficient (See note (b))	1 & 2	15.0	50.0	15.0	50.0	ppm/°C

ELECTRICAL CHARACTERISTICS

(at $T_{amb}=25^{\circ}\text{C}$ and trim pin unless otherwise stated)

SYMBOL	PARAMETER	MIN.	TYP.	MAX.	UNITS	COMMENTS
V_R	Output voltage 1% tolerance (A1,C1) 2% tolerance (C2)	4.85 4.80	4.90 4.90	4.95 5.00	V	$I_R=500\mu\text{A}$
ΔV_{TRIM}	Output voltage adjustment range		± 5		%	$R_T=100\text{k}\Omega$
$T_C \Delta V_{TRIM}$	Change in $T_C V_R$ with output adjustment		2.5		ppm/°C/%	
I_R	Operating current range	0.15		60	mA	See note (c)
t_{on} t_{off}	Turn-on time Turn-off time		100 0.3		μs	$R_L=1\text{k}\Omega$
e_{np-p}	Output voltage noise (over the range 0.1 to 10Hz)		50		μV	Peak to peak measurement
R_S	Slope resistance		1.25	2.0	Ω	$I_R = 0.5\text{mA}$ to 5mA See note (d)

TYPICAL CHARACTERISTICS

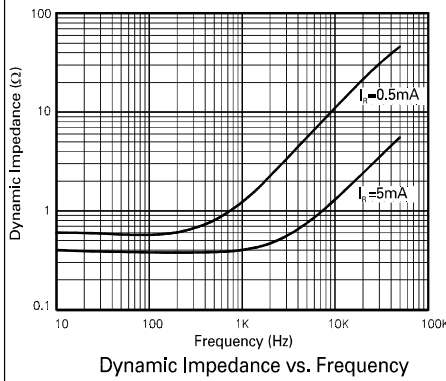
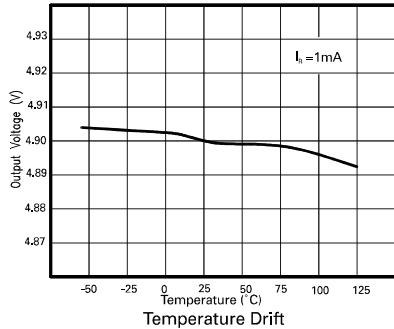
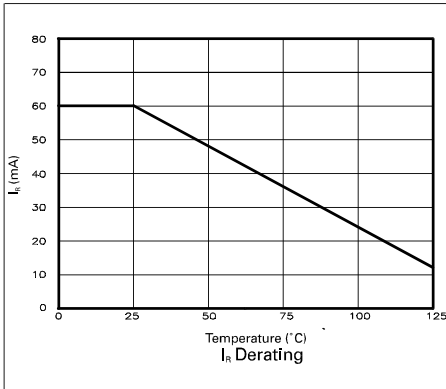

NOTES

(a) Output change with temperature (VR)

The absolute maximum difference between the maximum output voltage and the minimum output voltage over the specified temperature range

$$\Delta V_R = V_{max} - V_{min}$$

(b) Output temperature coefficient (TcVR)

The ratio of the output change with temperature to the specified temperature range expressed in ppm/°C

$$T_c V_R = \frac{\Delta V_R \times 10^6}{V_R \times \Delta T} \text{ ppm}/^\circ\text{C}$$

ΔT = Full temperature range

(c) Operating current (IR)

Maximum operating current must be derated as indicated in maximum ratings.

(d) Slope resistance (RS)

The slope resistance is defined as :

$$R_S = \frac{\text{change in } V_R}{\text{specified current range}}$$

$$\Delta I = 5 - 0.5 = 4.5 \text{ mA (typically)}$$

(e) Line regulation

The ratio of change in output voltage to the change in input voltage producing it.

$$\frac{R_S \times 100}{V_R \times R_{S_{source}}} \% / V$$

ZRT050

CONNECTION DIAGRAMS

SOT223 Package Suffix - G

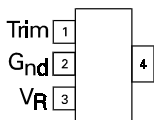

Top View
Pin 4 floating or connected to pin 2

TO18 Package Suffix - None

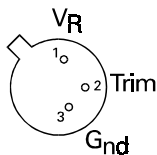

Bottom View -
Case is internally connected to pin 3

SO8 Package Suffix - N8

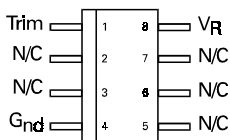

Top View

ORDERING INFORMATION

Part No	Tol%	Operating Temp.(°C)	Package	Partmark
ZRT050C2	2	0 to 70	TO18	ZRT050C2
ZRT050C1	1	0 to 70	TO18	ZRT050C1
ZRT050A1	1	-55 to 125	TO18	ZRT050A1
ZRT050GC2	2	0 to 70	SOT223	ZRT050C2
ZRT050GC1	1	0 to 70	SOT223	ZRT050C1
ZRT050GA1	1	-55 to 125	SOT223	ZRT050A1
ZRT050N8C2	2	0 to 70	SO8	ZRT050C2
ZRT050N8C1	1	0 to 70	SO8	ZRT050C1
ZRT050N8A1	1	-55 to 125	SO8	ZRT050A1