

**ZT207F, ZT208F
ZT211F, ZT213F**

Low Power 5V 1000kbps RS232 Transceivers



Features

- Meets EIA/TIA-232F and CCITT V.28/V.24 specifications for V_{CC} at $+5V \pm 10\%$
- Low Quiescent Current – 3mA typ., 6mA max.
- Low Shutdown Current (where applicable) - 1 μ A typical, 10 μ A max.
- Guaranteed Standard Data Rate 1000kbps
- Proprietary Switch-Capacitor Regulated Voltage Converters (patent pending)
- Wake Up Feature in Shutdown Mode
- Tri-State Receiver Outputs
- Latch-up Free
- ESD Protection for RS-232 I/O's ± 15 kV Human Body Model (HBM)
- Drop-in Replacements for SP207EH, SP208EH, SP211EH, SP213EH
- Standard Data Rate at 250kbps Available on ZT230E Series

General Description

The ZT230F series devices are 5V powered EIA/TIA-232 and V.28/V.24 communication interfaces with low power requirements. They consist of the combinations of five line drivers, five line receivers and the proprietary switch-capacitor regulated voltage converters. The ZT211F and ZT213F feature a low power shutdown mode which draws as little current as 1 μ A typical with receiver outputs tri-stated and wake-up function. These devices operate from a single 5V power supply at the guaranteed data rate of 1000k bits/sec with enhanced electrostatic discharge (ESD) protection in all RS232 I/O pins exceeding ± 15 kV HBM.

Applications

- Battery-Powered Applications
- Notebooks, Subnotebooks, and Palmtops
- Industrial and Embedded PCs
- Data Cables for Cell Phones and PDAs
- Terminal Adapters and POS terminals
- Peripherals interface
- Routers and HUBs

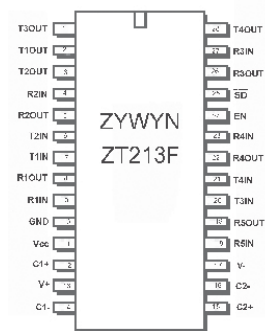

28-pin SSOP/WSOIC

Now Available in Green Package Option

Product Selection Guide And Cross Reference

Part Number	# of RS232 Tx	# of RS232 Rx	# of Rx active in SD	# of 0.1 μ F caps	Shut Down	Wake Up	TTL Tri-State	Data Rate (kbps)	ESD HBM on RS232 I/O	Pin-to-Pin Cross SIPEX	Pin-to-Pin Cross MAXIM
ZT207F	5	3	0	4	No	No	No	1000	± 15 kV	SP207EH	n/a
ZT208F	4	4	0	4	No	No	No	1000	± 15 kV	SP208EH	n/a
ZT211F	4	5	0	4	Yes	No	Yes	1000	± 15 kV	SP211EH	n/a
ZT213F	4	5	2	4	Yes	Yes	Yes	1000	± 15 kV	SP213EH	n/a



Absolute Maximum Ratings

These are stress ratings only and functional operation of the device at these ratings or any other above those indicated in the operation sections of the specifications is not implied. Exposure to absolute maximum rating conditions for extended periods of time may affect reliability.

Power Supply, (V_{CC}).....	-0.3V to +6.0V
V+	-0.3V to +7.0V
V-	+0.3V to -7.0V
V+ + V- 	+13.0V
I_{CC} (DC V_{CC} or GND current).....	± 100 mA

Input Voltages

TxIN, SHUTDOWN, EN.....	-0.3V to +6.0V
RxIN.....	± 25 V

Output Voltages

TxOUT	± 12 V
RxOUT.....	-0.3V to (V_{CC} +0.3V)

Short-Circuit Duration

TxOUT	Continuous
Operating Temperature.....	-40°C to +85°C
Storage Temperature.....	-65°C to +150°C

Power Dissipation Per Package

24-pin SSOP (derate 8.00mW/°C above +70°C)....	640mW
24-pin WSOIC (derate 11.76mW/°C above +70°C)	941mW
28-pin SSOP (derate 9.52mW/°C above +70°C)...	762mW
28-pin WSOIC (derate 12.50mW/°C above +70°C)	1W

Storage Considerations

Storage in a low humidity environment is preferred. Large high density plastic packages are moisture sensitive and should be stored in Dry Vapor Barrier Bags. Prior to usage, the parts should remain bagged and stored below 40°C and 60%RH. If the parts are removed from the bag, they should be used within 48 hours or stored in an environment at or below 20%RH. If the above conditions cannot be followed, the parts should be baked for four hours at 125°C in order to remove moisture prior to soldering. Zywyn ships product in Dry Vapor Barrier Bags with a humidity indicator card and desiccant pack. The humidity indicator should be below 30%RH.

The information furnished by Zywyn has been carefully reviewed for accuracy and reliability. Its application or use, however, is solely the responsibility of the user. No responsibility of the use of this information become part of the terms and conditions of any subsequent sales agreement with Zywyn. Specifications are subject to change without the responsibility for any infringement of patents or other rights of third parties which may result from its use. No license or proprietary rights are granted by implication or otherwise under any patent or patent rights of Zywyn Corporation.

Electrical Characteristics

Unless otherwise stated, $V_{CC} = +5.0V$, $T_A = T_{min}$ to T_{max} , C1 to C4 = 0.1 μ F, typical values apply at $V_{CC} = +5.0V$ and $T_A = 25^\circ C$.

Parameter	Condition	Min	Typ	Max	Units
TTL Logic Input TTL Logic Output RS-232 Input RS-232 Output Charge Pump Pin Power Pin	$T_1IN, T_2IN, T_3IN, T_4IN, T_5IN, \overline{EN}, \overline{SD}$ $R_1OUT, R_2OUT, R_3OUT, R_4OUT, R_5OUT$ $R_1IN, R_2IN, R_3IN, R_4IN, R_5IN$ $T_1OUT, T_2OUT, T_3OUT, T_4OUT, T_5OUT$ C_1P, C_1N, C_2P, C_2N $V_{CC}, V_{GND}, V_{DD}, V_{SS}$	see specifications below			
Charge Pump Caps Temp 0°C to +70°C Temp -40°C to +85°C V_{CC} Voltage Range	C_1P, C_1N, C_2P, C_2N Commercial Grade Industrial Grade $V_{CC} = +5.0V$ Supply	0.1 0 -40 4.5	0.1 +25 +25 5	1.0 +70 +85 5.5	μ F °C °C V
Supply Current	TTL Inputs = V_{CC}/GND , RS-232 Input = float, $T_A = 25^\circ C$ $V_{CC} = +5.0V \pm 10\%$, No load on transmitter outputs		3	6	mA
Supply Current Transmitters Loaded	TTL Inputs = V_{CC}/GND , RS-232 Inputs = float, $T_A = 25^\circ C$ $V_{CC} = +5.0V$, All transmitter outputs loaded with $R_L = 3k\Omega$		15		mA
Supply Current, SHUTDOWN Enabled	$\overline{SD} = GND$, TTL Inputs = V_{CC}/GND , $T_A = 25^\circ C$ RS-232 Inputs = float, $V_{CC} = +5.0V$		1	10	μ A
TTL LOGIC Input Input Threshold Low Input Threshold High Input Hysteresis Input Leakage Current Input Leakage Current	$V_{CC} = +5.0V$ Supply $V_{IN} = V_{CC}$ and GND, $T_xIN, \overline{EN}, \overline{SD}$ $V_{IN} = V_{CC}$ and GND, T_xIN	2.4	0.5 ± 0.01 50	0.8 ±1 200	V V V μ A μ A
TTL LOGIC Output Output Voltage Low Output Voltage High Output Leakage Current	$I_{OUT} = 1.6mA$ $I_{OUT} = -1.0mA$ Receiver Outputs Disabled, $V_{OUT} = V_{CC}$ or GND, $\overline{SD} = GND, \overline{EN} = V_{CC}$	$V_{CC}-0.6$	$V_{CC}-0.1$ ± 0.05	0.4 ±10	V V μ A
Receiver Input Input Voltage Range Input Threshold Low Input Threshold High Input Hysteresis Input Resistance	$T_A = T_{min} - T_{max}$ $T_A = 25^\circ C, V_{CC} = 5.0V$ $V_{CC} = +5.0V$ Supply $T_A = 25^\circ C$ $V_{IN} = \pm 25V, T_A = 25^\circ C$	-25 0.8 3	1.5 0.5	25 2.4 7	V V V V k Ω
Transmitter Output Output Voltage Swing Output Resistance Output Short-Circuit Current Output Leakage Current	$R_L = 3k\Omega$, All Outputs are loaded $V_{CC} = V_{DD} = V_{SS} = GND, V_{OUT} = \pm 2V$ $V_{OUT} = GND$ Transmitter Disabled, $V_{OUT} = \pm 12V$	± 5 300	 ± 5	 ±60	V Ω mA μ A

Electrical Characteristics

Unless otherwise stated, $V_{CC} = +5.0V$, $T_A = T_{min}$ to T_{max} , $C1$ to $C4 = 0.1\mu F$, typical values apply at $V_{CC} = +5.0V$ and $T_A = 25^\circ C$.

Parameter	Condition	Min	Typ	Max	Units
Timing Characteristics					
Maximum Data Rate One Transmitter Switching,	$R_L = 3k\Omega$, $C_L = 250pF$, $T_A = 25^\circ C$ Refers to Figure 1 and 2.	1000			kbps
Transition-Region Slew Rate	$R_L = 3\sim 7k\Omega$, $C_L = 150pF$ to $250pF$, One Transmitter Switching, $T_A = 25^\circ C$, Measured from $+3V$ to $-3V$ or $-3V$ to $+3V$.		90		$V/\mu s$
Transmitter Propagation t_{PLH} Transmitter Propagation t_{PHL} Transmitter Output Enable Time Transmitter Output Disable Time	All transmitters loaded with $R_L = 3k\Omega$, $C_L = 1000pF$ All transmitters loaded with $R_L = 3k\Omega$, $C_L = 1000pF$		1.5 1.5 0.4 0.25		μs μs μs μs
Receiver Propagation t_{PLH} Receiver Propagation t_{PHL} Receiver Skew Receiver Output Enable Time Receiver Output Disable Time	$C_L = 150pF$ $C_L = 150pF$ $t_{PHL} - t_{PLH}$		0.15 0.15 50 0.2 0.2		μs μs ns μs μs
ESD Tolerance					
<u>RS-232 I/Os</u> ESD HBM			± 15		kV
<u>TTL/CMOS I/Os</u> ESD HBM			± 2		kV

SD	EN	ZT213F Only		Power Up/Down	Receiver Outputs
		SD	EN		
0	0	1	1	Up	Enable
0	1	1	0	Up	Tri-State
1	0	0	1	Down	Enable
1	1	0	0	Down	Tri-State

Table 1. Wake-Up Truth Table for ZT213F

Circuit Description

Proprietary Switch-Capacitor Regulated Voltage Converter

Different from other suppliers, Zywyn uses a patent pending switch-capacitor voltage-controlled source and sink current generators design to provide powerful bipolar voltages to maintain compliant EIA/RS232 levels regardless of power supply fluctuations. The design consists of an internal regulated oscillator, a two phase clock cycling, regulated complementary MOS switches, fast switching diode and switch capacitors.

The switch capacitor bi-directional current generators operate with Zywyn's proprietary smartly regulated complementary MOS switches and fast switching diode from its proprietary high voltage process technology. The efficiency of these bi-directional current generators is well over 70%. The switching frequency is generated by an internal oscillator and regulated by the current loads. The switch capacitor pump design delivers higher negative bucked voltage than the positive boosted voltage to achieve a balanced voltage controlled source and sink current generators resulting a balanced bipolar voltage supplies to the chip.

With its unique proprietary design technique, Zywyn's interface product series provide a better power efficient, stable and compliant EIA/RS232 levels with superior low power consumption.

Controlled Enable and Power-Down

The ZT211F and ZT213F both feature an enable input, which allows the receiver outputs to be either tri-stated or enabled. This can be especially useful when the receiver is tied directly to a microprocessor data bus. For the ZT211F, enable is active low, in which a logic LOW applied to the EN pin will enable the receiver outputs. For the ZT213F, enable is active high in which a logic HIGH applied to the EN pin will enable the receiver outputs.

ZT211F and ZT213F have a low-power shutdown mode controlled by the SD pin. During shutdown the driver output and the switch-capacitor regulated voltage converter are disabled with the supply current falls to less than 1 μ A.

ZT213F includes a wakeup function (see Table 1) that enables two receivers during a shutdown state. With only the receivers active during the shutdown state, the devices draw 5-10 μ A of supply current. A typical application is when a RS232 cable is connected or when the peripheral is enabled such as a modem, the devices will automatically become active again. The ring indicator signal from the modem could be passed through an active receiver in the ZT213F that is itself in the shutdown mode. The ring indicator signal would propagate through the ZT213F to the power management circuitry of the computer to power up the microprocessor and the ZT213F drivers. After the supply voltage to the ZT213F reaches +5.0V, the SD pin can be disabled, taking the ZT213F out of the shutdown mode. All receivers that are active during shutdown maintain 500mV (typ.) of hysteresis.

ESD Immunity

Electro-Static Discharge (ESD) is an important factor when implementing a serial port into a system. In some applications, it is crucial that the ESD protection for the system must meet a certain tolerance level. Since RS232 transceiver devices are exposed to the outside world, there are many environmental factors that can effect the serial port and even subject it to transients that could potentially damage the transceiver itself.

The RS232 transceiver is usually routed from the serial port connector to the transceiver IC through the metal trace on the printed circuit board. This trace will have some small amount of resistance that will add some protection in terms of limiting transient current to the IC. However for added voltage protection, transient voltage suppressors (TVS) or transzorb, which are back-to-back diode arrays clamp, are usually necessary to protect the serial port circuitry.

To further reduce cost within their system, more engineers are requiring higher ESD tolerances from the transceiver ICs themselves without having to add costly TVS circuitry. Zywyn's RS232 transceivers includes built-in transient voltage suppression where external ESD circuitry is not necessary to meet the MIL-STD-883, Method 3015, Human Body Model and the EN61000-4-2 Air/Contact Discharge tests.

The Human Body Model has been the generally accepted ESD testing method for semiconductors. This test is intended to simulate the human body's potential to store electrostatic energy and discharge it to an integrated circuit upon close proximity or contact. This method will test the IC's capability to withstand an ESD transient during normal handling such as in manufacturing areas where the ICs tend to be handled frequently.

EN61000-4-2 is used for testing ESD on equipment and systems. For system manufacturers, they must guarantee a certain amount of ESD protection since the system itself is exposed to the outside environment and human presence. EN61000-4-2 specifies that the system is required to withstand an amount of static electricity when ESD is applied to exposed metal points and surfaces of the equipment that are accessible to personnel during normal usage. The transceiver IC receives most of the ESD current when the ESD source is applied to the connector pins.

There are two methods within EN61000-4-2, the Air Discharge method and the Contact Discharge method. With the Air Discharge Method, an ESD voltage is applied to the equipment under test through air, which simulates an electrically charged person ready to connect a cable onto the rear of the system and the high energy potential on the person discharges through an arcing path to the rear panel of the system before he or she even touches the system. The Contact Discharge Method applies the ESD current directly to the EUT. This method was devised to reduce the unpredictability of the ESD arc. The discharge current rise time is constant since the energy is directly transferred without the air-gap arc inconsistencies.

RS232 Signal Characteristics

The charge pump voltage converter efficiently converts the necessary voltage for the driver's output transistors so that the RS232 output is close to the ideal rail voltage of 10V.

While loaded with a typical RS232 load, the driver's output level only drops 0.2V from its open circuit voltage. Zywyn's low-drop driver circuitry working with its efficient voltage regulator allows superior line driving capability while meeting the requirements of TIA/EIA-232-E.

The drivers are inverting transmitters, which accept TTL or CMOS inputs and produces the RS-232 compliant signals that is inverted relative to the input logic levels. Typically the RS232 output voltage swing is $\pm 6V$. Even under the worst case loading conditions of 3kohms and 2500pF, the output is guaranteed to be $\pm 5V$, which adheres to the RS232 standard specifications. The transmitter outputs are protected against infinite short-circuits to ground without degradation in reliability. The instantaneous slew rate of the transmitter output is internally limited to a maximum of $30V/\mu s$ in order to meet the TIA/EIA-232-E requirements.

The receivers convert RS-232 input signals to inverted TTL signals. The inputs have a typical hysteresis margin of 500mV in order to account for signal degradation caused by system interference and other noise related disturbers. This ensures that the receiver is relatively immune to noisy transmission lines. The input thresholds are 0.8V minimum and 2.4V maximum, which are within the TIA/EIA-232 requirements. The receiver inputs are also protected against voltages up to $\pm 25V$. Should an input be left unconnected, a 5kohm pull-down resistor to ground will force the output of the receiver to a high state.

Specification	RS-232D	RS-423A	RS-422	RS-485	RS-562
Mode of Operation	Single-Ended	Single-Ended	Differential	Differential	Single-Ended
No. of Drivers and Receivers Allowed on One Line	1 Driver 1 Receiver	1 Driver 10 Receivers	1 Driver 10 Receivers	32 Drivers 32 Receivers	1 Driver 1 Receiver
Maximum Cable Length	50 feet	4,000 feet	4,000 feet	4,000 feet	$C \leq 2,500 \text{ pF@ } <20\text{kbps}$; $C \leq 1,000 \text{ pF@ } >20\text{kbps}$
Maximum Data Rate	20 kbps	100 kbps	10 Mbps	10 Mbps	64 kbps
Driver Output Maximum Voltage	$\pm 25V$	$\pm 6V$	- 0.25V to +6V	- 7V to +12V	- 3.7V to +13.2V
Driver Output Signal Level					
Loaded	$\pm 5V$	$\pm 3.6V$	$\pm 2V$	$\pm 1.5V$	$\pm 3.7V$
Unloaded	$\pm 15V$	$\pm 6V$	$\pm 5V$	$\pm 5V$	$\pm 13.2V$
Driver Load Impedance	3 ~ 7K Ω	450 Ω	100 Ω	54 Ω	3 ~ 7K Ω
Maximum Driver Output Current (High Impedance State)					
Power On				$\pm 100\mu A$	
Power Off	$V_{MAX}/300$	100 μA	$\pm 100\mu A$	$\pm 100\mu A$	
Slew Rate	30V/ μs max.	Controls Provided			30V/ μs max.
Receiver Input Voltage Range	$\pm 15V$	$\pm 12V$	-7V to +7V	-7V to +12V	$\pm 15V$
Receiver Input Sensitivity	$\pm 3V$	$\pm 200mV$	$\pm 200mV$	$\pm 200mV$	$\pm 3V$
Receiver Input Resistivity	3 ~ 7K Ω	4K Ω min.	4K Ω min.	12K Ω min.	3 ~ 7K Ω

Table 2. EIA Standard Parameter Summary

Pin Configuration

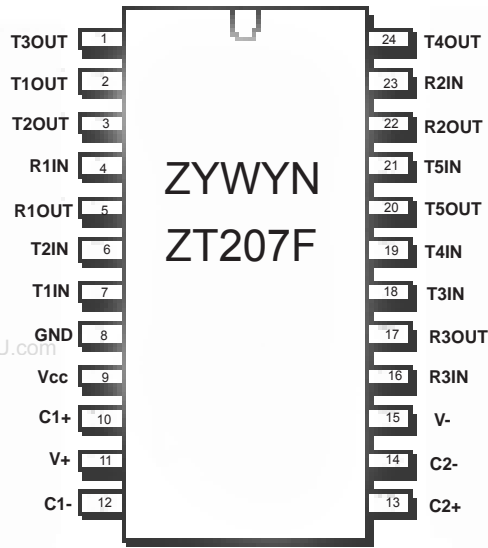

24-pin SSOP/PDIP/WSOIC

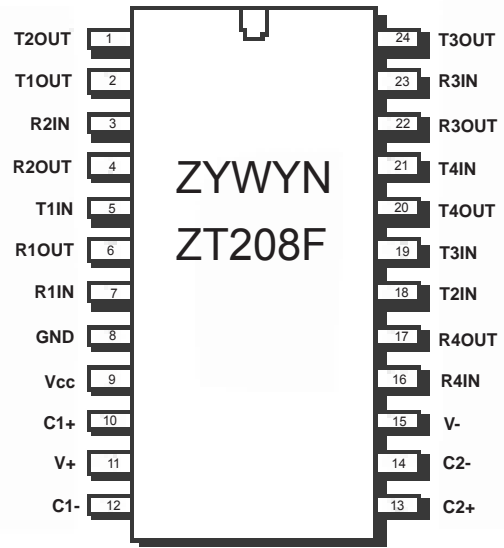

24-pin SSOP/PDIP/WSOIC

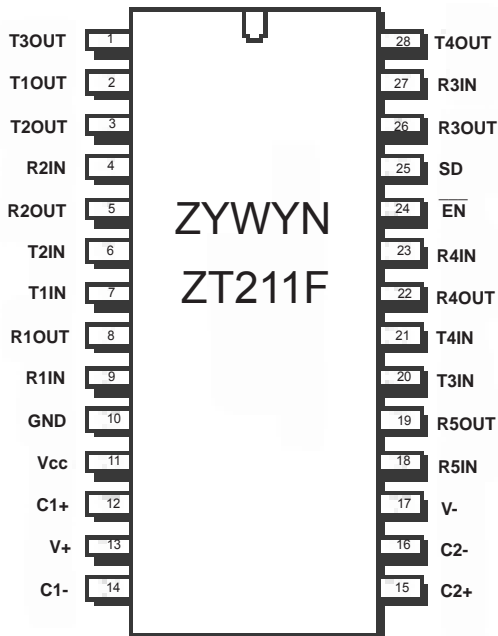

28-pin SSOP/WSOIC

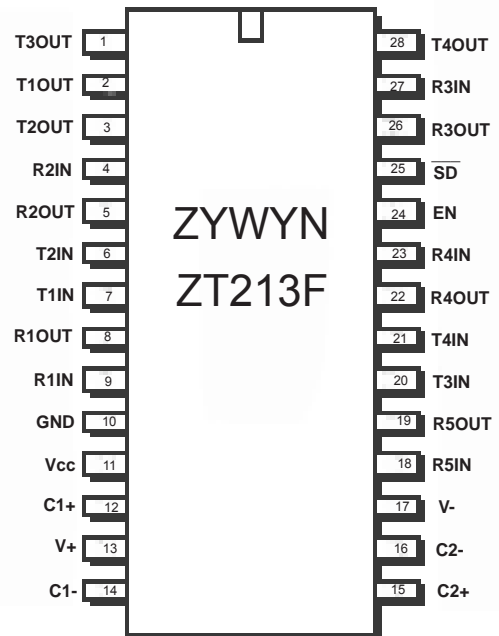

28-pin SSOP/WSOIC

Typical Application Circuits

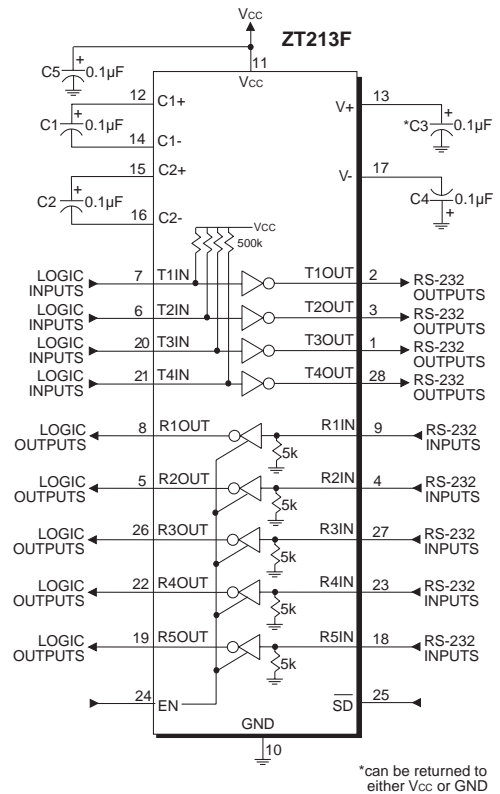
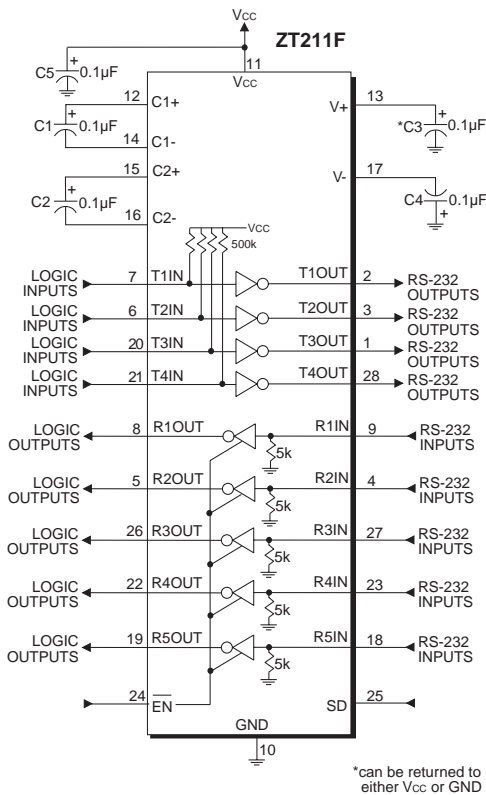
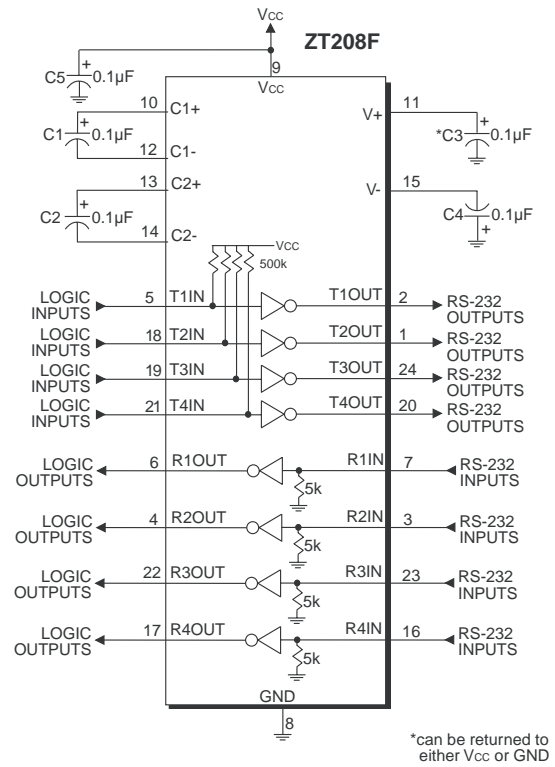
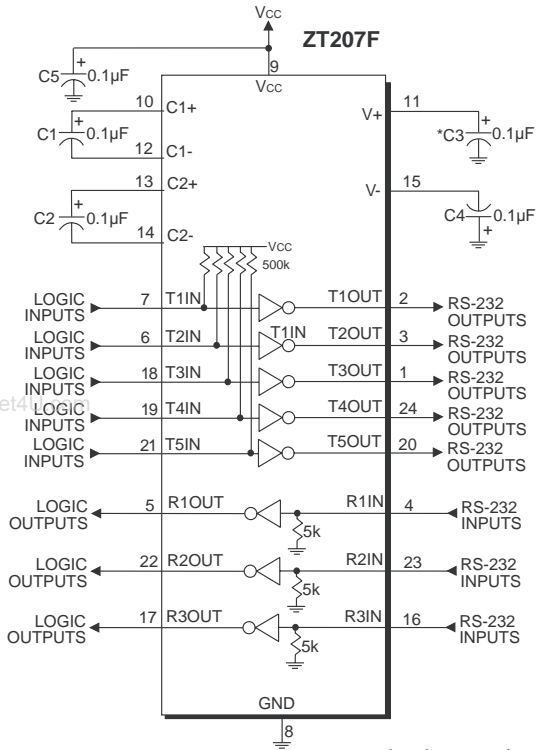

Typical Test Circuits

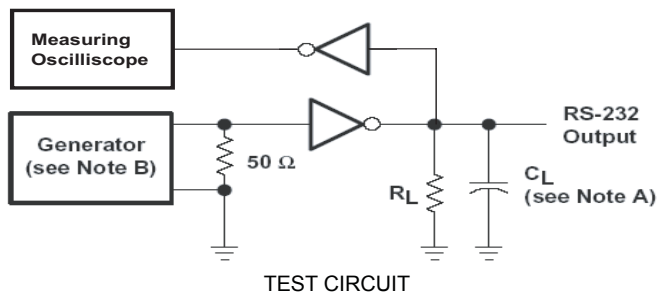

Maximum Data Rate Test Circuit

Notes:

A. $R_L = 3k\Omega$, $C_L = 250pF$, $T_A = 25^\circ C$,
One Driver Switching.

B. The pulse generator had the following characteristics:
PRR = 1000 kbps, $Z_o = 50\Omega$, 50% duty cycle,
 T_r & $T_f \leq 10ns$

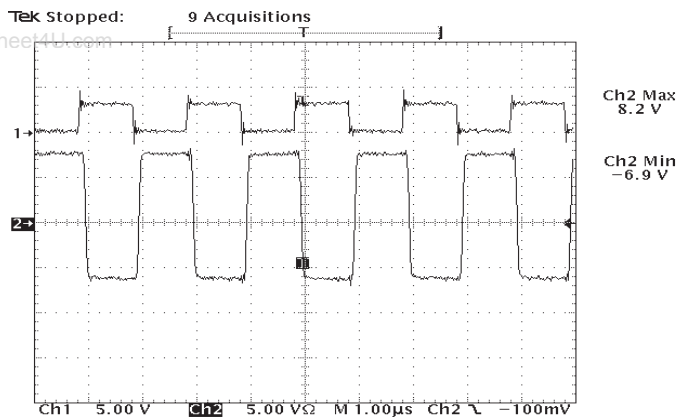

Figure 1. ZT230F TxIN to TxOut (no load) at 1Mbps waveform

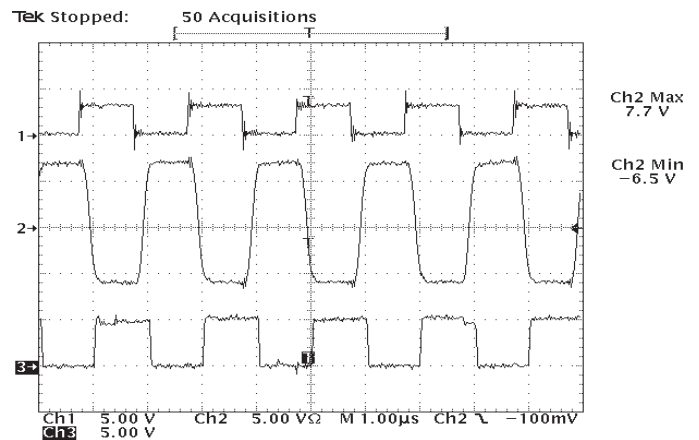

Figure 2. ZT230F TxIN to TxOut to RxOut (loopback to Rx with 250pF load) at 1Mbps waveform

Test Circuit RS232 Signal Characteristics

Figure 1 shows the normal RS232 transceiver function with a TTL/CMOS signal applied to the input on channel 1 and the resultant RS232 output shown on channel 2. This figure shows a typical RS232 line driver output without loading. In other words, this is the open circuit RS232 output voltage. The charge pump voltage converter efficiently converts the necessary voltage for the driver's output transistors so that the RS232 output is close to the ideal rail voltage of 6.6V.

Figure 2 shows the RS232 transceiver function using the TTL/CMOS input on channel 1 while showing the RS232 output on channel 2. This figure shows the RS232 signal while the output is loaded with 3kohms and 250pF. The resistive load is the receiver's input impedance as the driver's output is looped back to the receiver's input. The resultant output

on channel 3 is the receiver's TTL/CMOS output. While loaded with a typical RS232 load, the driver's output level only drops 0.2V from its open circuit voltage while running at 1Mbps. The RS-232 output on channel 2 also shows good signal integrity while at the high data rates, which allows the receiver to process the signal with minimum skew and delay. Zywyn's low-drop driver circuitry working with its efficient voltage regulator allows superior line driving capability with the bonus of $\pm 15kV$ ESD immunity.

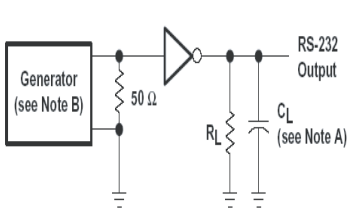

TEST CIRCUIT

$$SR(tr) = \frac{6V}{t_{PHL(D)} \text{ or } t_{PLH(D)}}$$

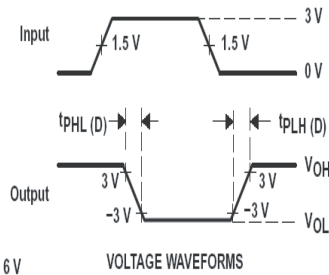

VOLTAGE WAVEFORMS

Driver Transition-Region Slew Rate Test Circuit

Notes:

A. $R_L = 3k\sim 7k\Omega$, $C_L = 150pF$ to $250pF$,

One Driver Switching, $T_A = 25^\circ C$,

Measured from +3V to -3V or -3V to +3V.

B. The pulse generator had the following characteristics:

PRR = 1000 kbps, $Z_o = 50\Omega$, 50% duty cycle,

T_r & $T_f \leq 10ns$

www.DataSheet4U.com

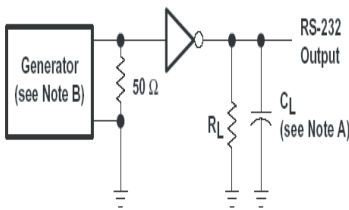

TEST CIRCUIT

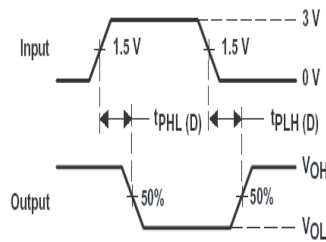

VOLTAGE WAVEFORMS

Driver Propagation (t_{PHL} & t_{PLH}) Test Circuit

Notes:

A. All drivers loaded with $R_L = 3k\Omega$, $C_L = 1000pF$.

B. The pulse generator had the following characteristics:

PRR = 1000 kbps, $Z_o = 50\Omega$, 50% duty cycle,

T_r & $T_f \leq 10ns$

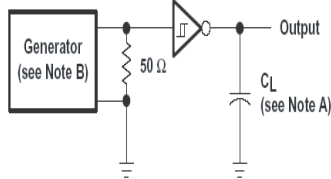

TEST CIRCUIT

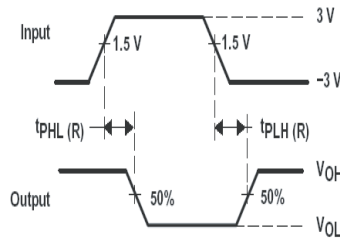

VOLTAGE WAVEFORMS

Receiver Propagation Delay Times Test Circuit

Notes:

A. $C_L = 150pF$, including probe and jig capacitance.

B. The pulse generator had the following characteristics:

PRR = 1000 kbps, $Z_o = 50\Omega$, 50% duty cycle,

T_r & $T_f \leq 10ns$

Package Information

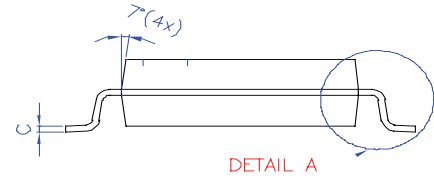
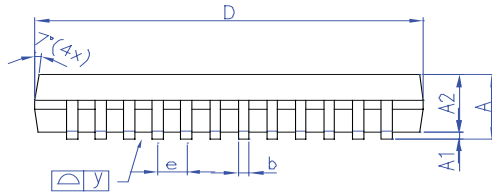
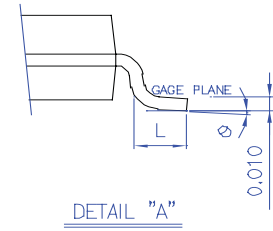
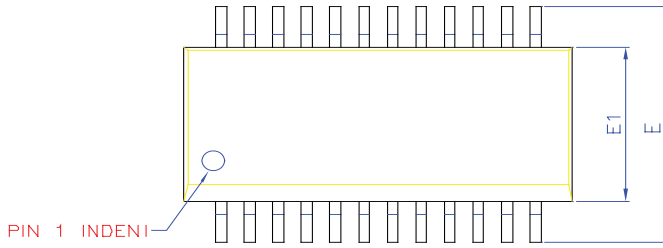

NOTE :

- CONTROLLING DIMENSION : INCH
- LEAD FRAME MATERIAL : COPPER 194
- DIMENSION "D" DOES NOT INCLUDE MOLD FLASH, THE BAR BURRS AND GATE BURRS. MOLD FLASH, THE BAR BURRS AND GATE BURRS SHALL NOT EXCEED 0.006[0.15mm] PER END DIMENSION "E1" DOES NOT INCLUDE INTERLEAD FLASH. INTERLEAD FLASH SHALL NOT EXCEED 0.010[0.25mm] PER SIDE.
- DIMENSION "b" DOES NOT INCLUDE DAMBAR PROTRUSION. ALLOWABLE DAMBAR PROTRUSION SHALL BE 0.003[0.08mm] TOTAL IN EXCESS OF THE "b" DIMENSION AT MAXIMUM MATERIAL CONDITION. DAMBAR CANNOT BE LOCATED ON THE LOWER RADIUS OR THE FOOT. MINIMUM SPACE BETWEEN PROTRUSION AND AN ADJACENT LEAD TO BE 0.0028[0.07mm]
- TOLERANCE : ±0.010[0.25mm] UNLESS OTHERWISE SPECIFIED.
- OTHERWISE DIMENSION FOLLOW ACCEPTABLE SPEC.
- REFERENCE DOCUMENT : JEDEC SPEC MO-137

SYMBOLS	DIMENSIONS IN MILLIMETERS			DIMENSIONS IN INCHES		
	MIN	NOM	MAX	MIN	NOM	MAX
A	1.73	—	1.99	0.068	—	0.079
A1	0.05	—	0.21	0.002	—	0.008
A2	—	1.75	—	—	0.069	—
b	0.22	0.30	0.38	0.0086	0.012	0.015
C	0.13	0.15	0.20	0.0051	0.006	0.0079
D	8.07	—	8.33	0.317	—	0.328
E	7.40	7.80	8.20	0.291	0.307	0.323
E1	5.00	5.30	5.60	0.197	0.209	0.220
e	—	0.65	—	—	0.0256	—
L	0.56	0.75	0.97	0.022	0.030	0.037
y	—	—	0.076	—	—	0.003
φ	0"	—	8"	0"	—	8"

24-pin SSOP

CUSTOMER		ZYWYN CORPORATION	
APPROVED BY	DATE	TITLE:	
DRAW BY: Monica Chen	11/02/09	24L (.209") BODY .025" LEAD PITCH	
CHECK BY: Paul Lee	11/02/09	SMALL OUTLINE PACKAGE DRAWING	
APPROVAL: Paul Lee	11/02/09	DWG. NO. PO-SSOP-002	REV. 0
APPROVAL: Jack Su	11/02/09	UNIT : INCH	SCALE 12/1 SHEET 1 OF 1

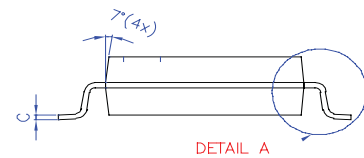
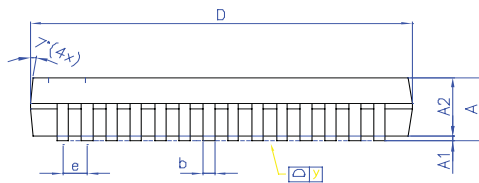
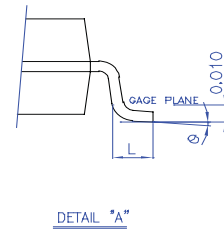
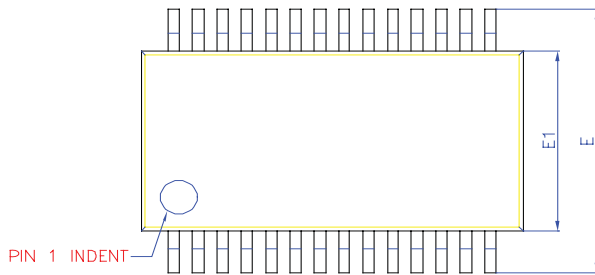

NOTE :

- CONTROLLING DIMENSION : mm
- LEAD FRAME MATERIAL : COPPER 194
- DIMENSION "D" DOES NOT INCLUDE MOLD FLASH, THE BAR BURRS AND GATE BURRS. MOLD FLASH, THE BAR BURRS AND GATE BURRS SHALL NOT EXCEED 0.006[0.15mm] PER END DIMENSION "E1" DOES NOT INCLUDE INTERLEAD FLASH. INTERLEAD FLASH SHALL NOT EXCEED 0.010[0.25mm] PER SIDE.
- DIMENSION "b" DOES NOT INCLUDE DAMBAR PROTRUSION. ALLOWABLE DAMBAR PROTRUSION SHALL BE 0.003[0.08mm] TOTAL IN EXCESS OF THE "b" DIMENSION AT MAXIMUM MATERIAL CONDITION. DAMBAR CANNOT BE LOCATED ON THE LOWER RADIUS OR THE FOOT. MINIMUM SPACE BETWEEN PROTRUSION AND AN ADJACENT LEAD TO BE 0.0028[0.07mm]
- TOLERANCE : ±0.010[0.25mm] UNLESS OTHERWISE SPECIFIED.
- OTHERWISE DIMENSION FOLLOW ACCEPTABLE SPEC.
- REFERENCE DOCUMENT : JEDEC SPEC MO-150

SYMBOLS	DIMENSIONS IN MILLIMETERS			DIMENSIONS IN INCHES		
	MIN	NOM	MAX	MIN	NOM	MAX
A	—	—	2.00	—	—	0.079
A1	0.05	—	—	0.002	—	—
A2	—	1.75	—	—	0.069	—
b	0.22	0.30	0.38	0.0086	0.012	0.015
C	0.13	0.15	0.20	0.0051	0.006	0.0079
D	10.08	10.20	10.34	0.397	0.402	0.407
E	7.40	7.80	8.20	0.291	0.307	0.323
E1	5.00	5.30	5.60	0.197	0.209	0.220
e	—	0.65	—	—	0.0256	—
L	0.56	0.75	0.97	0.022	0.030	0.037
φ	—	4"	8"	—	4"	8"
y	—	—	0.076	—	—	0.003

28-pin SSOP

CUSTOMER :		ZYWYN CORPORATION	
APPROVED BY	DATE	TITLE:	
DRAW BY: Monica Chen	10/11/09	28L (.209") BODY .025" LEAD PITCH	
CHECK BY: Paul Lee	11/01/09	SMALL OUTLINE PACKAGE DRAWING	
APPROVAL: Paul Lee	11/01/09	DWG. NO. PO-SSOP-011	REV. 0
APPROVAL: Jack Su	11/01/09	UNIT : mm	SCALE : 10/1 SHEET 1 OF 1



BOTTOM E-PIN INDENT $\phi 0.125$ NOTE 8

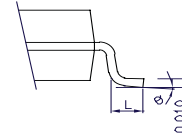
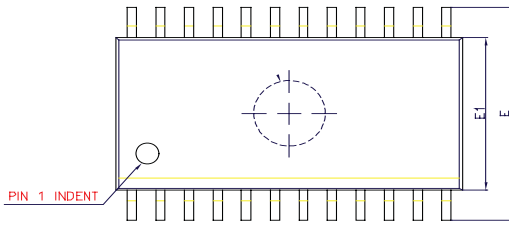

view "A"

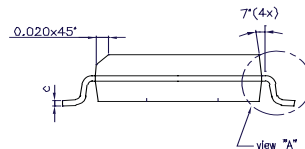
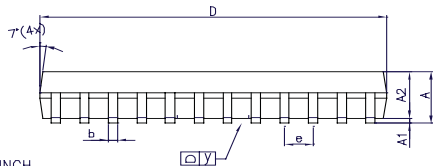

view "A"

NOTE :

1. CONTROLLING DIMENSION : INCH
2. LEAD FRAME MATERIAL : COPPER 194
3. DIMENSION "D" DOES NOT INCLUDE MOLD FLASH, TIE BAR BURRS AND GATE BURRS. MOLD FLASH, TIE BAR BURRS AND GATE BURRS SHALL NOT EXCEED 0.006"[0.15mm] PER END DIMENSION "E1" DOES NOT INCLUDE INTERLEAD FLASH. INTERLEAD FLASH SHALL NOT EXCEED 0.010"[0.25mm] PER SIDE.
4. DIMENSION "b" DOES NOT INCLUDE DAMBAR PROTRUSION. ALLOWABLE DAMBAR PROTRUSION SHALL BE 0.003"[0.08mm] TOTAL IN EXCESS OF THE "b" DIMENSION AT MAXIMUM MATERIAL CONDITION. DAMBAR CANNOT BE LOCATED ON THE LOWER RADIUS OR THE FOOT. MINIMUM SPACE BETWEEN PROTRUSION AND AN ADJACENT LEAD TO BE 0.0028"[0.07mm]
5. TOLERANCE : ± 0.010 "[0.25mm] UNLESS OTHERWISE SPECIFIED.
6. OTHERWISE DIMENSION FOLLOW ACCEPTABLE SPEC.
7. REFERENCE DOCUMENT : JEDEC SPEC MS-013
8. BOTTOM E-PIN INDENT IN MARKED AS BELOW :



X : A ~ M
Y : 1 ~ 14

SYMBOLS	DIMENSIONS IN MILLIMETERS			DIMENSIONS IN INCHES		
	MIN	NOM	MAX	MIN	NOM	MAX
A	2.36	2.49	2.64	0.093	0.098	0.104
A1	0.10	—	0.30	0.004	—	0.012
A2	—	2.34	—	—	0.092	—
b	0.33	0.41	0.51	0.013	0.016	0.020
c	0.23	0.25	0.30	0.009	0.010	0.012
D	15.19	15.39	15.49	0.598	0.606	0.610
E	10.01	10.31	10.64	0.394	0.406	0.419
E1	7.39	7.49	7.59	0.291	0.295	0.299
e	—	1.27	—	—	0.050	—
L	0.38	0.81	1.27	0.015	0.032	0.050
y	—	—	0.076	—	—	0.003
Ø	0"	—	8"	0"	—	8"

24-pin wSOIC

CUSTOMER :		ZYWYN CORPORATION	
APPROVED BY	DATE	TITLE:	
DRAW BY: Monica Chen	10/28/98	24L WIDE BODY SMALL OUTLINE PACKAGE DRAWING	
CHECK BY: Leo Chen	11/01/98	DWG. NO. PO-SOP-007	REV. 0
APPROVAL: Paul Leu	11/02/98	UNIT :	SCALE : 6/1
APPROVAL: Jack Tu	11/02/98	INCH	SHEET 1 OF 1

BOTTOM E-PIN INDENT $\phi 0.125$ NOTE 8

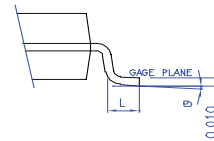
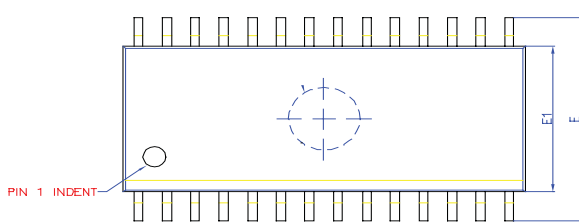

view "A"

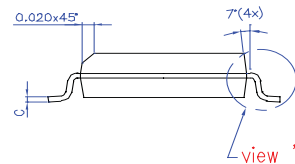
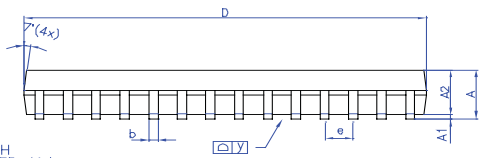

view "A"

NOTE :

1. CONTROLLING DIMENSION : INCH
2. LEAD FRAME MATERIAL : COPPER 194
3. DIMENSION "D" DOES NOT INCLUDE MOLD FLASH, TIE BAR BURRS AND GATE BURRS. MOLD FLASH, TIE BAR BURRS AND GATE BURRS SHALL NOT EXCEED 0.006"[0.15mm] PER END DIMENSION "E1" DOES NOT INCLUDE INTERLEAD FLASH. INTERLEAD FLASH SHALL NOT EXCEED 0.010"[0.25mm] PER SIDE.
4. DIMENSION "b" DOES NOT INCLUDE DAMBAR PROTRUSION. ALLOWABLE DAMBAR PROTRUSION SHALL BE 0.003"[0.08mm] TOTAL IN EXCESS OF THE "b" DIMENSION AT MAXIMUM MATERIAL CONDITION. DAMBAR CANNOT BE LOCATED ON THE LOWER RADIUS OR THE FOOT. MINIMUM SPACE BETWEEN PROTRUSION AND AN ADJACENT LEAD TO BE 0.0028"[0.07mm]
5. TOLERANCE : ± 0.010 "[0.25mm] UNLESS OTHERWISE SPECIFIED.
6. OTHERWISE DIMENSION FOLLOW ACCEPTABLE SPEC.
7. REFERENCE DOCUMENT : JEDEC SPEC MS-013
8. BOTTOM E-PIN INDENT IN MARKED AS BELOW :



X : A ~ M
Y : 1 ~ 12

SYMBOLS	DIMENSIONS IN MILLIMETERS			DIMENSIONS IN INCHES		
	MIN	NOM	MAX	MIN	NOM	MAX
A	2.36	2.49	2.64	0.093	0.098	0.104
A1	0.10	—	0.30	0.004	—	0.012
A2	—	2.34	—	—	0.092	—
b	0.33	0.41	0.51	0.013	0.016	0.020
c	0.23	0.25	0.30	0.009	0.010	0.012
D	17.70	17.91	18.11	0.697	0.705	0.713
E	10.01	10.31	10.64	0.394	0.406	0.419
E1	7.39	7.49	7.59	0.291	0.295	0.299
e	—	1.27	—	—	0.050	—
L	0.38	0.81	1.27	0.015	0.032	0.050
y	—	—	0.076	—	—	0.003
Ø	0"	—	8"	0"	—	8"

28-pin wSOIC

CUSTOMER :		ZYWYN CORPORATION	
APPROVED BY	DATE	TITLE:	
DRAW BY: Monica Chen	10/28/98	28L WIDE BODY SMALL OUTLINE PACKAGE DRAWING	
CHECK BY: Leo Chen	11/01/98	DWG. NO. PO-SOP-008	REV. 0
APPROVAL: Paul Leu	11/02/98	UNIT :	SCALE : 6/1
APPROVAL: Jack Tu	11/02/98	INCH	SHEET 1 OF 1



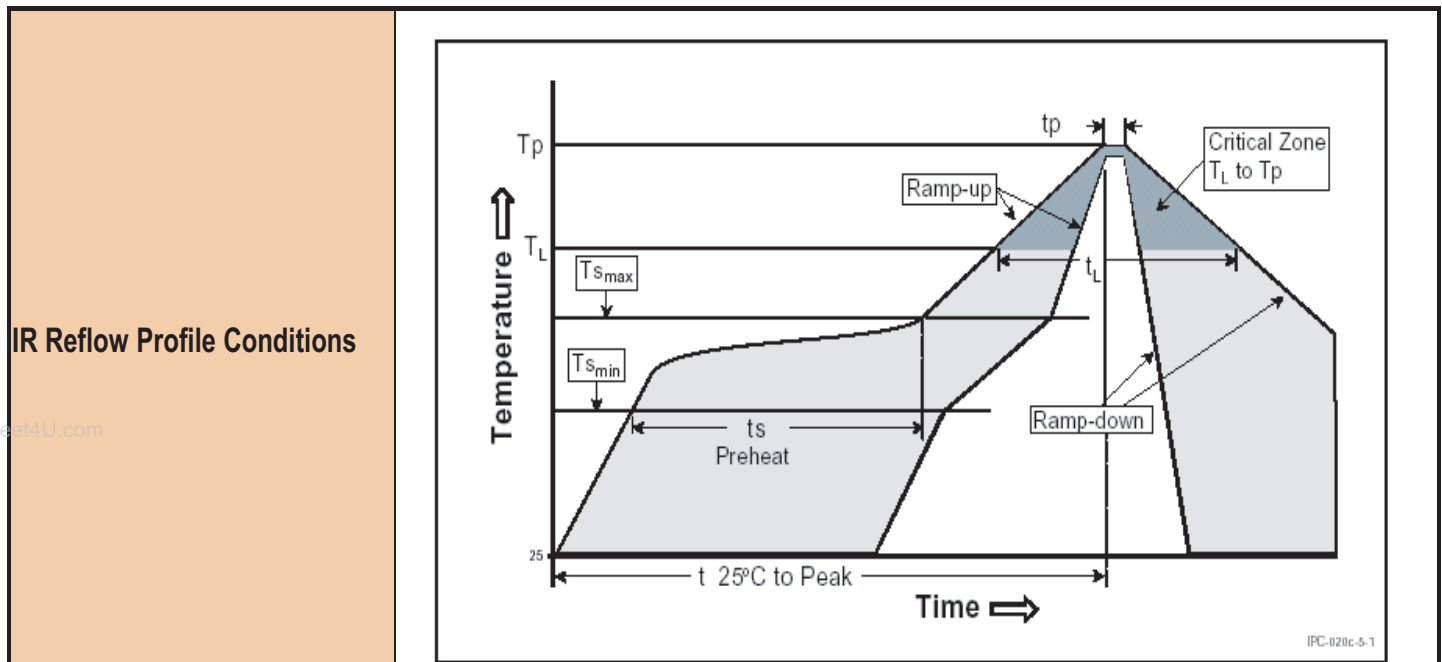





Green Package SMD IR Reflow Profile Information



Profile Feature	JESD Sn-Pb Eutectic Assembly	JESD Pb-free Assembly
Average Ramp-Up Rate (T _{Smax} to T _P)	3°C/seconds max.	3°C/seconds max.
Pre-heat		
- Temperature Min (T _{Smin})	100°C	150°C
- Temperature Max (T _{Smax})	150°C	200°C
- Time (T _{Smin} to t _{Smax})	60~120 seconds	60~180 seconds
Time maintained above:		
- Temperature (T _L)	183°C	217°C
- Time (t _L)	60~150 seconds	60~150 seconds
Peak/Classification Temperature (T _P)	235°C+5/-0°C	255°C+5/-0°C
Time within 5°C of actual Peak Temperature (t _p)	10~30 seconds	20~40 seconds
Ramp-Down Rate	6°C/second max.	6°C/second max.
Time 25°C to Peak Temperature	6 minutes max.	8 minutes max.

Zywyn Green Packages are Pb-free and RoHS compliance.

Ordering Information

Part Number	Drivers	Receivers	Temperature Range	Package Type	Green Package
ZT207FCA	5	3	0°C to +70°C	24-pin SSOP	
ZT207FCT	5	3	0°C to +70°C	24-pin WSOIC	
ZT208FCA	4	4	0°C to +70°C	24-pin SSOP	
ZT208FCT	4	4	0°C to +70°C	24-pin WSOIC	
ZT211FCA	4	5	0°C to +70°C	28-pin SSOP	
ZT211FCT	4	5	0°C to +70°C	28-pin WSOIC	
ZT213FCA	4	5 (2 active in SD)	0°C to +70°C	28-pin SSOP	
ZT213FCT	4	5 (2 active in SD)	0°C to +70°C	28-pin WSOIC	
ZT207FEA	5	3	-40°C to +85°C	24-pin SSOP	ZT207LFEA 
ZT207FET	5	3	-40°C to +85°C	24-pin WSOIC	ZT207LFET 
ZT208FEA	4	4	-40°C to +85°C	24-pin SSOP	ZT208LFEA 
ZT208FET	4	4	-40°C to +85°C	24-pin WSOIC	ZT208LFET 
ZT211FEA	4	5	-40°C to +85°C	28-pin SSOP	ZT211LFEA 
ZT211FET	4	5	-40°C to +85°C	28-pin WSOIC	ZT211LFET 
ZT213FEA	4	5 (2 active in SD)	-40°C to +85°C	28-pin SSOP	ZT213LFEA 
ZT213FET	4	5 (2 active in SD)	-40°C to +85°C	28-pin WSOIC	ZT213LFET 

Please contact the factory for pricing, availability on Tape-and-Reel, and **Green Package**  options.

Zywyn Corporation

Headquarters and Sales Office

1270 Oakmead Parkway, Suite 201 • Sunnyvale, CA 94085 • Tel: (408) 733-3225 • Fax: (408) 733-3206

Email: sales@zywyn.com • www.zywyn.com

Zywyn Corporation reserves the right to make changes to any products described herein. Zywyn does not assume any liability arising out of the application or use of any product or circuit described herein; neither does it convey any license under its patent rights nor the rights of others.

© 2006 Zywyn Corporation

