

# N-CHANNEL ENHANCEMENT MODE VERTICAL DMOS FET

## ZVN2106A

ISSUE 2 – MARCH 94

### FEATURES

- \* 60 Volt  $V_{DS}$
- \*  $R_{DS(on)}=2\Omega$

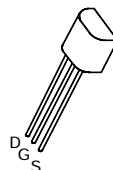

E-Line  
TO92 Compatible

### ABSOLUTE MAXIMUM RATINGS.

PARAMETER	SYMBOL	VALUE	UNIT
Drain-Source Voltage	$V_{DS}$	60	V
Continuous Drain Current at $T_{amb}=25^{\circ}C$	$I_D$	450	mA
Pulsed Drain Current	$I_{DM}$	8	A
Gate Source Voltage	$V_{GS}$	$\pm 20$	V
Power Dissipation at $T_{amb}=25^{\circ}C$	$P_{tot}$	700	mW
Operating and Storage Temperature Range	$T_j:T_{stg}$	-55 to +150	$^{\circ}C$

### ELECTRICAL CHARACTERISTICS (at $T_{amb} = 25^{\circ}C$ unless otherwise stated).

PARAMETER	SYMBOL	MIN.	MAX.	UNIT	CONDITIONS.
Drain-Source Breakdown Voltage	$BV_{DSS}$	60		V	$I_D=1mA, V_{GS}=0V$
Gate-Source Threshold Voltage	$V_{GS(th)}$	0.8	2.4	V	$I_D=1mA, V_{DS}=V_{GS}$
Gate-Body Leakage	$I_{GSS}$		20	nA	$V_{GS}=\pm 20V, V_{DS}=0V$
Zero Gate Voltage Drain Current	$I_{DSS}$		500 100	nA $\mu A$	$V_{DS}=60V, V_{GS}=0$ $V_{DS}=48V, V_{GS}=0V,$ $T=125^{\circ}C(2)$
On-State Drain Current(1)	$I_{D(on)}$	2		A	$V_{DS}=18V, V_{GS}=10V$
Static Drain-Source On-State Resistance (1)	$R_{DS(on)}$		2	$\Omega$	$V_{GS}=10V, I_D=1A$
Forward Transconductance (1)(2)	$g_{fs}$	300		mS	$V_{DS}=18V, I_D=1A$
Input Capacitance (2)	$C_{iss}$		75	pF	$V_{DS}=18V, V_{GS}=0V, f=1MHz$
Common Source Output Capacitance (2)	$C_{oss}$		45	pF	
Reverse Transfer Capacitance (2)	$C_{rss}$		20	pF	

# ZVN2106A

## TYPICAL CHARACTERISTICS

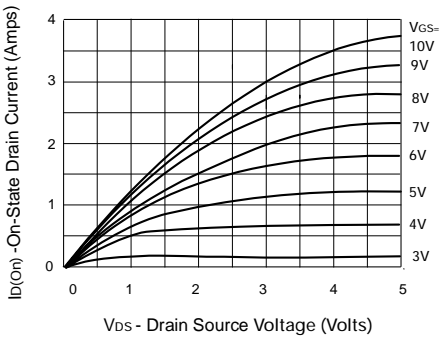

**Saturation Characteristics**

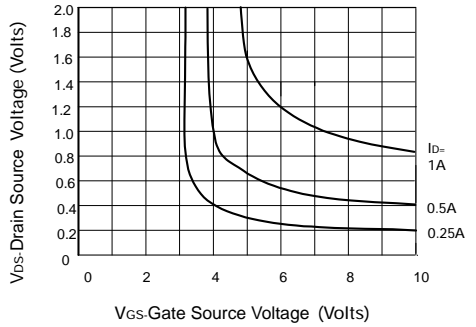

**Voltage Saturation Characteristics**

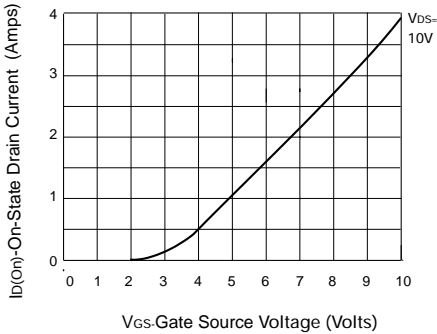

**Transfer Characteristics**

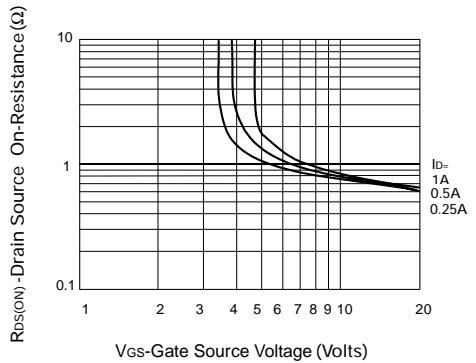

**On-resistance v gate-source voltage**

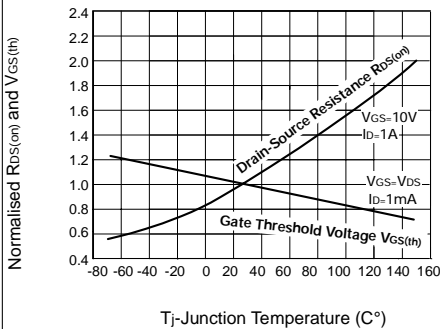

**Normalised  $R_{DS(on)}$  and  $V_{GS(th)}$  vs Temperature**

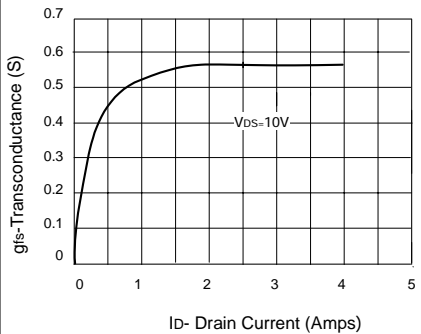

**Transconductance v drain current**

## TYPICAL CHARACTERISTICS

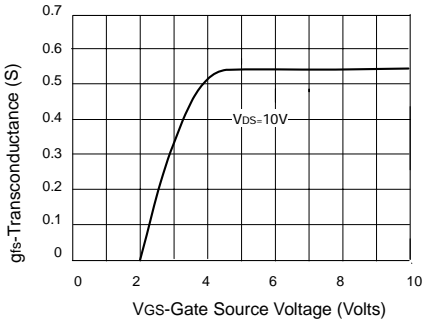

**Transconductance v gate-source voltage**

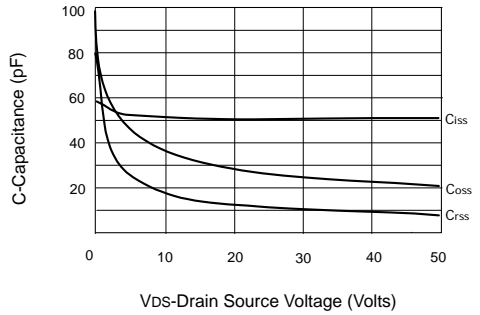

**Capacitance v drain-source voltage**

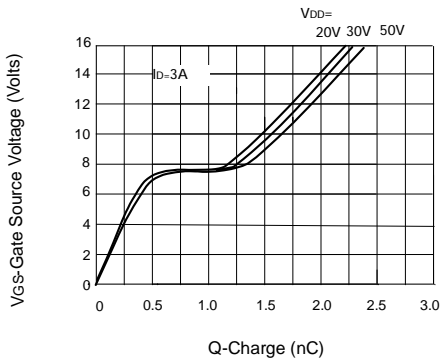

**Gate charge v gate-source voltage**