

Description

The iT3018 is a limiting amplifier for use as a post amplifier in OC-192 and STM-64 optical receivers. Differential signals as small as +/-6 mVpp can be amplified to 2.2 Vpp differential. The device includes offset correction and output voltage control. Both AC and DC coupling are allowed at both input and output. The high sensitivity of the iT3018 allows the device to be used at the output of a transimpedance amplifier.

Features

- ❖ 3 dB bandwidth: 10 GHz
- ❖ Differential gain: 50 dB
- ❖ Saturated output: 1.1 Vpp, each output into 50 ohm
- ❖ Input sensitivity 3.0 mVpp at BER<1E-12
- ❖ Single bias supply: -5.2 V
- ❖ Power consumption: 624 mW
- ❖ Bias current: 120 mA
- ❖ DC offset correction
- ❖ Amplitude Voltage Control
- ❖ Low RMS Jitter
- ❖ Low-cost JEDEC QFP-N (MO-220) package

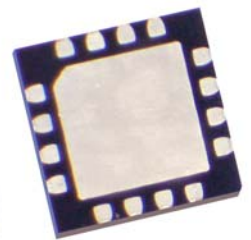

Absolute Maximum Ratings

Symbol	Parameters/conditions	Min.	Max.	Units
Vee1,2	Power supply voltage	-8	0	V
Vd	Applied voltage at data input (differential)		3	V
Vm	Applied voltage at data input (single ended)		1.5	V
Ioffset(+),(-)	Offset control current		5	mA
Tch	Maximum channel temperature		150	°C
Tstg	Storage temperature	-65	150	°C

Recommended Operating Conditions

Symbol	Parameters/conditions	Min.	Typ.	Max.	Units
Tc	Operating temperature range (Tcase)	0		85	°C
Vee1	Power supply voltage	-5.45	-5.2	-4.95	V
Vee2	Power supply voltage	-5.45	-5.2	-4.95	V
Iee1+Iee2	Total bias supply current	102	120	132	mA
Voffset (+)	Offset control voltage	-5		5	V
Voffset (-)	Offset control voltage	-5		5	V
Vctrl	Amplitude voltage control	-5.2		0	V
Vd	Applied peak to peak voltage at data input (differential)	6		1000	mV
Vm	Applied peak to peak voltage at data input (single ended)	12		1000	mV
	Input/output interface	AC and DC coupled			
Vindc	DC input voltage (with DC-coupled input)	-0.5		0.5	V
R	Bit rate			12.5	Gb/s



iT3018 12.5 Gb/s High-Gain RX Limiter Amplifier

Electrical Characteristics

At ambient temperature
Vee1,2=-5.2 V

Symbol	Parameters/conditions	Min.	Typ.	Max.	Units
P	Power consumption	530	624	686	mW
G	Differential small signal gain	49	50		dB
B3dB	3 dB bandwidth	9	10		GHz
RLin	Input return loss (up to 10 GHz)	10	20		dB
RLout	Output return loss (up to 10 GHz)	10	15		dB
Vin	Input sensitivity Diff. Input (BER<1E-12, 2 ²³ -1PRBS, 12.5 Gb/s)	+/-3			mVpp
Vout	Output peak to peak voltage (either Q or /Q)				
	Output DC coupled (Vctrl=0 V for max. voltage)	1010	1100		mVpp
	Output AC coupled (Vctrl=0 V for max. voltage)	740	800		mVpp
ΔVout	Vout sensitivity vs bias (Vee=-5.2 V +/-5%)			+/-11	%
Voutdc	DC output voltage (DC coupled to 50 ohm load)	-750	-650	-550	mV
Trse	Rise time (20% - 80%)		24	30	ps
Tfse	Fall time (20% - 80%)		22	26	ps
Jpp	Jitter peak to peak		12	17	ps

S-Parameter Data

Measured on connectorized evaluation board

Vee1=Vee2=-5.2 V
Iee1+Iee2=120 mA

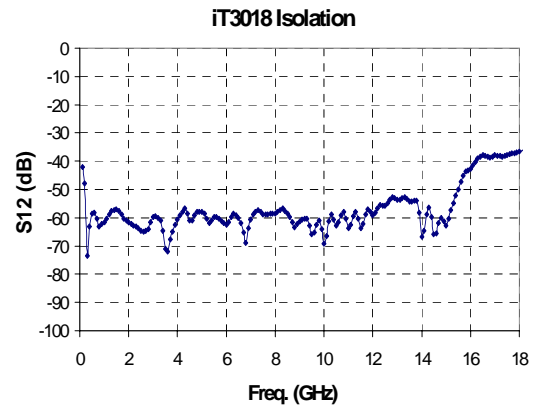
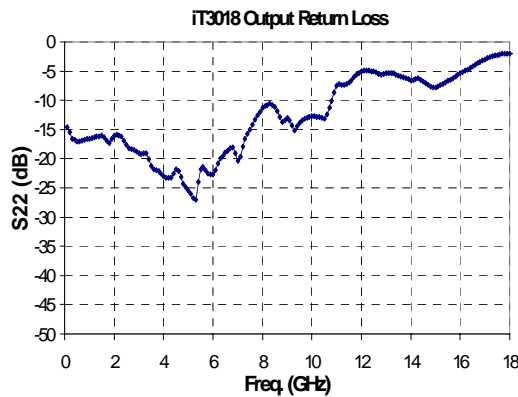
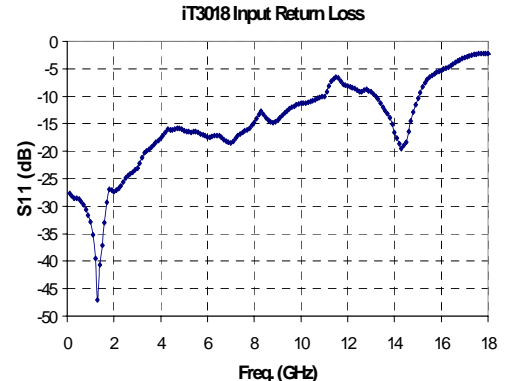
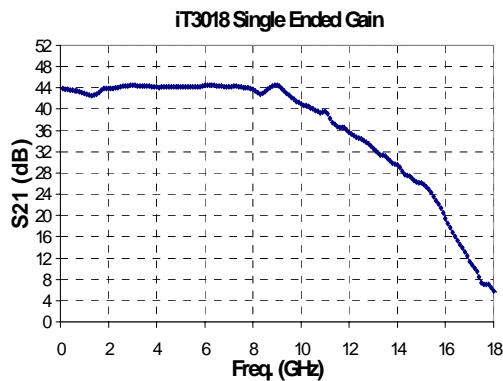

iT3018

12.5 Gb/s High-Gain RX Limiter Amplifier

Eye Diagram Performance

Vee1=Vee2=-5.2 V
Iee1+Iee2=120 mA

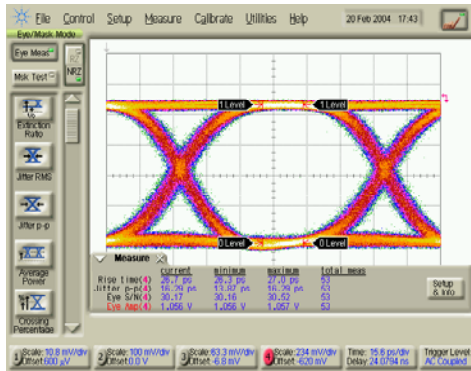

Bit rate: 10.7 Gb/s
Vin=+-5 mVpp, Vout=+-1 Vpp

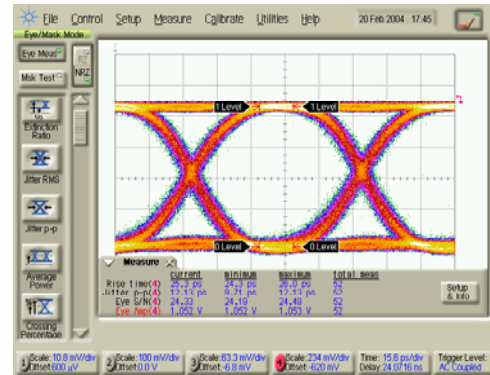

Bit rate: 12.5 Gb/s
Vin=+-5 mVpp, Vout=+-1Vpp

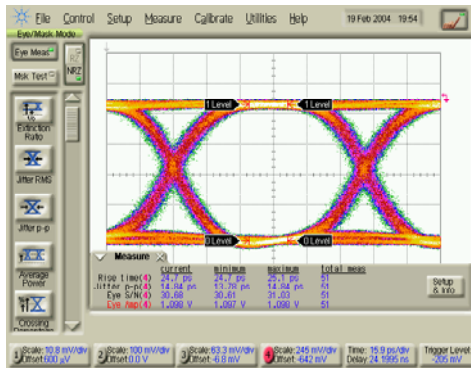

Bit rate: 10.7 Gb/s
Vin=+-8 mVpp, Vout=+-1.1 mVpp

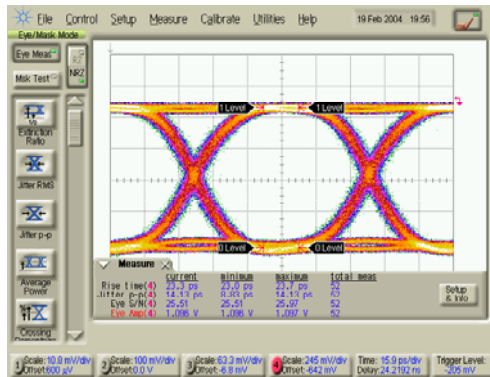

Bit rate: 12.5 Gb/s
Vin=+-8 mVpp, Vout=+-1.1 mVpp

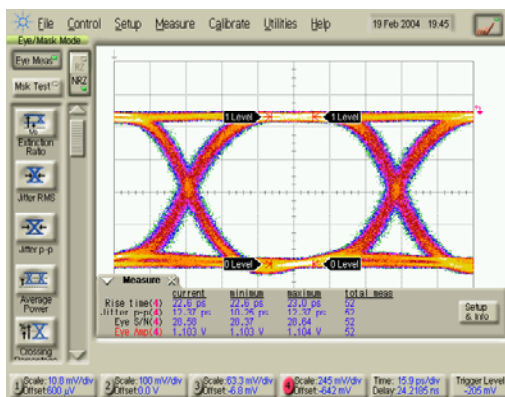

Bit rate: 10.7 Gb/s
Vin=+-30 mVpp, Vout=+-1.1 Vpp

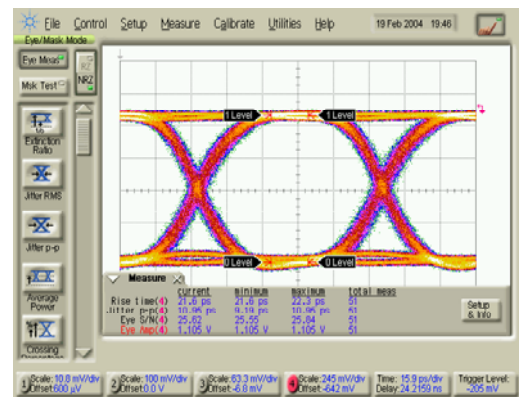

Bit rate: 12.5 Gb/s
Vin=+-30 mVpp, Vout=+-1.1 Vpp

Eye Diagram Performance vs. Input Voltage (cont.)

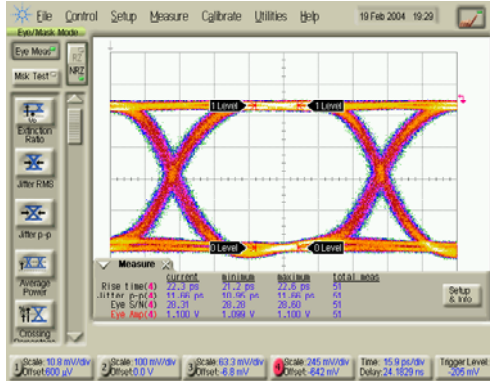

Bit rate: 10.7 Gb/s
Vin=+-200 mVpp, Vout=+-1.1 Vpp

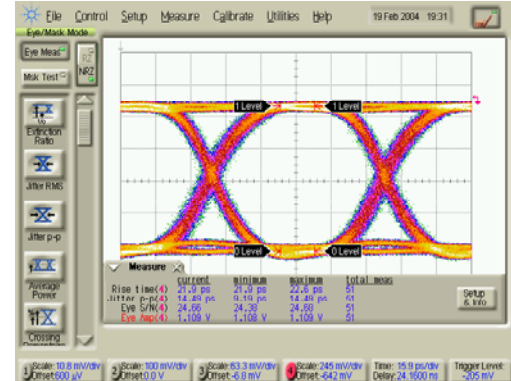

Bit rate: 12.5 Gb/s
Vin=+-200 mVpp, Vout=+-1.1 Vpp

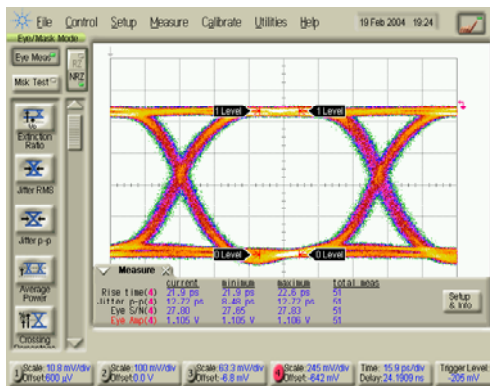

Bit rate: 10.7 Gb/s
Vin=+-1 Vpp, Vout=+-1.1 Vpp

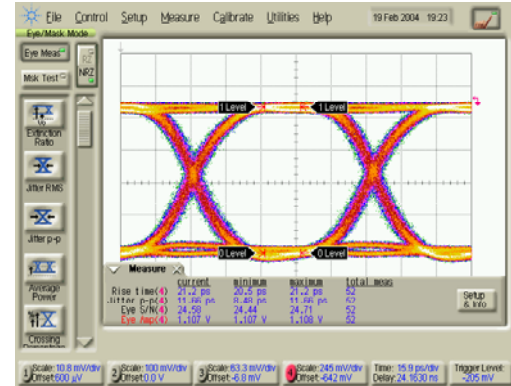

Bit rate: 12.5 Gb/s
Vin=+-1 Vpp, Vout=+-1.1 Vpp

Input Sensitivity

Vee1=Vee2=-5.2 V
Iee1+Iee2=120 mA

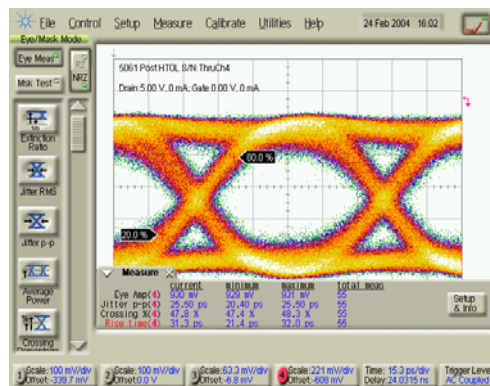

Input Sensitivity= 3mVpp Differential input up to 12.5 Gb/s
BER<1E-12. Output voltage = 930 mVpp single-ended

Performance As a Function Of Input Voltage

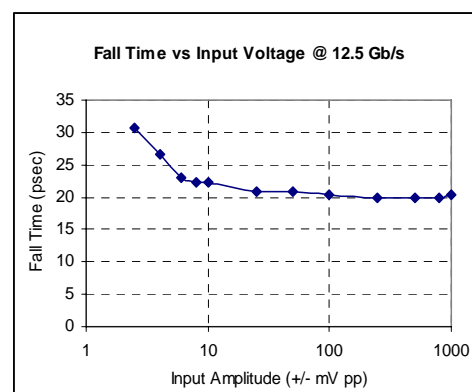
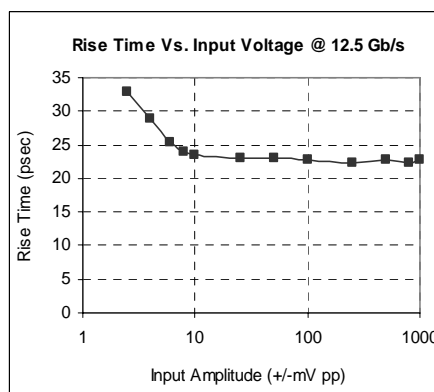
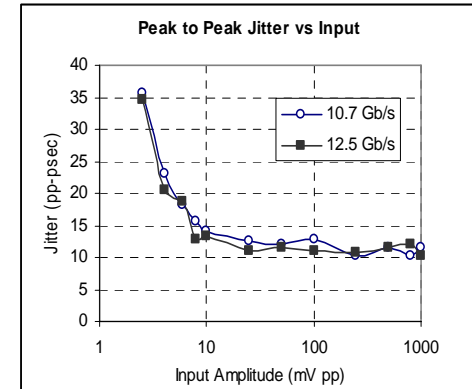
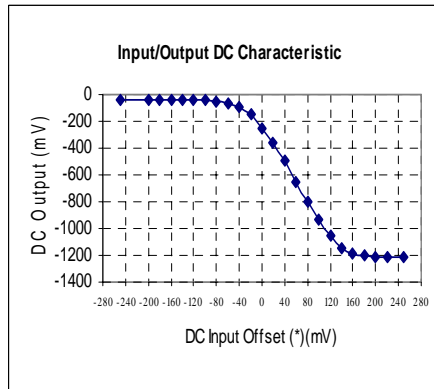
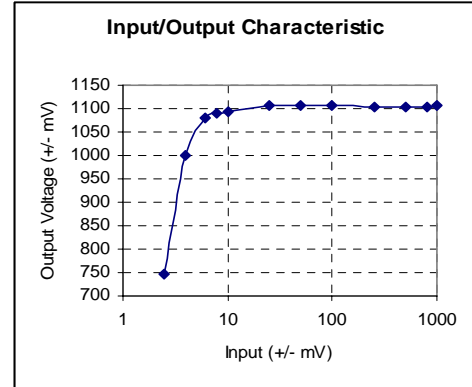
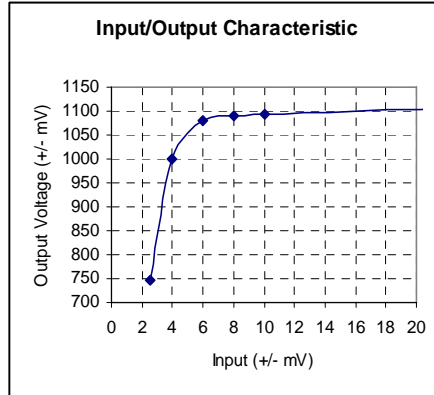

(*) Input applied to the offset control pin (Voffset1), open output.

Output Voltage Control

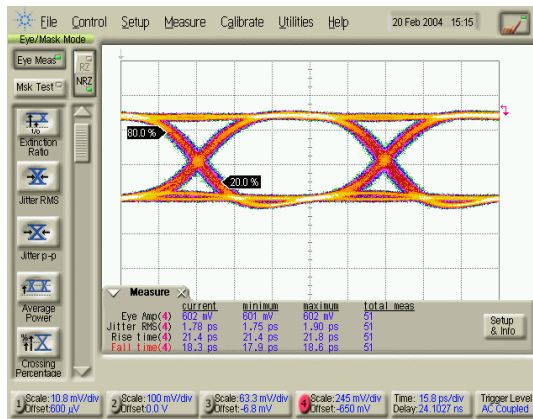
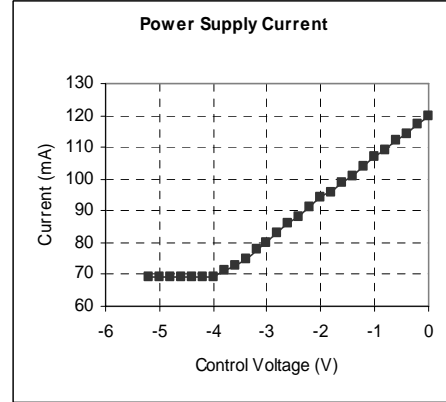
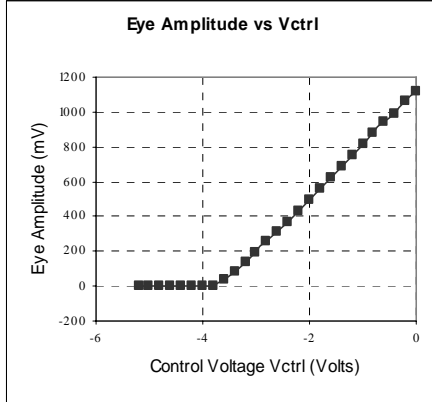

Bit rate: 12.5 Gb/s, Vctrl=-1.7 V
Vin=+/-200 mVpp, Vout=+/-602 mVpp

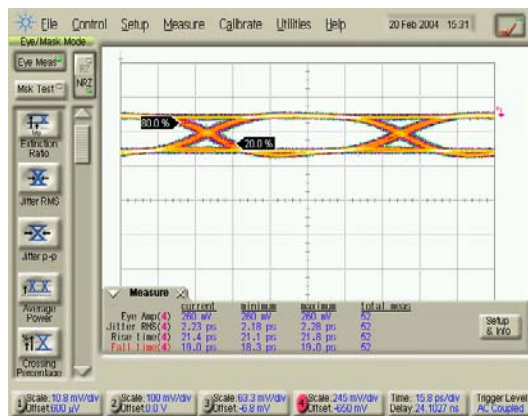

Bit rate: 12.5 Gb/s, Vctrl=-2.8 V
Vin=+/-200 mVpp, Vout=+/-260 mVpp

Recommended Operational Setup

Apply -5.2 V at Vee1 and Vee2
Apply 0 V at Vctrl
for maximum output

DC blocking capacitors optional

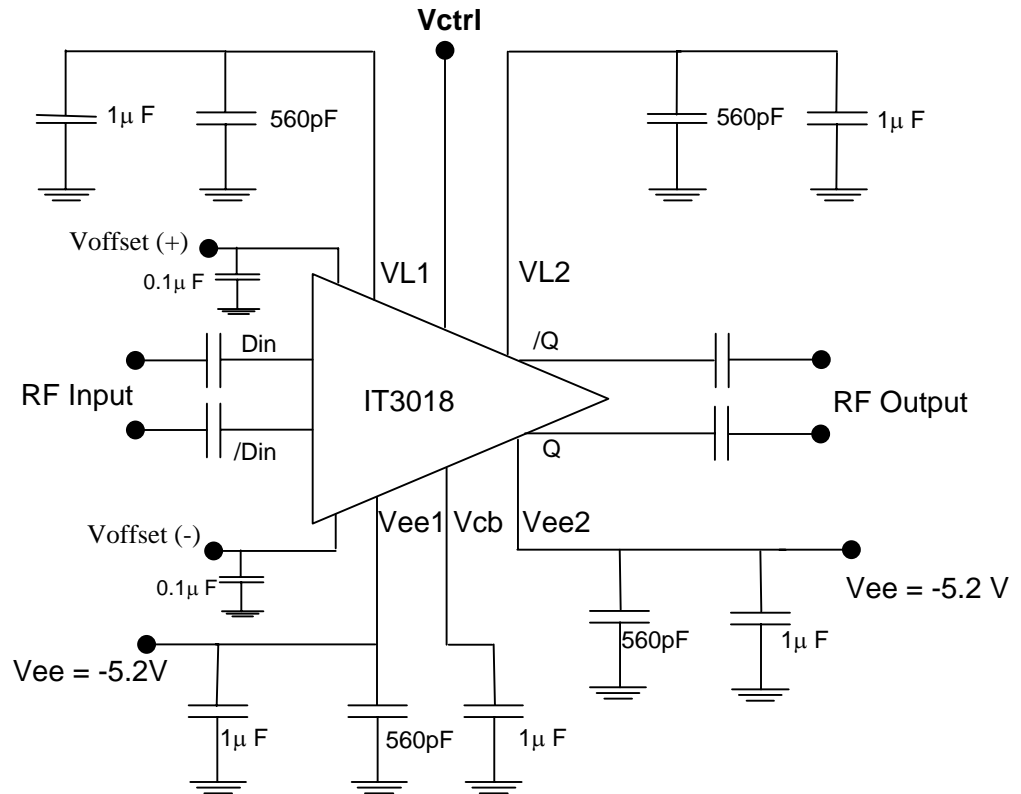

Package Drawings and Pinouts

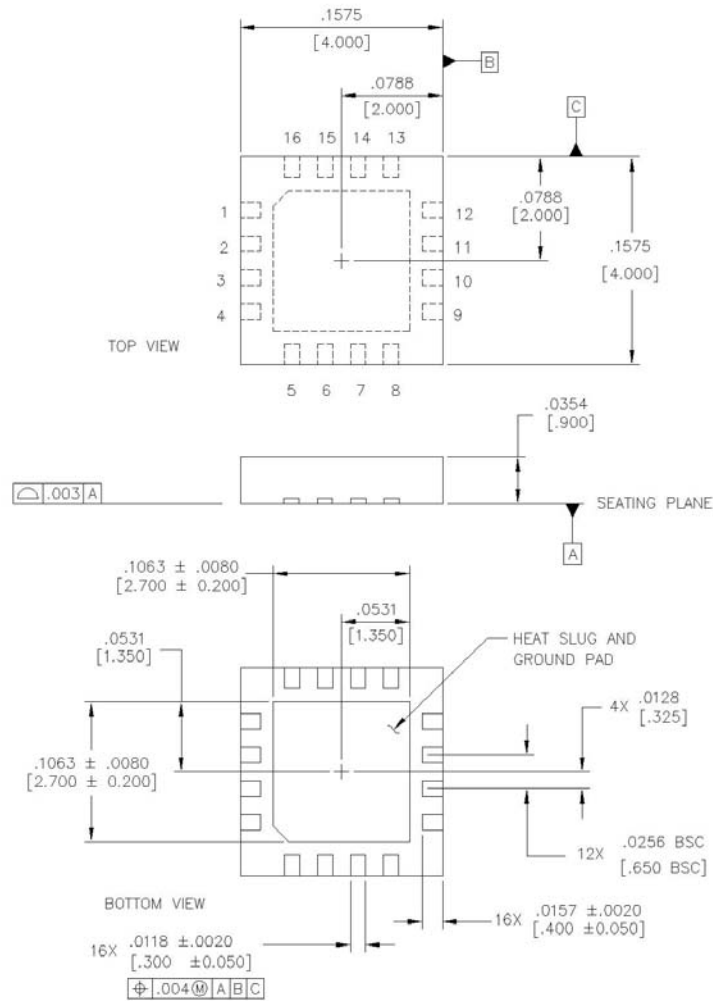

Pin Outs:

P1: GND	P9: GND
P2: Din (RF Input)	P10: Q (RF Out)
P3: /Din (RF Input)	P11: /Q (/RF Out)
P4: GND	P12: GND
P5: Voffset (-)	P13: VL1
P6: Vee1	P14: Vctrl (voltage control)
P7: Vcb	P15: VL2
P8: Vee2	P16: Voffset (+)

NOTES: (UNLESS OTHERWISE SPECIFIED)

1. DIMENSIONS: INCHES [mm]
2. EXCEPT WHERE NOTED, TOLERANCE ON DIMENSIONS ARE: $\pm \frac{.0039}{[0.100]}$