

TORISAN

ENGINEERING SPECIFICATIONS

TFT COLOR LCD MODULE

TM150XG-26L07

- 38cm (15.0 inch) diagonal
- XGA resolution (1024 × RGB × 768 dots)
- Dual Interface
- Analog RGB Interface
- Digital Interface
- Wide View Angle
- Ear mount
- With Inverter CFL backlight unit
- Nonglare surface type

(Preliminary)

Ver.1 July. 2, 2001

Tottori SANYO Electric Co., Ltd.
Electronic Device Business Headquarters
LCD Tottori Division

3-201, Minami-yoshikata, Tottori, 680-8634 Japan

TEL: 81-857-21-2941, 1958

FAX: 81-857-21-2265

General Manager

S. IWASAKI

Department Manager

T. FUJITA

Engineering Manager

N. OMOTE

MECHANICAL CHARACTERISTICS

Ta=25 °C

ITEM	SPECIFICATION	UNIT
LCD module size	331.6(W) × 254.75(H) × 29.5(T)	mm
Resolution	1024 × RGB(W) × 768(H)	pixel
Sub pixel pitch	0.099(W) × 0.297(H)	mm
Pixel pitch	0.297(W) × 0.297(H)	mm
Active viewing area	304.1(W) × 228.1(H)	mm
Bezel opening area	307.2(W) × 231.1(H)	mm
Weight	(1900)TYP.	g

OPTICAL CHARACTERISTICS

Ta=25°C, VDD=3.3V, fv=60Hz

ITEM	SYMBOL	CONDITIONS	MIN	TYP	MAX	UNIT	NOTE	
Brightness	B	$\phi = 0^\circ$	TBD	(250)	-	cd/m ²	Note 5,8	
Brightness uniformity		$\phi = 0^\circ$	-	-	TBD	-	Note 5,6,8	
Contrast ratio	CR	$\phi = 0^\circ$	-	(300)	-	-	Note 2,4,8	
Viewing angle range	ϕ	CR>10	$\theta = 0^\circ$	-	(55)	-	deg.	Note 1,2,4,8
			$\theta = 90^\circ$	-	(60)	-		
			$\theta = 180^\circ$	-	(50)	-		
			$\theta = 270^\circ$	-	(60)	-		
Response time	Rise	tr	-	(20)	-	ms.	Note 3,4,8	
	Fall	tf	-	(5)	-			
Color of CIE Coordinate	Red	x	-	TBD	-	-	Note 4,8	
		y	-	TBD	-			
	Green	x	-	TBD	-			
		y	-	TBD	-			
	Blue	x	-	TBD	-			
		y	-	TBD	-			
	White	x	-	TBD	-			
		y	-	TBD	-			

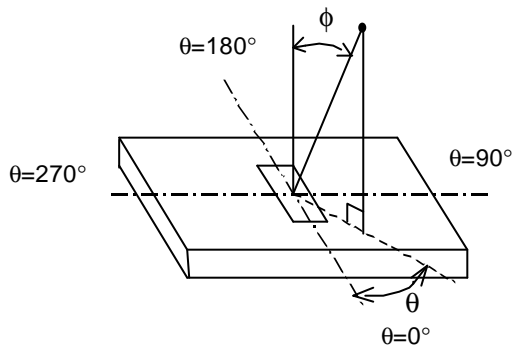

[Note 1] ϕ and θ

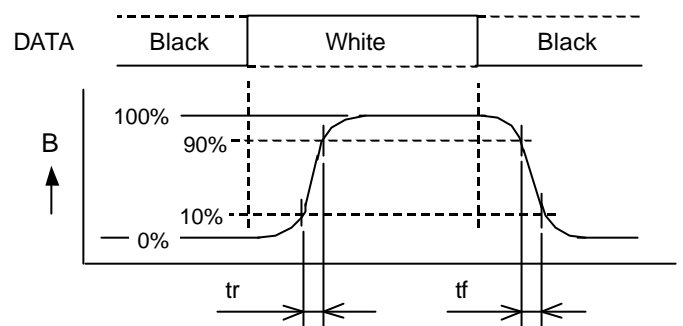

[Note 3] Response time

[Note 2] Contrast ratio "CR"

$$CR = \frac{\text{Brightness at White}}{\text{Brightness at Black}}$$

[Note 4] This shall be measured at center point No.3 of Note 7.

[Note 5] The brightness shall be the average of the following 5 points of Note 7.

[Note 6] The brightness uniformity shall be calculated by using following formula.

$$\text{Brightness uniformity} = \frac{\text{Maximum brightness of 5 points}}{\text{Minimum brightness of 5 points}}$$

[Note 7] Measurement points

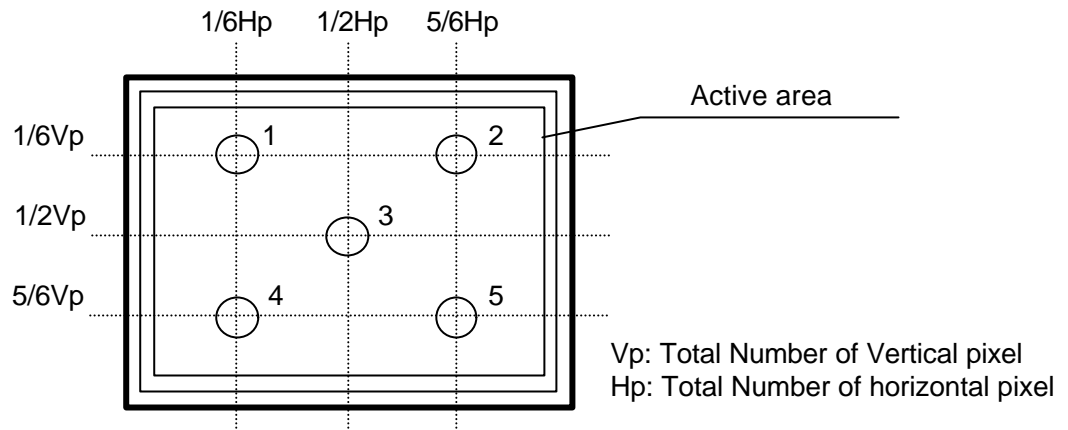

[Note 8] Measurement condition

- (1) Measurement equipment: BM-5A (TOPCON Corp.), Field=2°
- (2) Ambient temperature T_a : $25 \pm 2^\circ\text{C}$
- (3) LCD: All pixels are WHITE, $V_{DD}=3.3\text{V}$, $f_v=60\text{Hz}$
- (4) Measure after 30 minutes of CFL warm up.
- (5) $IL=\text{TBDmArms}$

BACKLIGHT CHARACTERISTICS

This module is used the backlight with 2 CFL.
Please follow the characteristics of 1 CFL as below.

$T_a=25^\circ\text{C}$

ITEM	SYM.	CONDITIOS	MIN	TYP	MAX	UNIT	NOTE
Operating life	tOL		(50000)	-	-	Hours	at $IL= \text{TBD}$
Lamp current	IL		(3)	-	(8)	mArms	(Recommended value)

BLOCK DIAGRAM

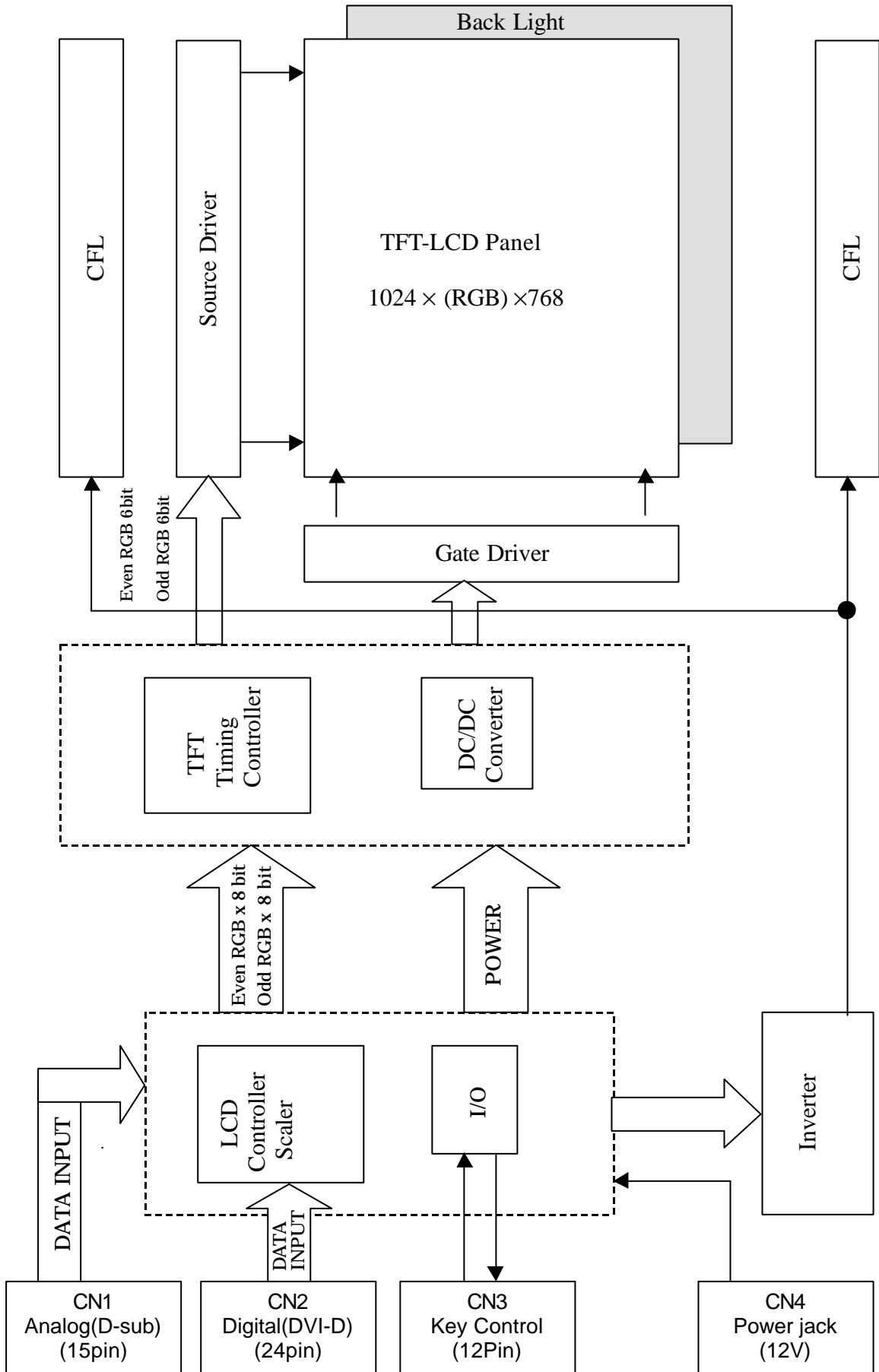

INTERFACE PIN CONNECTIONS

CN1 15PIN Analog RGB Interface CONECTOR : KSEY-15S-1A3F-19-13

PIN NO.	SYMBOL	FUNCTION
1	RED	DATA
2	GREEN	DATA
3	BLUE	DATA
4	ID2(GND)	GND
5	ST(GND)	GND
6	RED GND	GND
7	GREEN GND	GND
8	BLUE GND	GND
9	N C	NO CONNECTION
10	DIGITAL GND	GND
11	IDO(GND)	GND
12	SDA	BIDIRECTIONAL DATA
13	H-SYNC	HORIZONTAL SYNC
14	V-SYNC	VERTICAL SYNC
15	SCL	DATA CLK

Screen side is faced toward the bottom and top view.

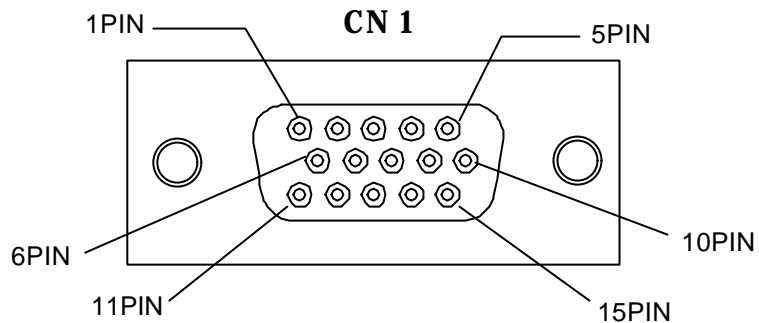

CN2 24PIN Digital Interface

Connector : SD-7432 (MOLEX)

PIN	SYMBOL	DESCRIPTION
1	RX2-	TMDS Negative differential input, channel 2
2	RX2+	TMDS Positive differential input, channel 2
3	GND	GND
4	NC	NC
5	NC	NC
6	SCL	CLOCK
7	SDA	Data
8	NC	NC
9	RC1-	TMDS Data 1-
10	RX1+	TMDS Data 1+
11	GND	GND
12	NC	NC
13	NC	NC
14	+5V	+5V Power
15	GND	Grond (Return for +5V,Hsync,and V Sync)
16	HP	Hot Plug
17	RX0-	TMDS Date 0-
18	RX0+	TMDS Date 0+
19	GND	GND
20	NC	NC
21	NC	NC
22	GND	GND
23	RX CLK +	TMDS Clock +
24	RX CLK-	TMDS Clock -

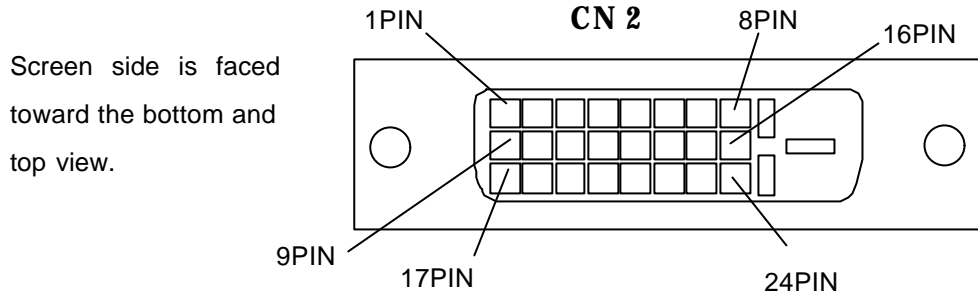

CN3 DC Power jack

DC power jack (CN3) : HEC4801 (HOSIDEN)

DC POWER JACK (CN3) PIN COFIGURATION

No	Symbol	Notes	Description
1	Vcc (12V)		
2	GND	1	

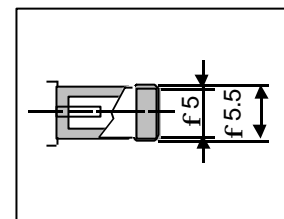
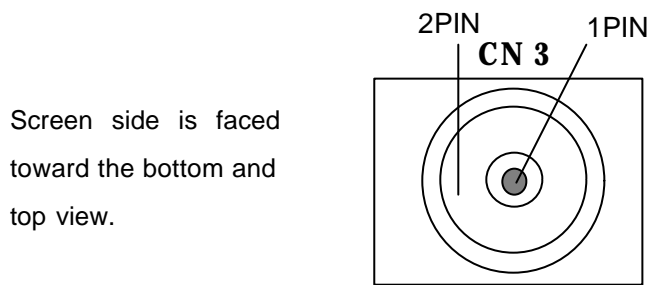

Recommend Plug 4

CN4 Key Control

Connector : 53261-1210 (MOLEX)

PIN NO.	SYMBOL	FUNCTION
1	VDD	+5V
2	LED-G	LED GREEN
3	LED-O	LED ORANGE
4	KEY-U	KEY UP
5	KEY-D	KEY DOWN
6	KEY-R	KEY RIGHT
7	KEY-L	KEY LEFT
8	LCD ON/OFF	LCD ON/OFF
9	RST	REST
10	BKA	BKLT ADJ
11	GND	GND
12	GND	GND

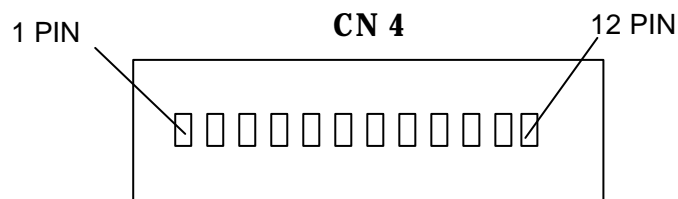

Screen side is faced toward the bottom and top view.

RECAUTIONS (INSTRUCTIONS FOR SAFE AND PROPER USE)

1. Instructions for safety

- (1) Please do not disassemble or modify LCD module to avoid the possibility of electric shock, damage of electronic components, scratch at display surface and invasion of foreign particles. In addition, such activity may result in fire accident due to burning of electronic component.
LCD module disassembled or modified by customer is out of warranty.
- (2) Please be careful in handling of LCD module with broken glass.
When the display glass breaks, please pay attention not to injure your fingers. The display surface has the plastic film attached, which prevents dispersion of glass pieces, however touching broken edge will injure your fingers. Also CFL (Cold Cathode Fluorescent Lamp) is made of glass, therefore please pay attention in the same way.
- (3) Please do not touch the fluid flown out of broken display glass.
If the fluid should stick to hand or clothes, wipe off with soap or alcohol immediately and then wash it with water. If the fluid should get in eyes, wash eyes immediately with washing lotion for more than 15 minutes and then consult the doctor.
- (4) Please make secure connection of CFL connector.
Please make sure that CFL connector from LCD module is connected with output connector on inverter circuit securely. Poor connection may cause smoke or fire accident due to high voltage in circuit. If connection may not be secure, please switch off the power supply for LCD module and CFL and then make secure connection.
Please do not make connection with another connector than recommended mating connector.
- (5) CFL contains mercury inside. Please follow regulations or rules established by local autonomy at its disposal.
- (6) Please be careful to electric shock.
Before handling LCD module, please switch off the power supply.
Since high voltage is applied to CFL terminal, cable, connector and inverter circuit in operation mode, touching them will cause electric shock.

2. Instructions for designing

- (1) Mounting of LCD
Please fix LCD module at all mounting flanges shown in this specification for installation onto system. The used screws should have proper dimensions.
Furthermore, designing of mounting parts should be adequate so that LCD module is not warped or twisted, to achieve good display quality.
- (2) Heat radiation
CFL generates heat at lighting and causes temperature rise inside system. Therefore, designing to radiate heat like radiation slits at cabinet is recommended to meet the specified operating temperature range for LCD module.
- (3) Noise on power line
Spike noise contained in power line causes abnormal operation of driving circuit and abnormal display. To avoid it, spike noise should be suppressed below $VDD \pm 200\text{mVp-p}$. (In any case, absolute maximum rating should be kept.)

- (4) **Power sequence**
Before LCD module is switched on, please make sure that power supply and input signals of system, testing equipment, etc. meet the recommended power sequence.
- (5) **Absolute maximum rating**
Absolute maximum rating specified in this specification has to be kept in any case. It shows the maximum that cannot be exceeded.
Exceeding it may cause burning or non-recoverable break of electronic components in circuit. Please make system design so that absolute maximum rating is not exceeded even if ambient temperature, input signal and components are varied.
- (6) **Protection for power supply**
Please study to adapt protection for power supply against trouble of LCD module, depending on usage condition of system. Fuse installed on LCD module should be never modified. Any modification to make the function of fuse ineffective may cause burning or break of printed wiring board or other components at circuit trouble.
- (7) **Protection against electric shock**
High voltage is applied to CFL connector, inverter circuit and CFL at lighting. Please make design not to expose or be accessible to such high voltage parts to avoid electric shock.
- (8) **Protection cover and cut-off filter for ultraviolet rays**
When LCD module is used under severe condition like outdoor, it is recommended to use transparent protection cover over display surface to avoid scratches and invasion of dust and water. In addition, when LCD module is exposed to direct sun light for long time, use of cut-off filter for ultraviolet rays is also recommended. Please be careful not to get condensation.

3. Instructions for use and handling

- (1) **Protection against Static electricity**
C-MOS LSI and semiconductors are easily damaged by static discharge. LCD module should be handled on conductive mat by person grounded with wrist strap etc. to avoid getting static electricity. Please be careful not to generate static electricity during operation.
- (2) **Protection against dust and stain**
LCD module should be handled in circumstance as clean as possible.
It is recommended to wear fingerstalls or ductless and soft gloves before handling to avoid getting dust or stain on display surface.
- (3) **Protection film for display surface**
It is recommended to remove protection film at nearly final process of assembling to avoid getting scratch or dust. To remove film, please pick up its edge with dull-head tweezers or cellophane tape at first and then remove film gradually taking more than 3 seconds. If film is removed quickly, static electricity may be generated and may damage semiconductors or electronic components.
- (4) **Contamination of display surface**
When display surface of LCD module is contaminated, please wipe the surface softly with cotton swab or clean cloth. If it is not enough, please take it away with cellophane tape or wipe the surface with cotton swab or clean cloth containing benzene. In this case, please be careful so that benzene does not get in inside of LCD module, because it may be damaged.

- (5) Water drop on LCD surface
Please do not leave LCD module with water drop. When the display surface gets water drop, please wipe it off with cotton swab or soft cloth immediately, otherwise display surface will be deteriorated.
If water gets in inside of LCD module, circuit may be damaged.
- (6) Please make sure that LCD module is not warped or twisted at installation into system. Even temporary warp or twist may be the cause for failure.
- (7) Mechanical stress
Please be careful not to apply strong mechanical stress like drop or shock to LCD module. Such stress may cause break of display glass and CFL or may be the cause for failure.
- (8) Pressure to display surface
Please be careful not to apply strong pressure to display surface. Such pressure may cause scratches at surface or may be the cause of failure.
- (9) Protection against scratch
Please be careful not to hit, press or rub the display surface with hard material like tools. In addition, please do not put heavy or hard material on display surface, and do not stack LCD modules. Polarizer at front surface can be easily scratched.
- (10) Plugging in of connector
Please be careful not to apply strong stress to connector part of LCD module at plugging in or out, because strong stress may damage the inside connection. At plugging in connector, place LCD module on the flat surface and hold the backside of connector on LCD module. Please make sure that connector is plugged in correctly. Insecure connection may be the cause for failure during operation.
In addition, please be careful not to put the connecting cable between cabinet of system and LCD module at installing LCD module into system.
- (11) Handling of CFL cable and FPC (Flexible Printed Circuit)
Please be careful not to pull or scratch CFL cable, because CFL or soldered part of cable may be damaged consequently.
Also FPC should not be pulled or scratched.
- (12) Switching off before plugging in connector
Please make sure that power is switched off before plugging in connector.
If power is on at plugging in or out, circuit of LCD module may be damaged.
When LCD is switched on for test or inspection, please make sure that power supply and input signals of driving system meet the specified power sequence.
- (13) Temperature dependence of LCD display
Response speed (optical response) of LCD display is dependent on temperature.
Under low temperature, response speed is slower.
Also brightness and chromaticity change slightly depending on temperature.
- (14) Slow light-up of CFL under low temperature
Under low temperature, start-up of CFL gets difficult. (The time from switch-on to stable lighting becomes longer.)
As characteristic of CFL, operation under low temperature makes the life time shorter. To avoid this, it is recommended to operate under normal temperature
- (15) Condensation
LCD module may get condensation on its display surface and inside in the circumstance where temperature changes much in short time.
Condensation can cause deterioration or failure. Therefore, please be careful not to get condensation.

- (16) Remaining of image
Displaying the same pattern for long time may cause remaining of image even after changing the pattern. This is not failure but will disappear with time.

4. Instructions for storage and transportation

- (1) Storage
Please store LCD module in the dark place of room temperature and low humidity in original packing condition, to avoid condensation that may cause failure. Since sudden temperature change may cause condensation, please store in circumstance of stable temperature.
- (2) Stacking number
Since excessive weight causes deformation and damage of carton box, please stack only up to the number stated on carton box for storage and transportation.
- (3) Handling
Since LCD module consists of glass and precise electronic components, it will be damaged by excessive shock and drop. Therefore, please handle the carton box carefully to minimize shock at loading, reloading and transportation.

■ Outer Dimensions (FRONT SIDE)

Rev. A May. 29. 2001

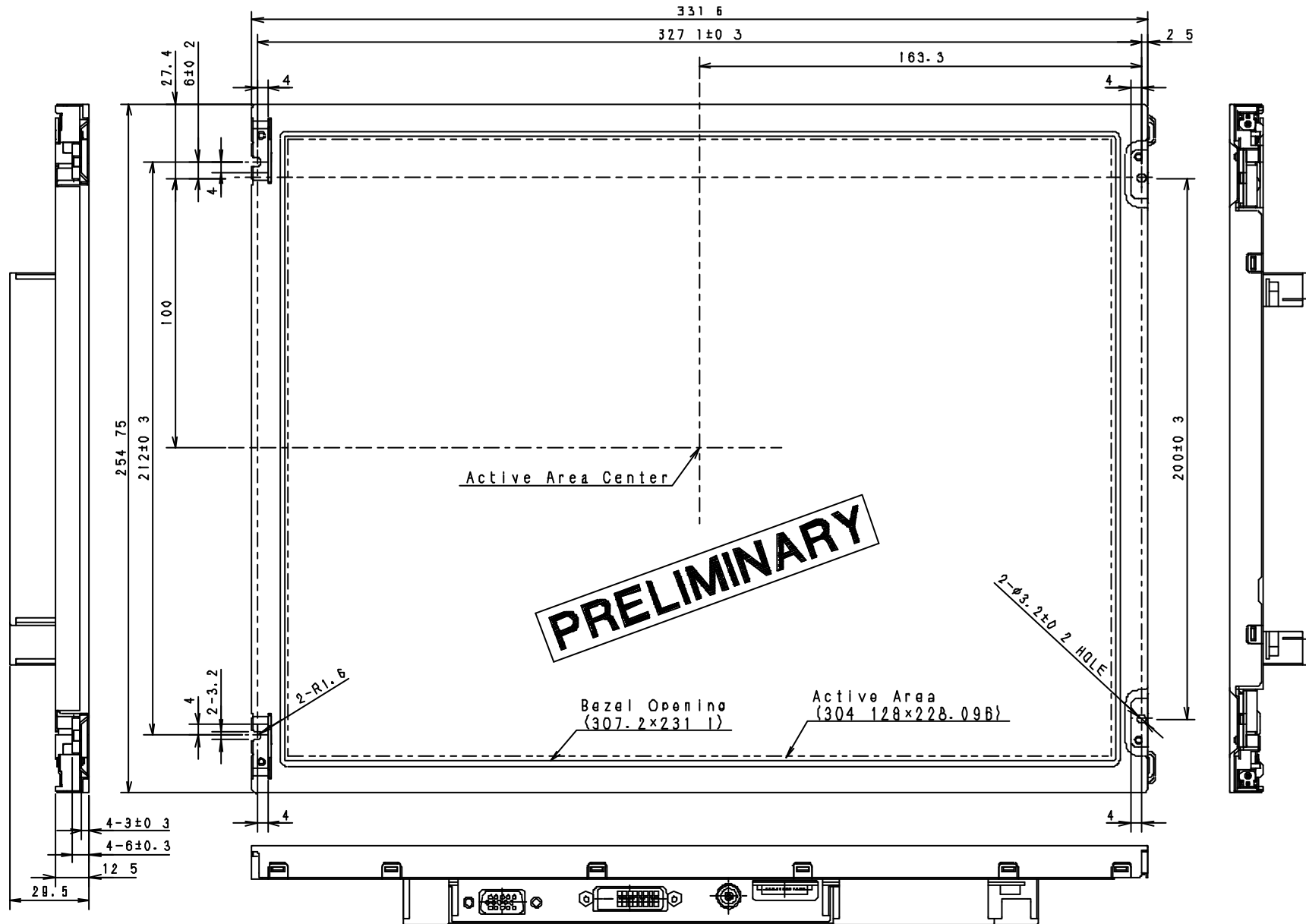

PRELIMINARY

Note1: Unspecified dimension tolerances to be ±0.5mm
Note2: This drawing is only preliminary data and can be changed without previous notices.

Unit:mm

Outer Dimensions (BACK SIDE)

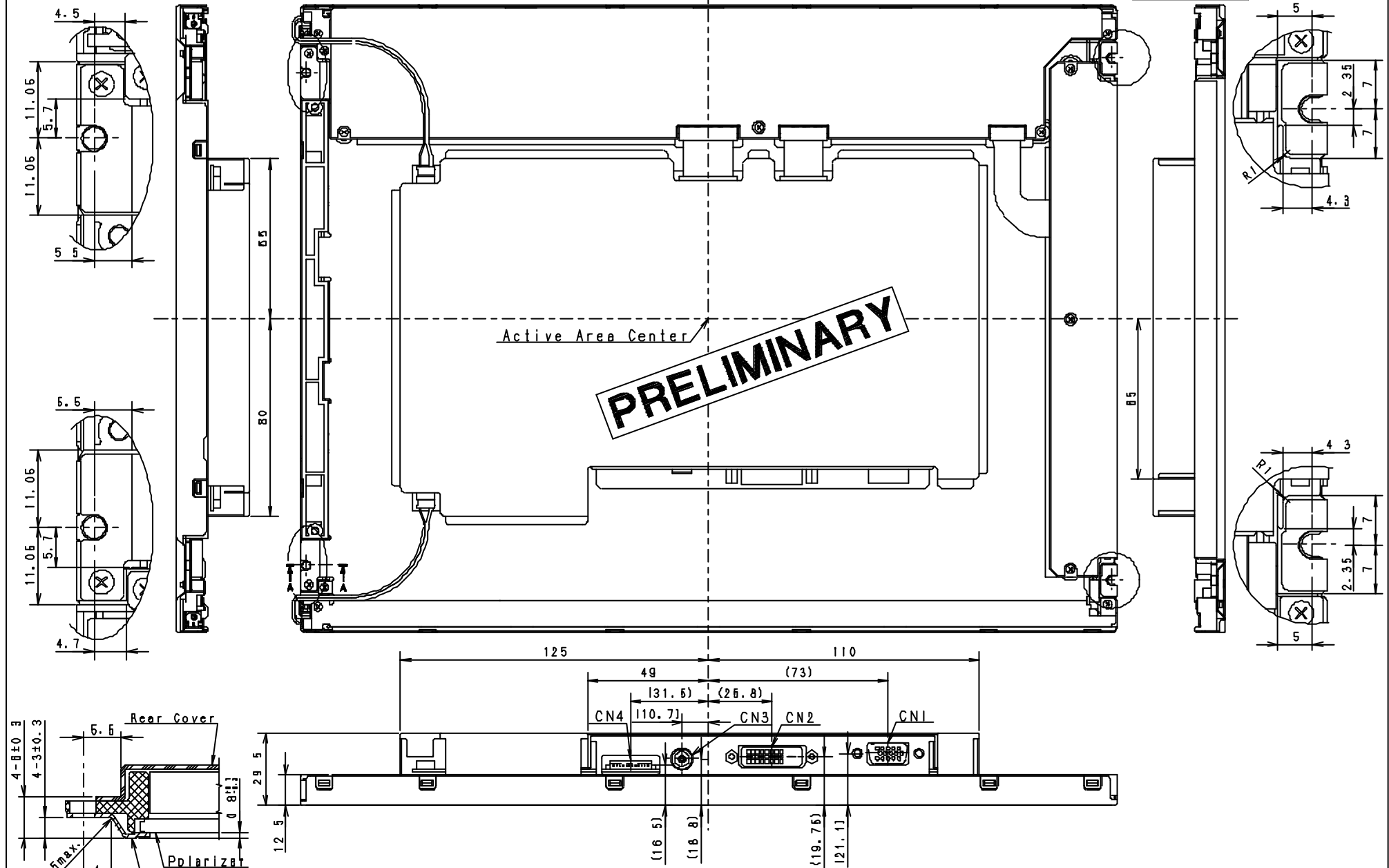

PRELIMINARY

Active Area Center

A-A sec

- CN1: Analogue ID-sub / K8EY-15B-1A3F19-13 (JST)
- CN2: Digital (DVI-D) / DV2R024N11 (JAEI or MOLEX)
- CN3: DC (12V) / HEC4B01 (HDSIDEN)
- CN4: KEY/53261-1290 (MOLEX)

Note1: Unspecified dimension tolerances to be ±0.5mm
 Note2: This drawing is only preliminary data and can be changed without previous notices.

Unit: mm