

# HITACHI

Hitachi Displays, Ltd.

Date; Sep. 8, 2003

For Messrs. Hitachi Europe Ltd.  
CUSTOMER'S ACCEPTANCE SPECIFICATIONS

## TX18D16VM1CAA

### CONTENTS

No.	Item	Sheet No.	Page
-	COVER	3284PS 2601-TX18D16VM1CAA-1	1-1/1
-	RECORD OF REVISION	3284PS 2602-TX18D16VM1CAA-1	2-1/1
-	DESCRIPTION	3284PS 2603-TX18D16VM1CAA-1	3-1/1
1	ABSOLUTE MAXIMUM RATINGS	3284PS 2604-TX18D16VM1CAA-1	4-1/1
2	OPTICAL CHARACTERISTICS	3284PS 2605-TX18D16VM1CAA-1	5-1/2 - 5-2/2
3	ELECTRICAL CHARACTERISTICS	3284PS 2606-TX18D16VM1CAA-1	6-1/1
4	BLOCK DIAGRAM	3284PS 2607-TX18D16VM1CAA-1	7-1/1
5	INTERFACE PIN CONNECTION	3284PS 2608-TX18D16VM1CAA-1	8-1/2 - 8-2/2
6	INTERFACE TIMING	3284PS 2609-TX18D16VM1CAA-1	9-1/3 - 9-3/3
7	DIMENSIONAL OUTLINE	3284PS 2610-TX18D16VM1CAA-1	10-1/1
8	DESIGNATION OF LOT MARK	3284PS 2611-TX18D16VM1CAA-1	11-1/1
9	COSMETIC SPECIFICATIONS	3284PS 2612-TX18D16VM1CAA-1	12-1/3 - 12-3/3
10	PRECAUTIONS	3284PS 2613-TX18D16VM1CAA-1	13-1/3 - 13-3/3

Please return 1 copy with your signature on this page for approval.

Accepted by : \_\_\_\_\_

Proposed by : \_\_\_\_\_

Date : \_\_\_\_\_

CAS-S03-154

Hitachi Displays, Ltd.	Sh. No.	3284PS 2601-TX18D16VM1CAA-1	Page 1-1/1
------------------------	------------	-----------------------------	------------

**RECORD OF REVISION**

Date	The upper section:Before revision The lower section:After revision		Summary
	Sheet No.	Page	

### DESCRIPTION

The specifications are applied to the following TFT Liquid Crystal Display Module with Back-light unit.

Note : Inverter device for Back-Light is not built in, so it should be prepared by yourself .

Product name	TX18D16VM1CAA	
Effective Display Area	(H)152.4 x (V)91.44	[mm]
Display Dots	(H)(800x3) x (V)480	[dots]
(Display Pixels)	(H 800 x V 480)	[pixels]
Pixel Pitch	(H)0.1905 x (V)0.1905	[mm]
Color Pixel Arrangement	R+G+B Vertical Stripe	
Display Mode	Transmissive Mode, Normally White Mode	
Surface Polarizing Film	Polarizing Film with Antiglare Coating	
Number of Colors	262k	[colors]
Interface	C-MOS, R.G.B x 6 bit Digital each	
Color Saturation	60%(typ) for NTSC	
Viewing Angle	12 o'clock. (The direction it's hard to be discolored)	
Backlight	CCFL, 1pc Side-light type (U shape)	
Dimensions Outline	(H)165.0(typ) x (V)106.0(typ) x (t)10.5(max)	[mm]
Weight	Approximately 170	[g]

# 1. ABSOLUTE MAXIMUM RATINGS

## 1.1 ENVIRONMENTAL ABSOLUTE MAXIMUM RATINGS

Item	Operating		Non-operation		Unit	Note
	Min.	Max.	Min.	Max.		
Temperature	0	70	-20	70		1)
Humidity	2)		2)		%RH	1)
Vibration		4.9 (0.5G)		19.6 (2G)	m/s <sup>2</sup>	3)
Shock				490 (50G)	m/s <sup>2</sup>	4)
Corrosive Gas	Not Acceptable		Not Acceptable			
Illumination at LCD Surface		50,000		50,000	lx	

Notes 1) "Temperature" and "Humidity" shall be at glass surface of a TFT-LCD Module, not in the system installed with the Module.

It's should not be over these absolute maximum ratings at any position of a TFT-LCD Module. Operating temperature means the temperature a TFT-LCD Module can be driven, not mean guarantee the screen performance (contrast,brightness,response time etc) is judged at Ta=25deg.C

At low temperature the brightness of CCFL drop and the life time of CCFL become to be short.

2) Ambient temp. Ta 40 : 85 % RH Max. Without condensation.

Ta > 40 : Absolute humidity must be lower than the humidity of 85 % at 40 deg.C. Without condensation.

3) Frequency of the vibration shall be between 20 Hz and 50 Hz. (except resonance point)

4) Pulse width of the shock shall be 7 ms.

## 1.2 ELECTRICAL ABSOLUTE MAXIMUM RATINGS

### (1) TFT LIQUID CRYSTAL DISPLAY MODULE

VSS=0V

Item	Symbol	Min.	Max.	Unit	Note
Power Supply Voltage for logic	VDD	0	4.0	V	
Input signal Voltage for logic	VI	-0.2	VDD+0.2	V	1)
Electrostatic Durability	VESD0	±100		V	2), 3)
	VESD1	±8		kV	2), 4)

Notes 1) The specification is applied to pixel data signal,timing signal and clock signal.

2) Discharge circuit to be connected : 200 pF - 250 , Environmental : 25 - 70 % RH

3) The specification is applied to I/F connector pins.

4) The specification is applied to the surface of both a metal bezel and a LCD panel.

### (2) BACK-LIGHT UNIT

GND=0V

Item	Symbol	Min.	Max.	Unit	Note
Lamp Current	IL	-	7.0	mArms	1)
Lamp Voltage	VL	-	2000	Vrms	2)

Notes 1) To be measured at GND terminal side

2) The specification is applied at connector pins for back-light units .

## 2. OPTICAL CHARACTERISTICS

The following items are measured on the conditions that this unit operation (TFT panel and the Back-light) and measuring systems are stable. It takes about 15 minutes.

The ambient light excluding The Back-light unit is nothing.

•Measuring equipment : TOPCON BM-7, Prichard 1980A, or equivalent

•Measuring point : Active area center

$T_a = 25$  ,  $V_{DD} = 3.3 \text{ V}$ ,  $f_V = 60 \text{ Hz}$ ,  $I_L = 4.0 \text{ mA}$

Item	Symbol	Conditions	Min.	Typ.	Max.	Unit	Note	
Contrast Ratio	CR	=0 1)	100	200			2)	
Response Time	RISE		ton		20	40	ms	3)
	FALL		toff		10	20	ms	3)
Brightness (White)	Bwh			300	350		cd/m <sup>2</sup>	
Brightness Uniformity	Buni			70			%	4)
Color Position on CIE	Red		x	0.57	0.62	0.67		
			y	0.29	0.34	0.39		
	Green		x	0.24	0.29	0.34		
			y	0.55	0.60	0.65		
	Blue		x	0.09	0.14	0.19		
		y	0.02	0.07	0.12			
	White	x	0.25	0.30	0.35			
		y	0.26	0.31	0.36			
Viewing Angle (CR 10)	x - x'	x	=0 °	50		deg.	1)	
		x'	=180 °	50				
	y - y'	y	=90 °	50				
		y'	=270 °	50				

Notes 1) Definition of Viewing Angle

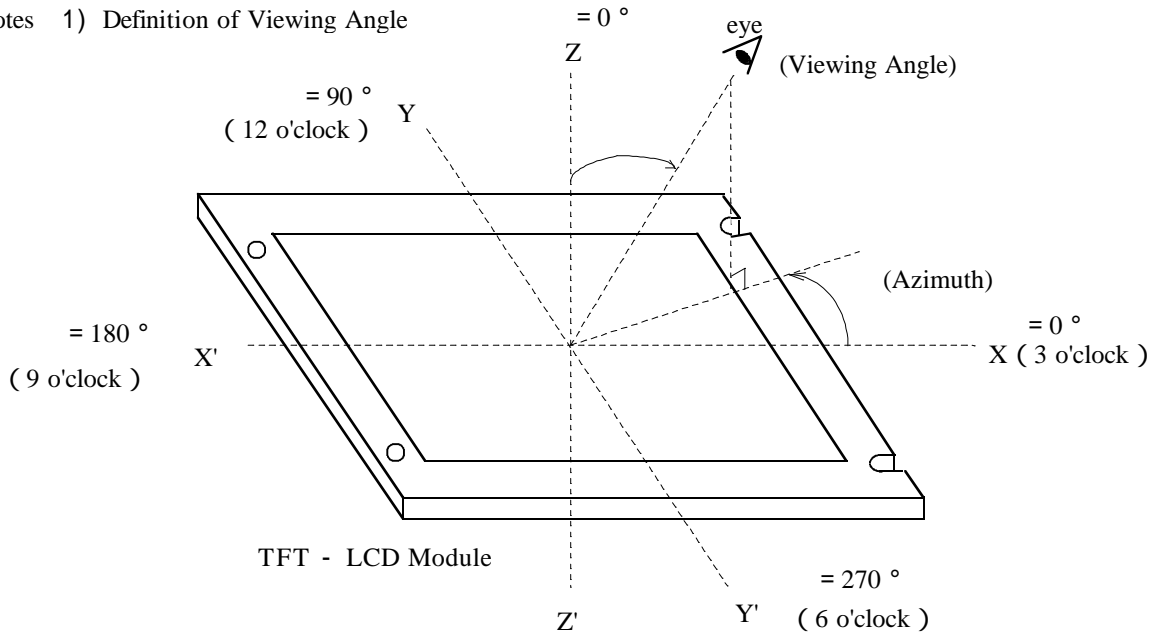

2) Definition of Contrast Ratio(CR):

$$CR = \frac{\text{(Luminance at displaying WHITE)}}{\text{(Luminance at displaying BLACK)}}$$

3) Definition of Response Time

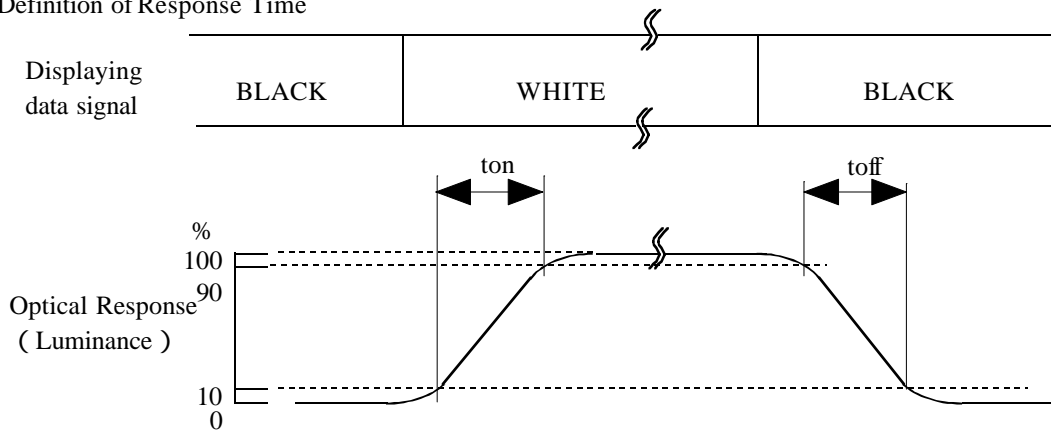

4) Definition of Brightness Uniformity

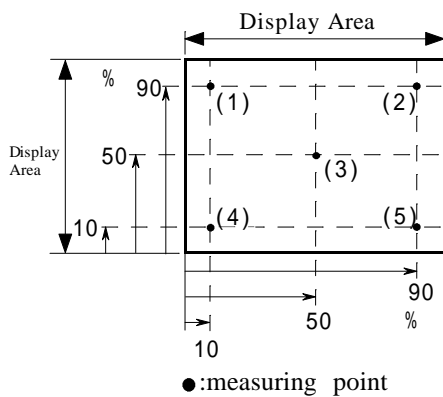

The brightness uniformity (Buni) is defined as the following equation.

$$Buni = \frac{Bmin}{Bmax} \times 100$$

where, Bmax = Maximum brightness among 5 measuring points  
Bmin = Minimum brightness among 5 measuring points

### 3. ELECTRICAL CHARACTERISTICS

#### 3.1 TFT LIQUIDO CRYSTAL DISPLAY MODULE

Ta = 25 , VSS = 0V

Item	Symbol	Min.	Typ.	Max.	Unit	Note
Power Supply Voltage	VDD	3.0	3.3	3.6	V	
Input Voltage for Logic Circuits	Hi	VIH	2.0	VDD	V	1)
	Lo	VIL	VSS	0.8	V	1)
Power Supply Current	IDD		250	350	mA	2), 3)
VSYNC Frequency	fV		60	75	Hz	
HSYNC Frequency	fH		31.6	39.2	kHz	
DCLK Frequency	fCLK		33.3	40	MHz	

- Notes 1) The specification is applied to pixel data signal, timing signal and clock signal.  
 2) fV = 60Hz , fCLK = 33.3 MHz, VDD = 3.3V, DC Current.

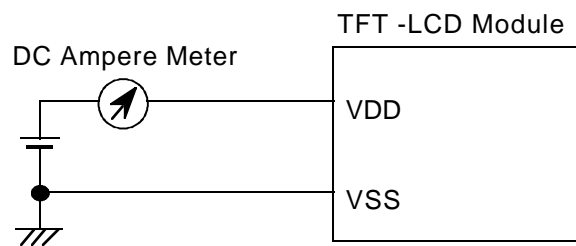

- Typical value is measured when displaying Black raster.  
 Maximum is measured when displaying Vertical-stripe pattern of 2 pixel pitch.  
 3) Current capacity for VDD power source should be larger than 2A.  
 This TFT-LCD Module has a fuse(1A).

#### 3.2 BACK-LIGHT UNIT

Ta = 25

Item	Symbol	Min.	Typ.	Max.	Unit	Note
Lamp Current	IL	2.0	3.0	4.0	mArms	1),3)
Lamp Voltage	VL		1000		Vrms	
Frequency	fL	50		70	kHz	2)
Starting Lamp Voltage	VS	1400		2000	Vrms	Ta=25deg. C
		1600		2000		Ta=0deg. C

#### Notes

- 1) Larger IL causes the shorter life of a CCFL.
- 2) Frequency of power supply for a CCFL may cause interference with HSYNC frequency and causes beat or flicker on the display. Therefore, lamp frequency shall be as different as possible from HSYNC frequency in order to avoid the interference.
- 3) To be measured at GND terminal side
- 4) Starting Lamp Voltage should be kept 1 sec at least.
- 5) The inverter should be built-in a safety circuit which detects over current, over voltage and distorted wave form of lamp current.

## 4. BLOCK DIAGRAM

### 4.1 TFT-LCD MODULE

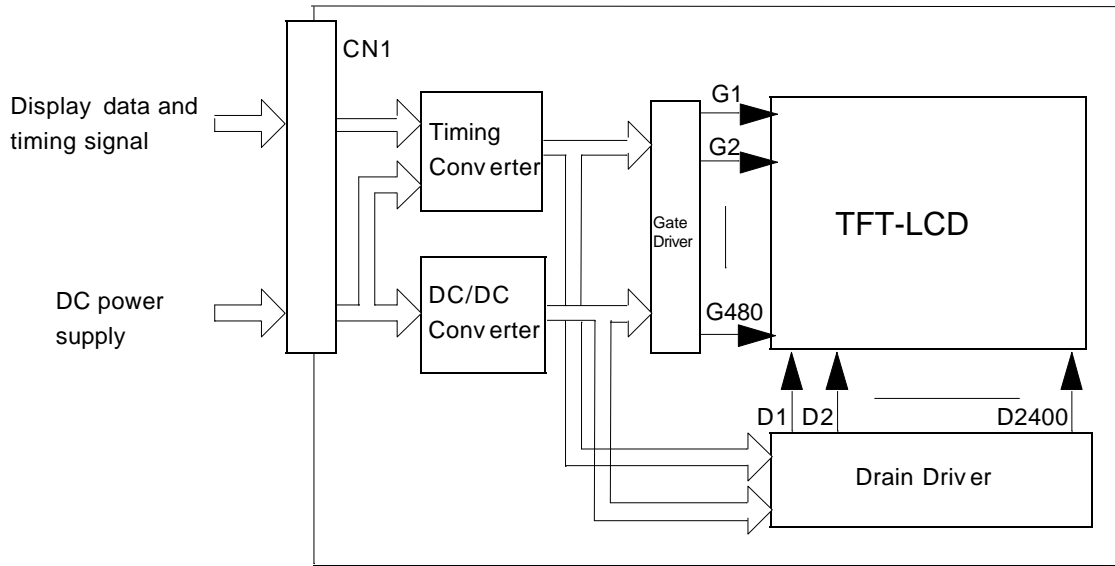

### 4.2 BACK-LIGHT UNIT

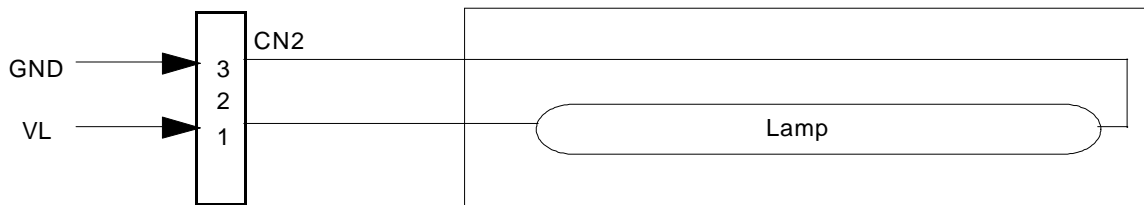

Color of wires from CCFL to CN2

- 3 ( GND ) : White
- 1 ( VL ) : Pink



## 5. INTERFACE PIN CONNECTION

### 5.1 TFT-LCD MODULE

CN1 《AE ;FA5B040HF1R3000》

Pin No.	Symbol	Description	Note
1	VDD	Power Supply (typ.+3.3V)	1)
2	VDD		
3	VDD		
4	VDD		
5	NC	Non-Connect	4)
6	DTMG	Display Timing	
7	VSS	GND (0V)	2)
8	NC	Non-Connect	4)
9	VSS	GND (0V)	2)
10	(IC)		3)
11	VSS	GND (0V)	2)
12	B5	Blue Data	
13	B4		
14	B3		
15	VSS	GND (0V)	2)
16	B2	Blue Data	
17	B1		
18	B0		
19	VSS	GND (0V)	2)
20	G5	Green Data	
21	G4		
22	G3		
23	VSS	GND (0V)	2)
24	G2	Green Data	
25	G1		
26	G0		
27	VSS	GND (0V)	2)
28	R5	Red Data	
29	R4		
30	R3		
31	VSS	GND (0V)	2)
32	R2	Red Data	
33	R1		
34	R0		
35	(IC)		3)
36	VSS	GND (0V)	2)
37	VSS		
38	DCLK	Dot Clock	
39	VSS	GND (0V)	2)
40	VSS		

- Notes
- 1) All VDD pins shall be connected to +3.3V(Typ.).
  - 2) All VSS pins shall be grounded. Metal bezel is internally connected to VSS.
  - 3) Keep open electrically. Hitachi test use only.
  - 4) Unconnected to the module

### 5.2 BACK-LIGHT UNIT

CN2 《S.T. ;BHR-03VS-1》

Pin No.	Symbol	Description	Note
1	VL	Power Supply	
2	NC	No connection	
3	GND	GND(0V)	

5.3 RELATIONSHIP BETWEEN DISPLAYED COLOR AND INPUT DATA

Color	Input	Red Data						Green Data						Blue Data					
		R5	R4	R3	R2	R1	R0	G5	G4	G3	G2	G1	G0	B5	B4	B3	B2	B1	B0
		MSB			LSB			MSB			LSB			MSB			LSB		
Basic Color	Black	0	0	0	0	0	0	0	0	0	0	0	0	0	0	0	0	0	0
	Red (0)	1	1	1	1	1	1	0	0	0	0	0	0	0	0	0	0	0	0
	Green (0)	0	0	0	0	0	0	1	1	1	1	1	1	0	0	0	0	0	0
	Blue (0)	0	0	0	0	0	0	0	0	0	0	0	0	1	1	1	1	1	1
	Cyan	0	0	0	0	0	0	1	1	1	1	1	1	1	1	1	1	1	1
	Magenta	1	1	1	1	1	1	0	0	0	0	0	0	1	1	1	1	1	1
	Yellow	1	1	1	1	1	1	1	1	1	1	1	1	0	0	0	0	0	0
	White	1	1	1	1	1	1	1	1	1	1	1	1	1	1	1	1	1	1
Red	Black	0	0	0	0	0	0	0	0	0	0	0	0	0	0	0	0	0	0
	Red (62)	0	0	0	0	0	1	0	0	0	0	0	0	0	0	0	0	0	0
	Red (61)	0	0	0	0	1	0	0	0	0	0	0	0	0	0	0	0	0	0
	:	:	:	:	:	:	:	:	:	:	:	:	:	:	:	:	:	:	:
	:	:	:	:	:	:	:	:	:	:	:	:	:	:	:	:	:	:	:
	Red (2)	1	1	1	1	0	1	0	0	0	0	0	0	0	0	0	0	0	0
	Red (1)	1	1	1	1	1	0	0	0	0	0	0	0	0	0	0	0	0	0
	Red (0)	1	1	1	1	1	1	0	0	0	0	0	0	0	0	0	0	0	0
Green	Black	0	0	0	0	0	0	0	0	0	0	0	0	0	0	0	0	0	0
	Green (62)	0	0	0	0	0	0	0	0	0	0	0	1	0	0	0	0	0	0
	Green (61)	0	0	0	0	0	0	0	0	0	0	1	0	0	0	0	0	0	0
	:	:	:	:	:	:	:	:	:	:	:	:	:	:	:	:	:	:	:
	:	:	:	:	:	:	:	:	:	:	:	:	:	:	:	:	:	:	:
	Green (2)	0	0	0	0	0	0	1	1	1	1	0	1	0	0	0	0	0	0
	Green (1)	0	0	0	0	0	0	1	1	1	1	1	0	0	0	0	0	0	0
	Green (0)	0	0	0	0	0	0	1	1	1	1	1	1	0	0	0	0	0	0
Blue	Black	0	0	0	0	0	0	0	0	0	0	0	0	0	0	0	0	0	0
	Blue (62)	0	0	0	0	0	0	0	0	0	0	0	0	0	0	0	0	0	1
	Blue (61)	0	0	0	0	0	0	0	0	0	0	0	0	0	0	0	0	1	0
	:	:	:	:	:	:	:	:	:	:	:	:	:	:	:	:	:	:	:
	:	:	:	:	:	:	:	:	:	:	:	:	:	:	:	:	:	:	:
	Blue (2)	0	0	0	0	0	0	0	0	0	0	0	0	1	1	1	1	0	1
	Blue (1)	0	0	0	0	0	0	0	0	0	0	0	0	1	1	1	1	1	0
	Blue (0)	0	0	0	0	0	0	0	0	0	0	0	0	1	1	1	1	1	1

Notes 1) Definition of gray scale:  
 Color(n) · · · · Number in parenthesis indicates gray scale level.  
 Higher n corresponds to darker level.

2) Data: 1:High, 0:Low

## 6. INTERFACE TIMING

### 6.1 TIMING CHART

(Data : Latched at Fall edge of DCLK)

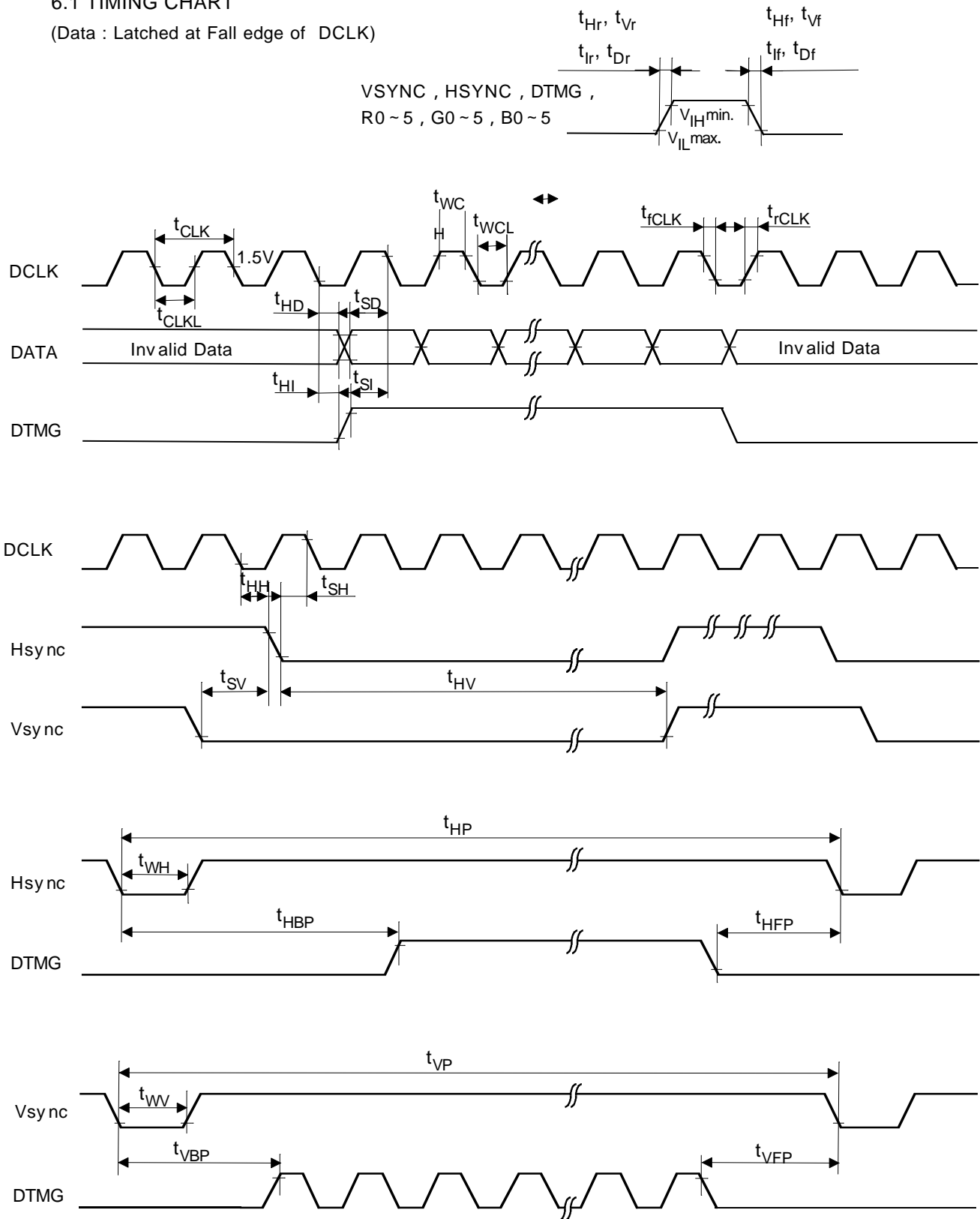

\* The DTMG signal for this module is defined as above-mentioned timings for Vsync and Hsync. This module synchronizes with only DTMG and don't require inputting Vsync and Hsync signals. During Blanking period, DTMG should be "Low" level

## 6.2 INTERFACE TIMING SPECIFICATIONS

	Item	Symbol	Min.	Typ.	Max.	Unit	Note
DCLK	Period	$t_{CLK}$	25	30	33	ns	
	Width-Low	$t_{WCL}$	12				
	Width-Hi	$t_{WCH}$	12				
	Rise Time	$t_{rCLK}$			25		
	Fall Time	$t_{fCLK}$			25		
	Duty	D	0.45	0.5	0.55		
Hsync	Set up Time	$t_{SH}$	5			ns	for DCLK
	Hold Time	$t_{HH}$	10				
	Period	$t_{HP}$	944	1056	1088	$t_{CLK}$	
	Width-Active	$t_{WH}$	4	128			
	Rise/Fall Time	$t_{Hr}, t_{Hf}$			30	ns	
Vsync	Set up Time	$t_{SV}$	0			$t_{CLK}$	for Hsync
	Hold Time	$t_{HV}$	2				
	Period	$t_{VP}$	515	525	610	$t_{HP}$	
	Width-Active	$t_{WV}$	1	2			
	Rise/Fall Time	$t_{Vr}, t_{Vf}$			50		
DTMG	Set up Time	$t_{SI}$	5			ns	for DCLK
	Hold Time	$t_{HI}$	10				
	Rise/Fall Time	$t_{Ir}, t_{If}$			30	ns	
	Horizontal Back porch	$t_{HBP}$	7	88		$t_{CLK}$	
	Horizontal Front porch	$t_{HFP}$		40			
	Vertical Back porch	$t_{VBP}$	4	32		$t_{HP}$	
	Vertical Front porch	$t_{VFP}$		11			
DATA	Set up Time	$t_{SD}$	5			ns	for DCLK
	Hold Time	$t_{HD}$	10				
	Rise/Fall Time	$t_{Dr}, t_{Df}$			25	ns	

### 6.3 TIMING BETWEEN INTERFACE SIGNAL AND POWER SUPPLY

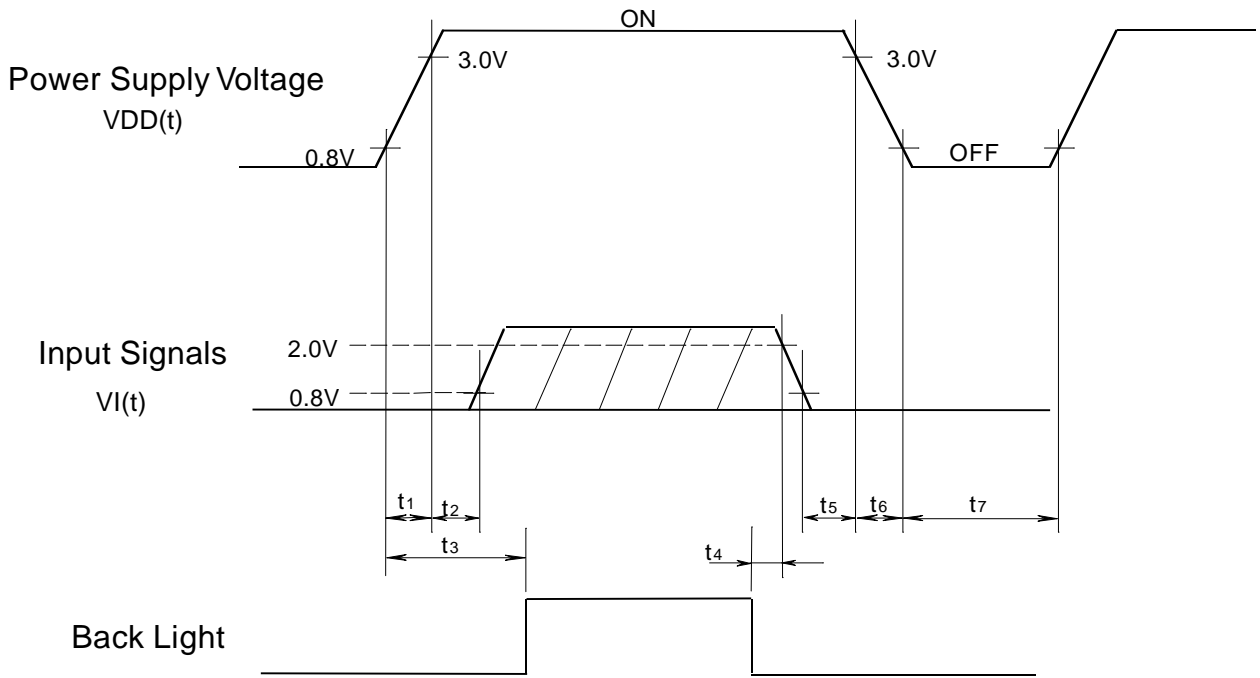

#### POWER ON

$t_1$  15ms  
 $0\text{ms} < t_2$  45ms  
 $0.1\text{s}$   $t_3$

#### POWER OFF

5ms  $t_4$   
 $0\text{ms}$   $t_5$  45ms  
 $0\text{ms}$   $t_6$  20ms  
 $0.4\text{s}$   $t_7$

Note 1) Set 0V  $V_I(t)$   $V_{DD}(t)$  .

Here,  $V_I(t)$ ,  $V_{DD}(t)$  indicate the transitional state of  $V_I$ ,  $V_{DD}$  when power supply is turned ON or OFF.

2) Do not keep interface signal high-impedance when power on.

# 7.DIMENSIONAL OUTLINE

## 7.1 Surface side

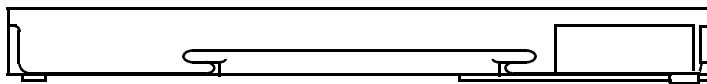
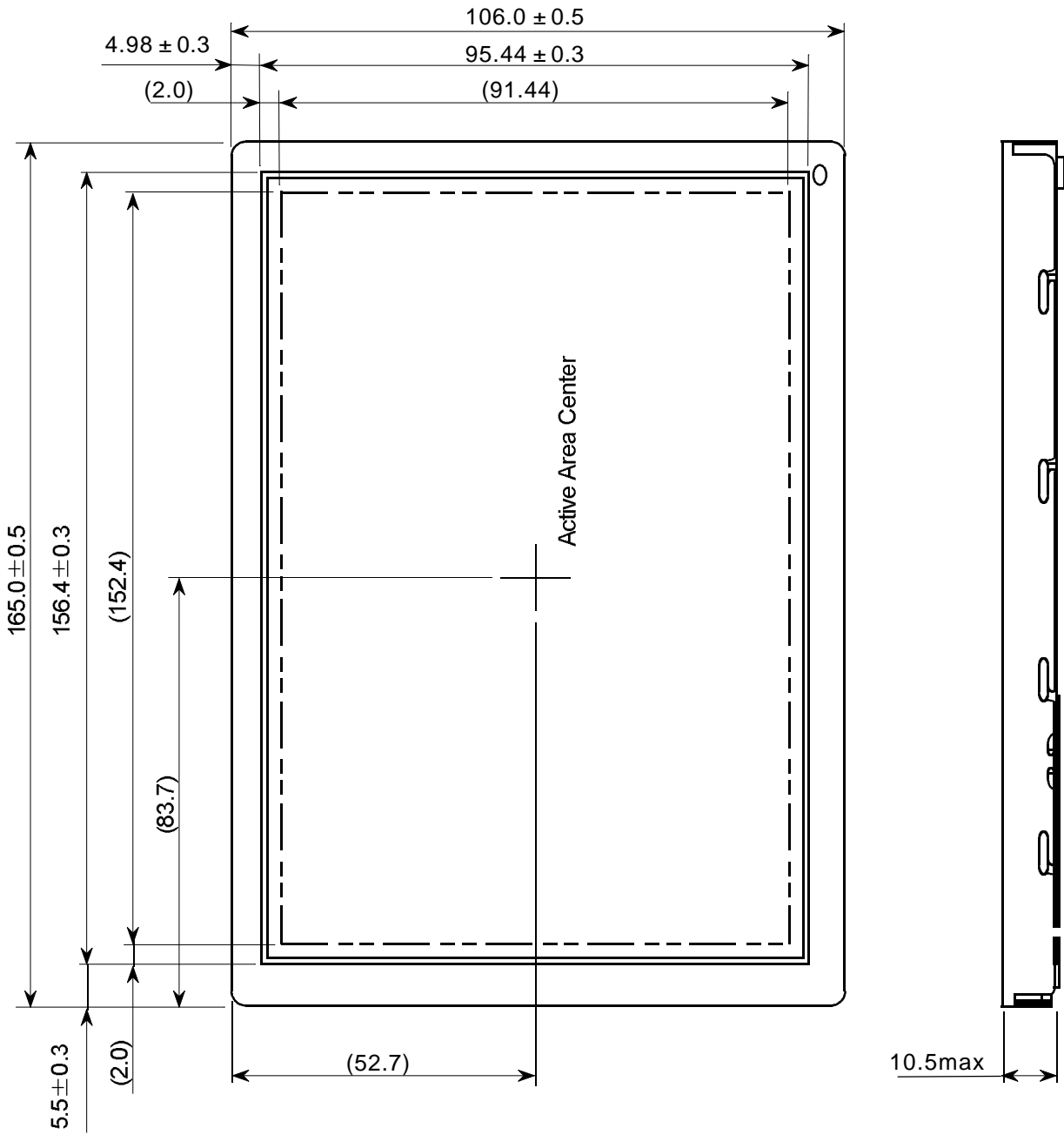

Unit:mm

7.2 Back side

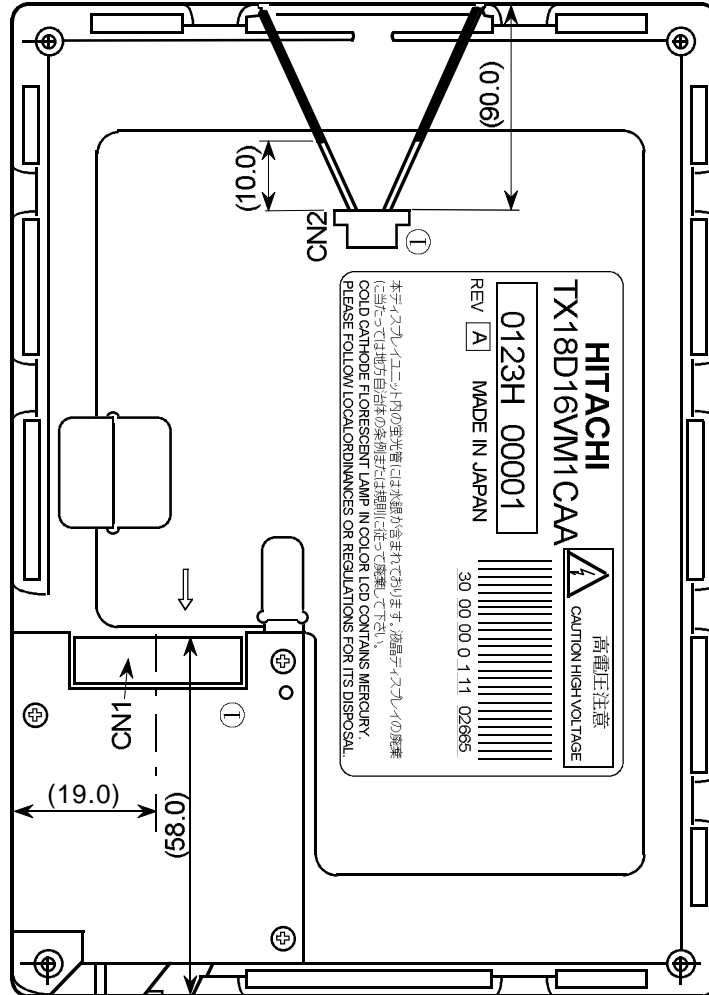

Note1)CN1:FA5B040HF1R3000(JAE)

2)CN2:BHR-03VS-1(JST)

Unit:mm

## 8. DESIGNATION OF LOT MARK

### 8.1 LOT MARK

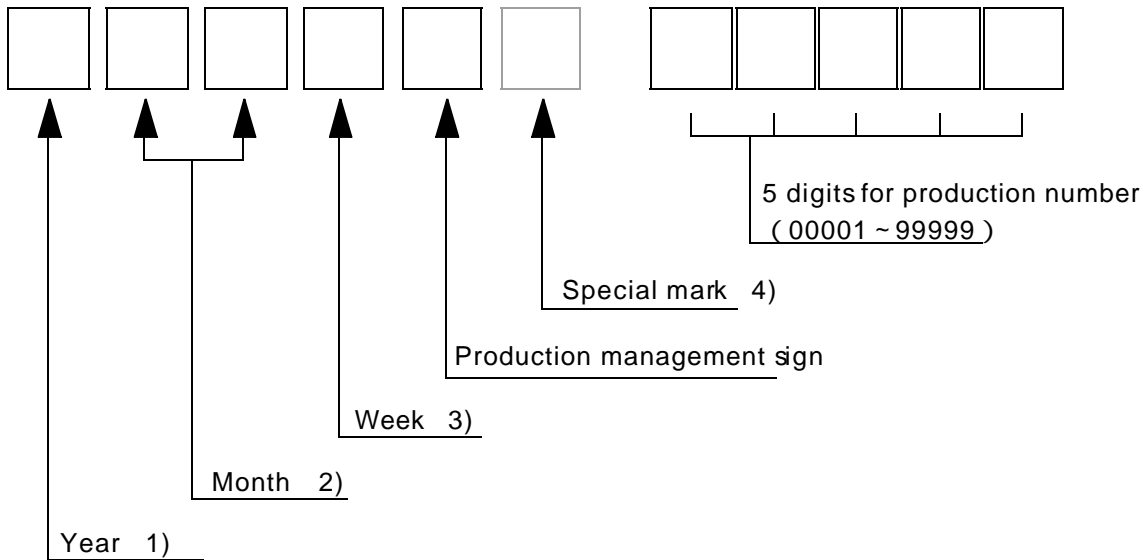

#### Notes

1)

Year	Mark
2003	3
2004	4
2005	5
2006	6
2007	7

2)

Month	Mark	Month	Mark
1	01	7	07
2	02	8	08
3	03	9	09
4	04	10	10
5	05	11	11
6	06	12	12

3)

Week ( Days )	Mark
1 ~ 7	1
8 ~ 14	2
15 ~ 21	3
22 ~ 28	4
29 ~ 31	5

4) The special mark may be added by manufacturing accordingly to production number.

### 8.2 REVISION(REV.) CONTROL

REV. column is controlled by the manufacturing. A-Z except I and O is to be written on this column.

### 8.3 LOCATION OF LOT MARK

Lot mark is printed on a label. The label is on rear side of module as shown in the drawing at Section 7. The style of character may be changed without notice.

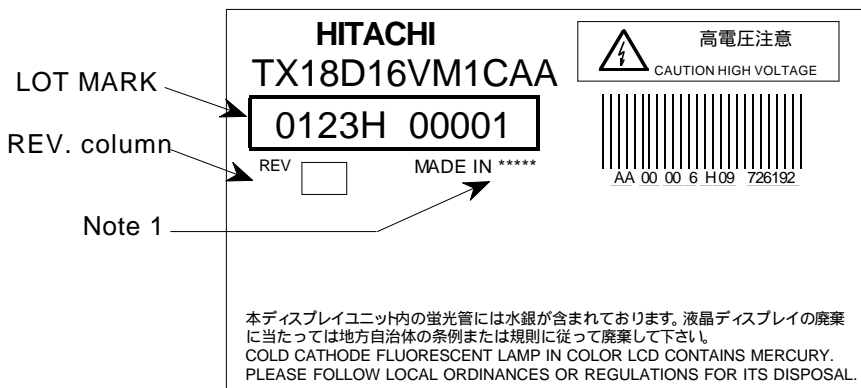

#### Note 1 Product Country

Product Country	Print on Label
JAPAN	JAPAN
TAIWAN	TAIWAN R.O.C.

Product Country on the Label shall be printed as shown in above Fig. based on product country.



## 8.4 Example of product label

### 8.4.1 Made in JAPAN



### 8.4.2 Made in TAIWAN R.O.C



## 9. COSMETIC SPECIFICATIONS

### 9.1 Condition for cosmetic inspection

#### (1) Viewing zone

a) The figure shows the correspondence between eyes (of inspector) and TFT-LCD module.

45° : when non-operating inspection

5° : when operating inspection

b) Inspection should be executed only from front side and only A-zone.  
Cosmetic of B-zone and C-zone are ignored.  
(refer to 9.2 Definition of zone)

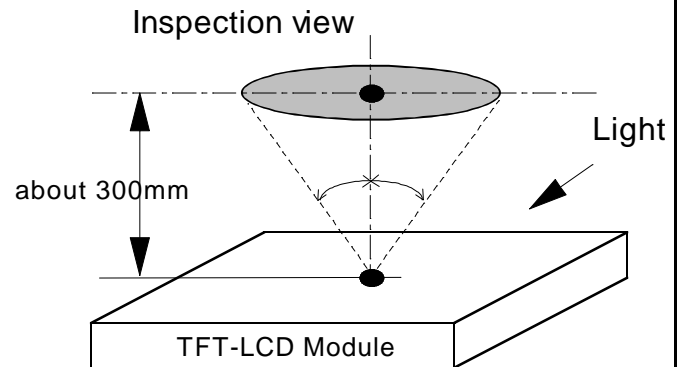

#### (2) Environmental

a) Temperature : 25 deg.C

The appearance inspection at Back-light on is done at 25 deg.C on a TFT-LCD panel.

b) Ambient light : More than 2000 [lx] and non-directive.

c) Back-light : when non-operating inspection, Back-light should be off.

#### (3) Operating inspection

Operating inspection should be done with 8 color mode (without gray scale).

### 9.2 Definition of zone

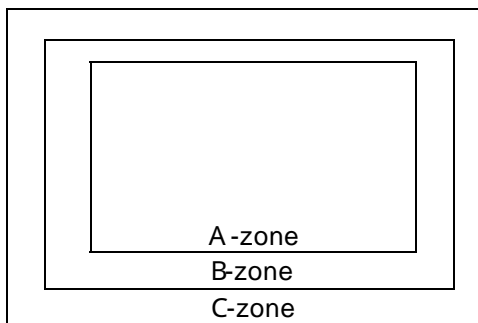

•A-zone : Display area (pixel area)

•B-zone : Area between A-zone and C-zone

•C-zone : Metallic bezel area (include I/F connector)

### 9.3 COSMETIC SPECIFICATIONS

When displaying conditions are not stable (ex. at turn on or off), the following specifications are not applied.

No.	ITEM			Max. acceptable number	Unit	Note	
				A-zone			
1	Dot defect	Sparkle mode	1-dot	4	pcs	1),2),4)	
			2-dots	1	Units	1),2),5)	
			3-dots	0			
			4-dots	0			
			Density	2			pcs/ 20mm
			Total	5	pcs	1),2)	
		Black mode	1-dot	5	pcs	1),3),4)	
			2-dots	2	Units	1),3),5)	
			3-dots	0			
			4-dots	0			
			Density	3			pcs/ 20mm
			Total	5	pcs	1),3)	
		Total			10	pcs	1)
		2	Line defect			Serious one is not allowed	-
3	Uneven brightness						
4	Strain inclusion Line shape W: width(mm) L: length(mm)	W<=0.02	L:Ignore	Ignore	pcs	7)	
		W<=0.03	L<=2.0	10			
			L>2.0	0			
		W<=0.06	L<=1.0	10			
			L>1.0	0			
W>0.06	-	(See dot shape)					
5	Strain inclusion Dot shape D: ave.dia(mm)	D<=0.22		Ignore	pcs	7)	
		D<=0.33		5			
		D>0.33		0			
6	Scratch on polarizer Line shape W: width(mm) L: length(mm)	W<=0.01	L:Ignore	Ignore	pcs	8)	
		W<=0.02	L<=40	10			
			L>40	0			
		W<=0.04	L<=20	10			
			L>20	0			
7	Scratch on polarizer Dot shape D: ave.dia(mm)	D<=0.2		Ignore	pcs	8)	
		D<=0.4		10			
		D>0.4		0			

No.	ITEM		Max. acceptable number	Unit	Note
			A-zone		
8	Bubbles, peeling in polarizer [ D: ave.dia(mm) ]	D≤0.3	Ignore	pcs	8)
		D≤0.5	10		
		D≤1.0	5		
		D>1.0	0		
9	Wrinkles on polarizer		Serious one is not allowed	-	-

- Note
- 1) Dot defect : defect area > 1/2 dot
  - 2) Sparkle mode : brightness of dot is more than 30% at black raster. (visible to eye)
  - 3) Black mode : brightness of dot is less than 70% at white raster. (visible to eye)
  - 4) 1 dot : defect dot is isolated, not attached to other defect dot.
  - 5) N dots : N defect dots are consecutive. (N means the number of defects dots)
  - 6) Density : number of defect dots inside 20mm .
  - 7) Those stains which can be wiped out easily are not defects.
  - 8) Polarizer area inside of B-zone is not applied.

## **10. PRECAUTION**

Please pay attention to the followings when you use this TFT-LCD Module with Back-light unit.

### 10.1 Precaution to handling and mounting

- (1) You should consider the mouting structure so that uneven force (ex. twisted stress) is not applied to the module.
- (2) To improve the strength of module against the mechanical shock the space between the module and the case should be less than 1.0mm.
- (3) Protection material in front of LCD's screen surface is recommended to protect a polarizer, LCD-glass and metal bezel. Please be note that the protection material should not touch them directry.
- (4) Acetic acid type and chloline type materials for the cover case are not desiable because the former generate corrosive gas of attacking the polarizer at high temperature and the latter causes circuit break by electro-chemical reaction.
- (5) Do not touch, push or rub the exposed polarizers with glass, tweezers or anything harder than HB pencil lead. And please do not rub by dustclothes with chemical treatment. Do not touch the surface of polarizer with bare hand or greasy close. (Some cosmetics are detrimental to the polarizer.)
- (6) When the surface becomes dusty, please wipe gently with absorbent cotton or other soft materials chamois soaked Normal-Hexane. Normal-Hexane is recommended for clearing the adhesives used to attach front /rear polarizers. Do not use acetone, toluen and alcohol because they cause chemical damage to the polarizer.
- (7) Wipe off saliva or water drops as soon as possible. Their long time contact with polarizer cuses deformations and color fading.
- (8) The module should never be opened or modified. It may cause not to operate properly.
- (9) Metallic bezel of a module should not be handled with bare hand or dirty gloves. Otherwise, color of a metallic frame may become dirty during its storage. It is recommended to use clean soft gloves and clean finger stalls when a module is handled at incoming inspection process and production (assembly) process.
- (10) When you adopt a metallic shield board on backside of TFT-LCD Module, it should not be too close to TFT-LCD Module.
- (11) Do not pull or do not fold the CCFL cable.

Hitachi Displays, Ltd.	Date	Sep.8,2003	Sheet No.	3284PS 2613-TX18D16VM1CAA-1	Page	13-1/4
------------------------	------	------------	-----------	-----------------------------	------	--------

## 10.2 Precaution to operation

- (1) You should adopt radiation structure to satisfy the temperature specification.
- (2) Optical response time, luminance and chromaticity depend on the temperature of a TFT-LCD module. (At lower temperature it becomes longer.)
- (3) Response time and saturation time of CCFL luminance become longer at lower temperature operation.
- (4) Sudden temperature change may cause dew on and/or in the a module. Dew males damage to a polarizer and/or electrical contacting portion. Dew causes fading of displayed quality.
- (5) Fixed patterns displayed on a module for a long time may cause after-image. It will be recovered soon.
- (6) Please connect the Back-light connector to the inverter circuit directly. The long cable between CCFL and the inverter may cause the brightness drop of CCFL and may cause the rise of starting lamp voltage(Vs).
- (8) The module should not be connected or removed while a main system works.
- (9) Inserting or pulling I/F connectors causes any truble when power supply and signal datas are on-state. I/F connectors should be inserted and pulled after power supply and signal datas are turned off.

## 10.3 Electrostatic discharge control

- (1) Since a module consists of a TFT cell and electronic circuits with CMOS-ICs, which are very weak to electrostatic discharge, persons who are handling a module should be grounded through adequate methods such as a list band. I/F connector pins should not be touched directly with bare hands.
- (2) Protection film for a polarizer on a module should be slowly peeled off so that the electrostatic charge can be minimized.

## 10.4 Precaution to strong light exposure

A module should not be exposed under strong light. Otherwise, characteristics of a polarizer and color filter in a module may be degraded.

## 10.5 Precaution to storage

When TFT-LCD Modules are stored for a long time, following precautions should be taken care of:

- (1) Modules should be stored in a dark place. It is prohibited to apply sunlight or fluorescent light during storage. Modules should be stored at 0 to 35°C at normal humidity (60%RH or less).
- (2) The surface of polarizers should not come in contact with any other object. It is recommended that modules should be stored in the Hitachi's shipping box.

## 10.6 Precaution to handle protective film

(1)When the protective film is peeled off, static electricity is generated between the film and the polarizer. This film should be peeled off slowly and carefully by people who are electrically grounded and with well ion-blown equipment or in such a condition, etc.

(2)The protective film is attached to the polarizer with a small amount of glue. If some stress is applied to rub the protective film against the polarizer during the time you peel off the film, the glue is apt to remain more on the polarizer. So please carefully peel off the protective film without rubbing it against the polarizer.

(3)When the module with protective film attached is stored for long time, sometimes there remains a very small amount of glue, still on the polarizer after the protective film is peeled off. Please refrain from storing the module at the high temperature and high humidity for glue is apt to remain in these condition.

(4)The glue may be taken for the modules failure, but you can remove the glue easily.

When the glue remains on the polarizer surface or its vestige is recognized, please wipe them off with absorbent cotton waste or other soft material like chamois soaked with Normal-Hexane.

## 10.7 Safety

(1) If module is broken, be careful to handle not to injure. (TFT-LCD and Lamp are made of glass.) Please wash hands sufficiently when you touch the liquid crystal coming out from broken LCDs.

(2)As Back-light unit has high voltage circuit internal, do not open the case and do not insert foreign materials in the case.

(3)The CCFL inverter should be designed to include the function of output shutdown in case the output overcurrent happen due to any backlight trouble. The shutdown function should be assured to work in abnormal condition at the actual systems.

#### 10.8 Environmental protection

- (1) This TFT-LCD Module include Cold Cathode Fluorescent Lamp (CCFL).  
CCFL contains a small amount of mercury. Please follow local ordinance or regulations for disposal.
- (2) Flexible circuits board, printed circuits board and solder used in a module contain small amount of lead (Pb). Please follow local ordinance or regulations for its disposal.

#### 10.9 Use restrictions and limitations

- (1) This product is not authorized for use in life support devices or systems, military applications or other applications which pose a significant risk of personal injury.
- (2) In no event shall Hitachi, Ltd., be liable for any incidental, indirect or consequential damages in connection with the installation or use of this product, even if informed of the possibility thereof in advance. These limitations apply to all causes of action in the aggregate, including without limitation breach of contract, breach of warranty, negligence, strict liability, misrepresentation and other torts.

#### 10.10 Others

- (1) Electrical components which may not affect electrical performance are subjective to change without notice because of their availability.

Hitachi Displays, Ltd.	Date	Sep.8,2003	Sheet No.	3284PS 2613-TX18D16VM1CAA-1	Page	13-4/4
------------------------	------	------------	-----------	-----------------------------	------	--------