

#### PROTECTION PRODUCTS - μClamp®

#### Description

μClamp® TVS diodes are designed to protect sensitive electronics from damage or latch-up due to EOS, lightning, CDE, and ESD. They feature large cross-sectional area junctions for conducting high transient currents. These devices offer desirable characteristics for board level protection including fast response time, low operating and clamping voltage, and no device degradation.

μClamp®3381P features extremely good protection characteristics highlighted by high surge current capability (25A,  $t_p=8/20\mu s$ ), low peak ESD clamping voltage, and high ESD withstand voltage ( $\pm 30kV$  contact per IEC 61000-4-2). Typical dynamic resistance is among the industry's best at 0.025 Ohms. Each device will protect one data or power line operating at 3.3 Volts.

μClamp3381P is in a 2-pin SGP1006N2 package measuring 1.0 x 0.6 x 0.5mm. Leads are spaced at a pitch of 0.65mm and feature a lead-free finish. The combination of small size, low operating voltage, and high ESD surge capability makes them ideal for protection of voltage bus lines in optical modules, LCD televisions, and tablet computers.

#### Features

- ◆ Transient protection for VBus and data lines to IEC 61000-4-2 (ESD)  $\pm 30kV$  (air),  $\pm 30kV$  (contact)
- IEC 61000-4-4 (EFT) 40A (5/50ns)
- IEC 61000-4-5 (Lightning) 25A (8/20 $\mu s$ )
- ◆ Protects one line
- ◆ Low ESD clamping voltage
- ◆ Working voltage: 3.3V
- ◆ Low leakage current
- ◆ Extremely low dynamic resistance: 0.025 Ohms (Typ)
- ◆ Solid-state silicon-avalanche technology

#### Mechanical Characteristics

- ◆ SGP1006N2 package
- ◆ Pb-Free, Halogen Free, RoHS/WEEE Compliant
- ◆ Nominal Dimensions: 1.0 x 0.6 x 0.50 mm
- ◆ Lead Finish: NiPdAu
- ◆ Marking: Marking code
- ◆ Packaging: Tape and Reel

#### Applications

- ◆ Optical Modules
- ◆ 3.3V VBus Protection
- ◆ LCD TV
- ◆ Tablet PC
- ◆ Instrumentation
- ◆ CCTV Cameras

#### Package Dimensions

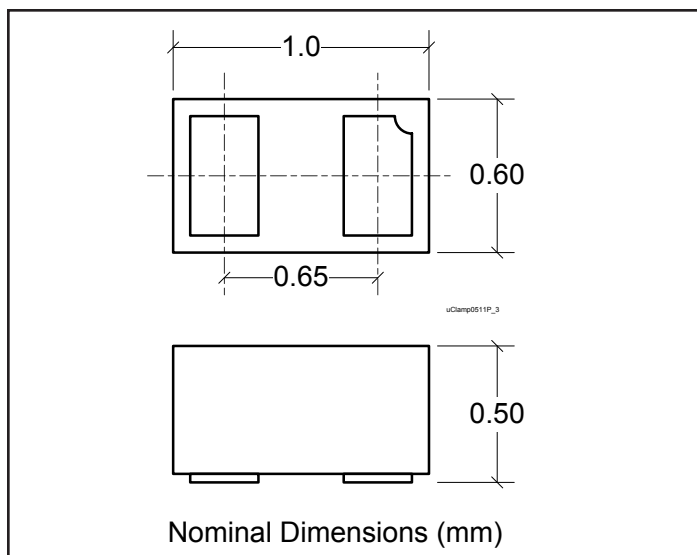

#### Schematic & Pin Configuration

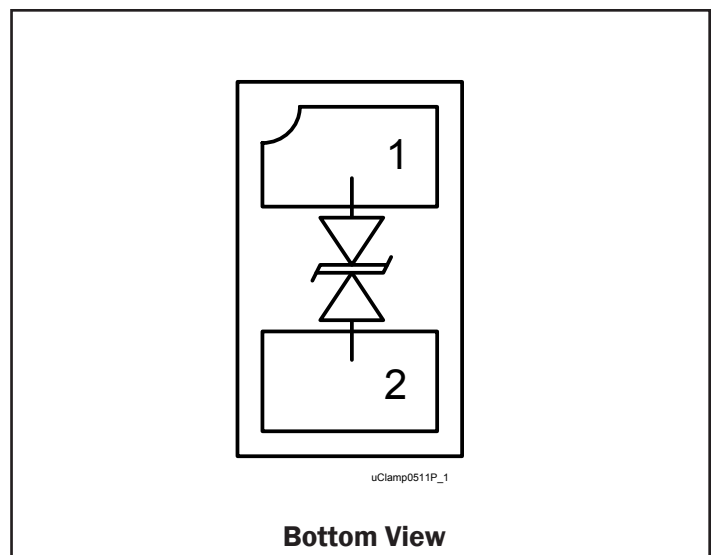

PROTECTION PRODUCTS

Absolute Maximum Ratings

| Rating   | Symbol           | Value       | Units |
|--|------------------|-------------|-------|
| Peak Pulse Power (tp = 8/20μs)   | P <sub>PK</sub>  | 275         | W     |
| Peak Pulse Current (tp = 8/20μs)   | I <sub>PP</sub>  | 25          | A     |
| ESD per IEC 61000-4-2 (Air) <sup>(1)</sup><br>ESD per IEC 61000-4-2 (Contact) <sup>(1)</sup> | V <sub>ESD</sub> | ±30<br>±30  | kV    |
| Operating Temperature  | T <sub>J</sub>   | -40 to +125 | °C    |
| Storage Temperature  | T <sub>STG</sub> | -55 to +150 | °C    |

Electrical Characteristics (T=25°C unless otherwise specified)

| Parameter                         | Symbol           | Conditions  | Min. | Typ.  | Max. | Units |
|-----------------------------------|------------------|---|------|-------|------|-------|
| Reverse Stand-Off Voltage         | V <sub>RWM</sub> | Pin 1 to 2 or Pin 2 to 1                            |      |       | 3.3  | V     |
| Reverse breakdown Voltage         | V <sub>BR</sub>  | I <sub>BR</sub> = 1mA<br>Pin 1 to 2 or Pin 2 to 1   | 4.5  | 8.5   | 10   | V     |
| Reverse Leakage Current           | I <sub>R</sub>   | V <sub>RWM</sub> = 3.3V<br>Pin 1 to 2 or Pin 2 to 1 |      | 1     | 100  | nA    |
| Clamping Voltage                  | V <sub>C</sub>   | I <sub>PP</sub> = 25A, tp = 8/20μs                  |      |       | 11.5 | V     |
| ESD Clamping Voltage <sup>2</sup> | V <sub>C</sub>   | I <sub>PP</sub> = 4A<br>tp = 0.2/100ns              |      | 8.3   |      | V     |
| ESD Clamping Voltage <sup>2</sup> | V <sub>C</sub>   | I <sub>PP</sub> = 16A<br>tp = 0.2/100ns             |      | 8     |      | V     |
| Dynamic Resistance <sup>2,3</sup> | R <sub>DYN</sub> | tp = 100ns  |      | 0.025 |      | Ohms  |
| Junction Capacitance              | C <sub>J</sub>   | I/O pin to GND<br>f = 1MHz                          |      | 30    | 35   | pF    |

- Notes
- 1) Measured with a 20dB attenuator, 50 Ohm scope input impedance, 2GHz bandwidth. ESD gun return path connected to ESD ground plane.
  - 2) Transmission Line Pulse Test (TLP) Settings: tp = 100ns, tr = 0.2ns, I<sub>TLP</sub> and V<sub>TLP</sub> averaging window: t1 = 70ns to t2 = 90ns.
  - 3) Dynamic resistance calculated from I<sub>TLP</sub> = 4A to I<sub>TLP</sub> = 16A

PROTECTION PRODUCTS

Typical Characteristics

Non-Repetitive Peak Pulse Power vs. Pulse Time

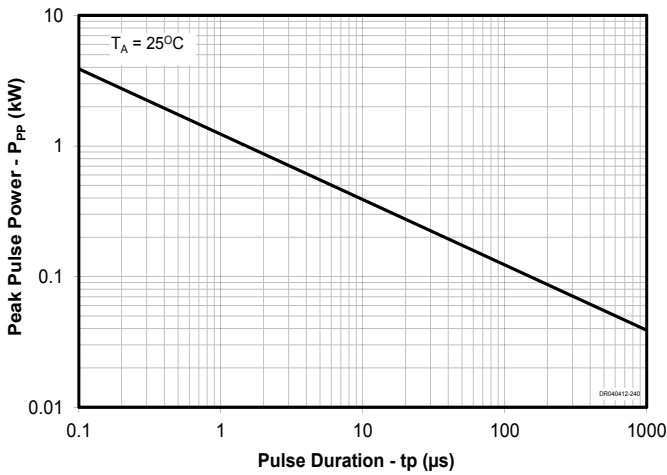

Clamping Voltage vs. Peak Pulse Current ( $t_p=8/20\mu$ s)

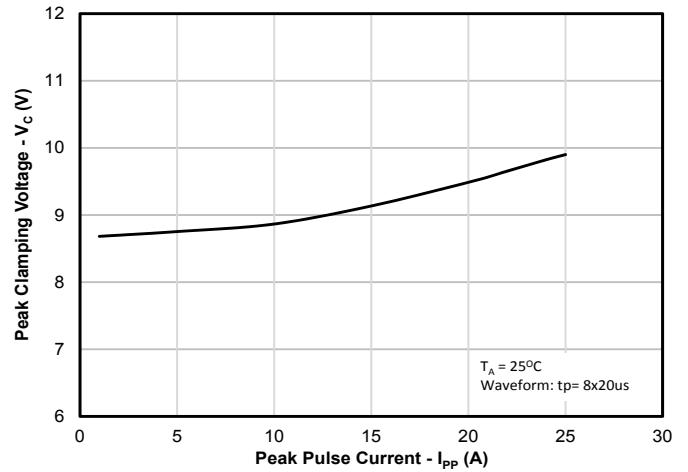

TLP Characteristic

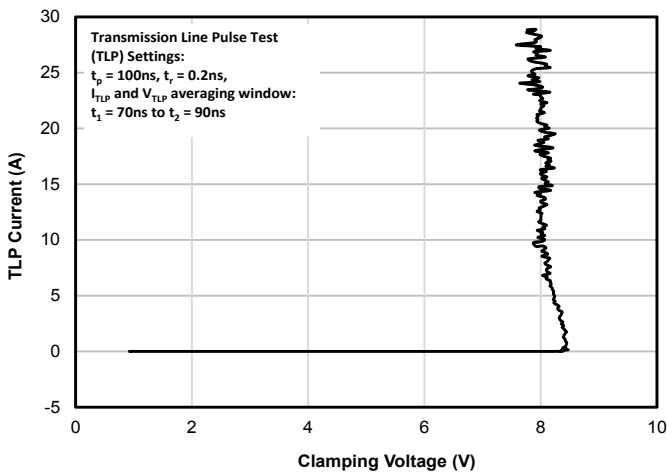

Typical Breakdown Voltage vs. Temperature

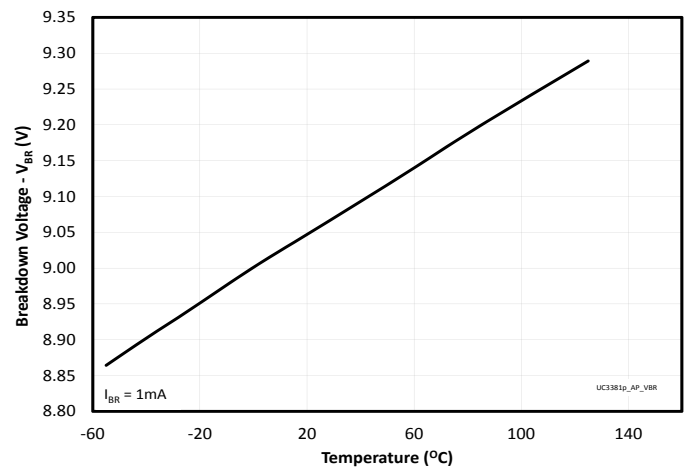

ESD Clamping (8kV Contact per IEC 61000-4-2)

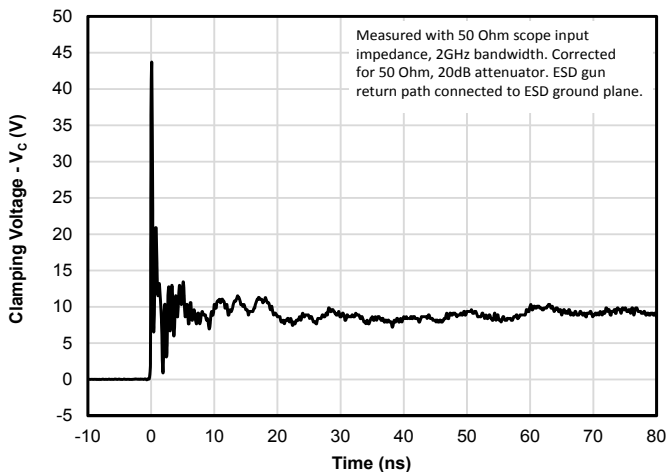

ESD Clamping (-8kV Contact per IEC 61000-4-2)

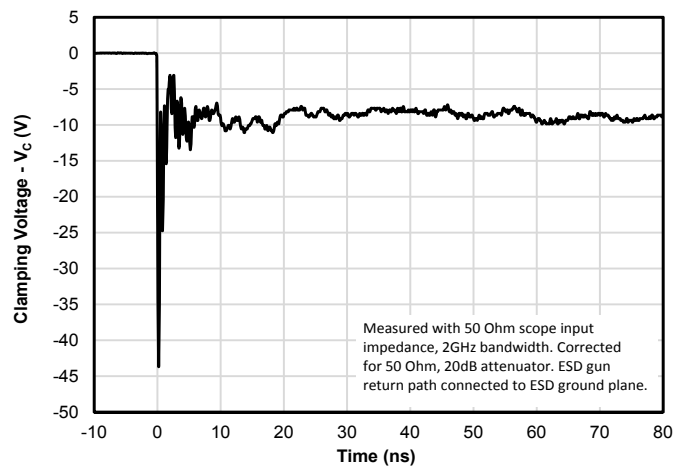

PROTECTION PRODUCTS

Outline Drawing - SGP1006N2

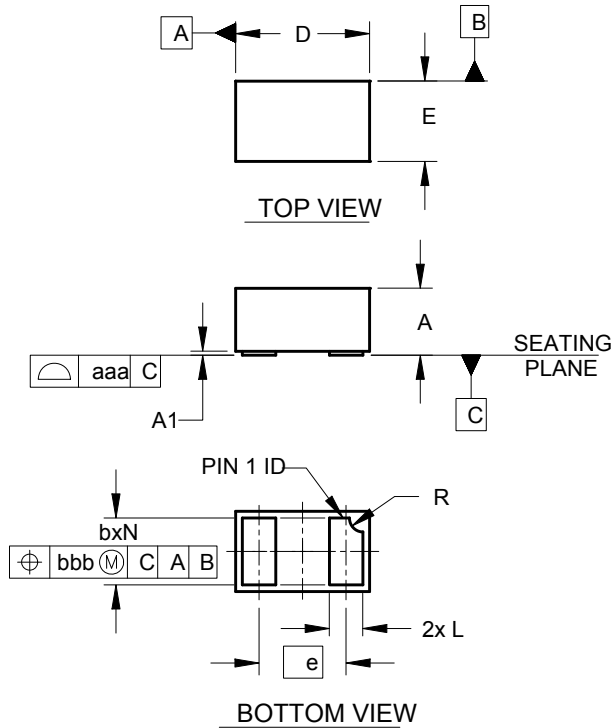

| DIM | INCHES   |      |      | MILLIMETERS |      |      |
|-----|----------|------|------|-------------|------|------|
|     | MIN      | NOM  | MAX  | MIN         | NOM  | MAX  |
| A   | .016     | .020 | .022 | 0.40        | 0.50 | 0.55 |
| A1  | .000     | .001 | .002 | 0.00        | 0.03 | 0.05 |
| b   | .018     | .020 | .022 | 0.45        | 0.50 | 0.55 |
| D   | .035     | .039 | .043 | 0.90        | 1.00 | 1.10 |
| E   | .020     | .024 | .028 | 0.50        | 0.60 | 0.70 |
| e   | .026 BSC |      |      | 0.65 BSC    |      |      |
| L   | .008     | .010 | .012 | 0.20        | 0.25 | 0.30 |
| R   | .002     | .004 | .006 | 0.05        | 0.10 | 0.15 |
| N   | 2        |      |      | 2           |      |      |
| aaa | .003     |      |      | 0.08        |      |      |
| bbb | .004     |      |      | 0.10        |      |      |

SLP1006P2-1-R0

NOTES:

1. CONTROLLING DIMENSIONS ARE IN MILLIMETERS (ANGLES IN DEGREES).

Land Pattern - SGP1006N2

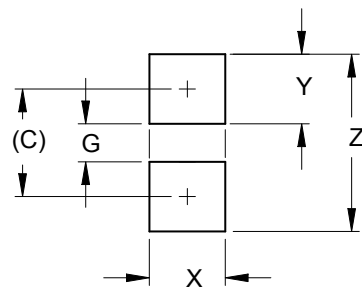

| DIM | DIMENSIONS |             |
|-----|------------|-------------|
|     | INCHES     | MILLIMETERS |
| C   | (.033)     | (0.85)      |
| G   | .012       | 0.30        |
| X   | .024       | 0.60        |
| Y   | .022       | 0.55        |
| Z   | .055       | 1.40        |

SLP1006P2-2-R0

NOTES:

1. CONTROLLING DIMENSIONS ARE IN MILLIMETERS (ANGLES IN DEGREES).
2. THIS LAND PATTERN IS FOR REFERENCE PURPOSES ONLY. CONSULT YOUR MANUFACTURING GROUP TO ENSURE YOUR COMPANY'S MANUFACTURING GUIDELINES ARE MET.

## PROTECTION PRODUCTS

### Marking

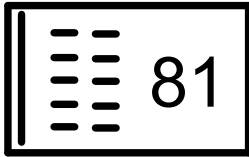

Notes: Device is Electrically Symmetrical

### Ordering Information

| Part Number     | Qty per Reel | Reel Size |
|-----------------|--------------|-----------|
| μClamp3381P.TFT | 15000        | 7"        |

Notes:

1) MicroClamp, uClamp and μClamp are trademarks of Semtech Corporation.

### Tape and Reel Specification

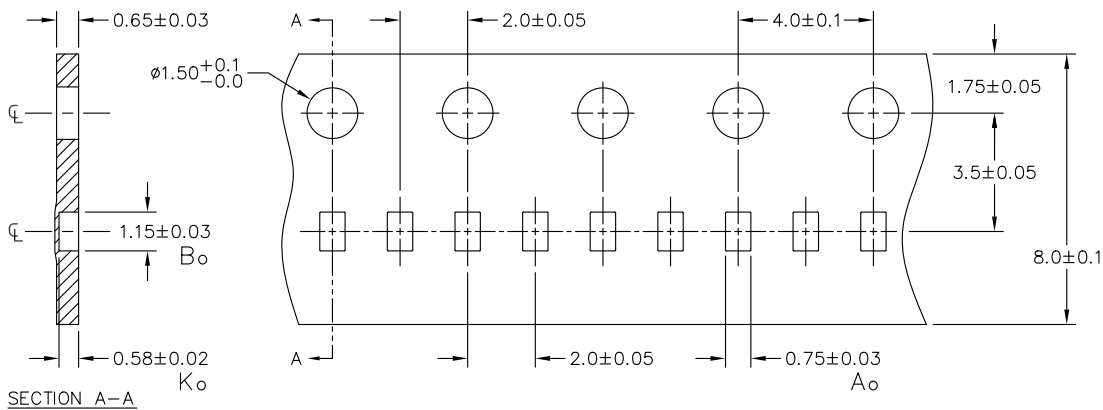

NOTES: ALL DIMENSIONS IN MILLIMETERS UNLESS OTHERWISE SPECIFIED.

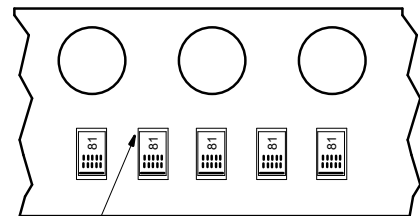

Marking Code Location  
(Towards Sprocket Holes)

### Contact Information

Semtech Corporation  
 Protection Products Division  
 200 Flynn Rd., Camarillo, CA 93012  
 Phone: (805)498-2111 FAX (805)498-3804