

## Features

- 802.11a,n,ac Applications
- 0.9 dB  $T_X$  Insertion Loss
- 19 dB  $R_X$  Isolation
- 12 dB  $R_X$  Gain
- 2.2 dB Noise Figure
- 10 mA Current
- -40 dB EVM @ 23 dBm Input (802.11ac 80 MHz / 256 QAM)
- Lead Free 2 mm 12-lead STQFN package
- RoHS\* Compliant and 260°C Reflow Compatible

## Description

The MAMF-010614 is a multi-function MMIC which includes a SPDT switch and LNA with bypass mode for the  $R_X$  path. This part would typically be used on the front end of WLAN 802.11a,n,ac modules where small size is critical.

The MAMF-010614 delivers high isolation between  $T_X$  and  $R_X$  paths, low  $T_X$  insertion loss and a high gain, low noise  $R_X$  path.

## Functional Schematic

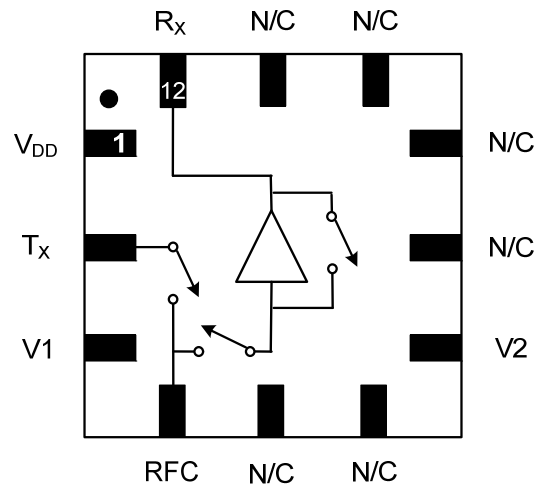

## Pin Configuration<sup>3</sup>

Pin No.	Function	Description
1	$V_{DD}$	Drain Voltage Supply
2	$T_X$	$T_X$ Port
3	V1	Control 1
4	RFC	RF Common
5	N/C	No Connection
6	N/C	No Connection
7	V2	Control 2
8	N/C	No Connection
9	N/C	No Connection
10	N/C	No Connection
11	N/C	No Connection
12	$R_X$	$R_X$ Port
13	Paddle <sup>4</sup>	Ground

3. M/A-COM Technology Solutions recommends connecting unused package pins to ground.
4. The exposed pad centered on the package bottom must be connected to RF and DC ground.

## Ordering Information<sup>1,2</sup>

Part Number	Package
MAMF-010614-TR3000	3000 piece reel
MAMF-010614-001SMB	Sample Board

1. Reference Application Note M513 for reel size information.
2. All sample boards include 5 loose parts.

\* Restrictions on Hazardous Substances, European Union Directive 2002/95/EC.

## Integrated SPDT Switch and LNA with Bypass Mode 5.0 - 6.0 GHz

Rev. V3

### Electrical Specifications: Freq. = 5.25 - 5.825 GHz, $V_{DD} = 3\text{ V}$ , $V_C = 0/2.8\text{ V}$ , $T_A = 25^\circ\text{C}$

Parameter	Test Conditions	Units	Min.	Typ.	Max.
Isolation	RFC to $T_X$ RFC to $R_X$	dB	—	19 19	— —
$T_X$ Insertion Loss	RFC to $T_X$	dB	—	0.9	1.2
$T_X$ Input / Output Return Loss	RFC to $T_X$	dB	—	12	—
$T_X$ Input P0.1dB	$T_X$ Path On	dBm	—	31	—
$T_X$ EVM	$P_{IN} = +23\text{ dBm}$ , 802.11AC 80 MHz / 256 QAM	dB	—	-42	—
$R_X$ Gain	RFC to $R_X$ , Gain Mode	dB	10	12	—
$R_X$ Insertion Loss	RFC to $R_X$ , Bypass Mode	dB	—	6	7.5
$R_X$ Input / Output Return Loss	RFC to $R_X$ , Gain Mode	dB	—	10	—
$R_X$ Noise Figure	Gain Mode	dB	—	2.2	—
$R_X$ Input IP3	Gain Mode	dBm	—	10	—
$R_X$ Input P0.1dB	Bypass Mode	dBm	—	10	—
$R_X$ Input P1dB	Gain Mode	dBm	-5	-3	—
$R_X$ EVM	$P_{IN} = -15\text{ dBm}$ , Gain Mode	dB	—	-46	—
Quiescent Current	No RF, Gain Mode, $V_{DD} = 3\text{ V}$	mA	—	10	12
Leakage Current	All States except High Gain	$\mu\text{A}$	—	10	—

### Absolute Maximum Ratings<sup>5,6</sup>

Parameter	Absolute Maximum
Input Power $R_X$ Gain Mode $R_X$ Bypass Mode $T_X$ , 5 $V_C$ , RFC - $T_X$ $T_X$ , 3.3 $V_C$ , RFC - $T_X$	0 dBm 20 dBm 35 dBm CW 33 dBm CW
$V_{DD}$	+5 volts
Operating Temperature	-40°C to +85°C
Storage Temperature	-65°C to +150°C

5. Exceeding any one or combination of these limits may cause permanent damage to this device.  
6. M/A-COM Technology Solutions does not recommend sustained operation near these survivability limits.

### Truth Table<sup>7,8</sup>

Control V1	Control V2	RFC- $R_X$	RFC- $T_X$
Low	Low	Bypass Mode	Off
Hi	Low	Gain Mode	Off
Low	Hi	Off	On

7. Differential voltage, V (state Low) - V (state Hi), must be +2.7 V minimum and must not exceed +5 V.  
8. Low =  $0 \pm 0.3\text{ V}$ , Hi = +2.7 V to +5 V.

## Typical Performance Curves:

**R<sub>x</sub> Insertion Loss, Bypass Mode**

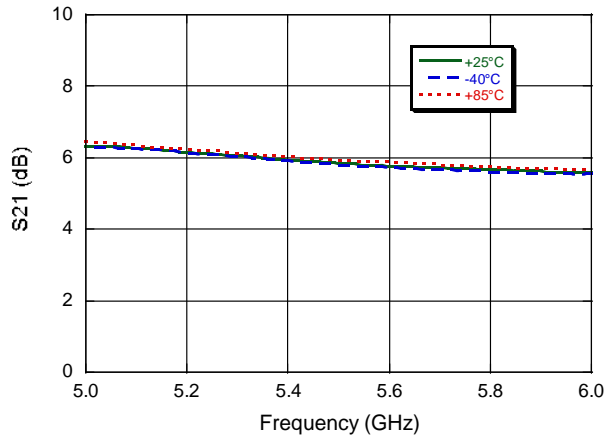

**R<sub>x</sub> Gain, Gain Mode**

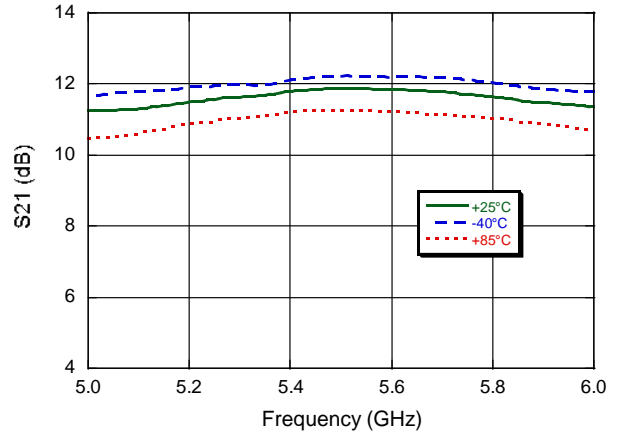

**RFC - R<sub>x</sub> Isolation (T<sub>x</sub> On)**

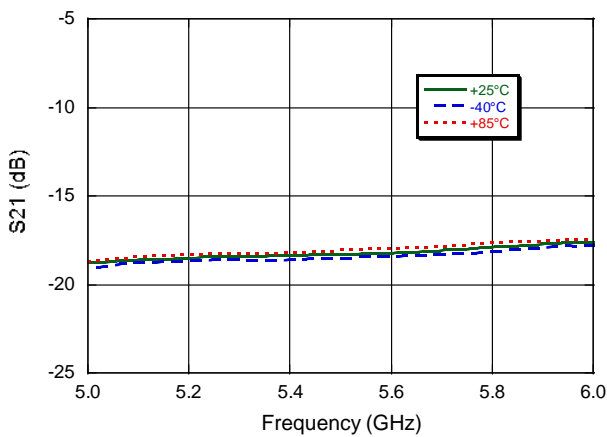

**R<sub>x</sub> Noise Figure, Gain Mode**

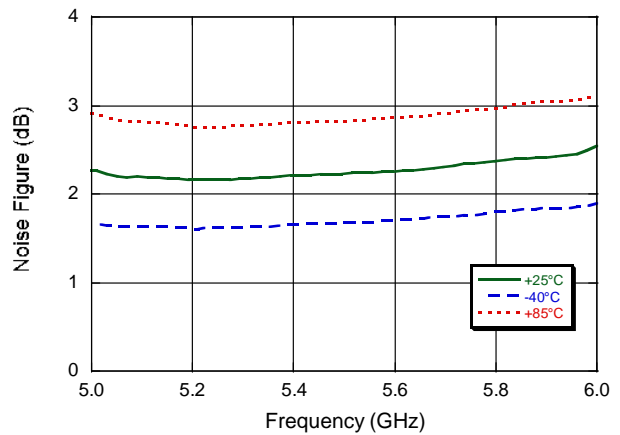

## Typical Performance Curves:

**R<sub>x</sub> Input Return Loss, Bypass Mode**

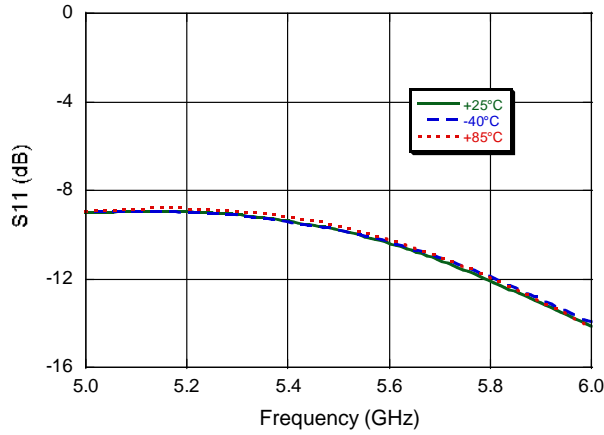

**R<sub>x</sub> Input Return Loss, Gain Mode**

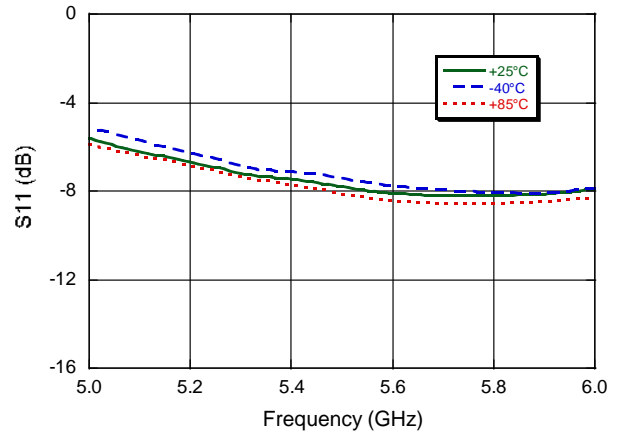

**R<sub>x</sub> Output Return Loss, Bypass Mode**

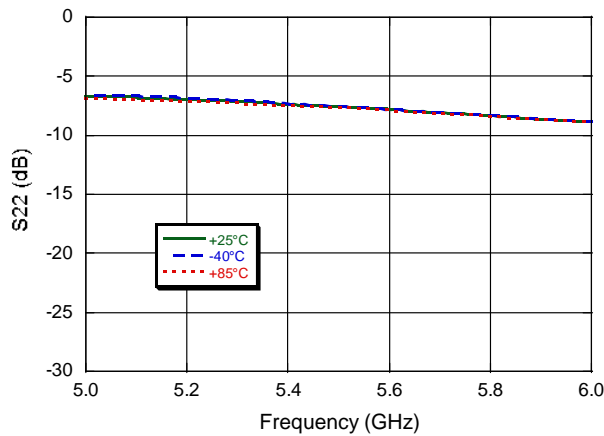

**R<sub>x</sub> Output Return Loss, Gain Mode**

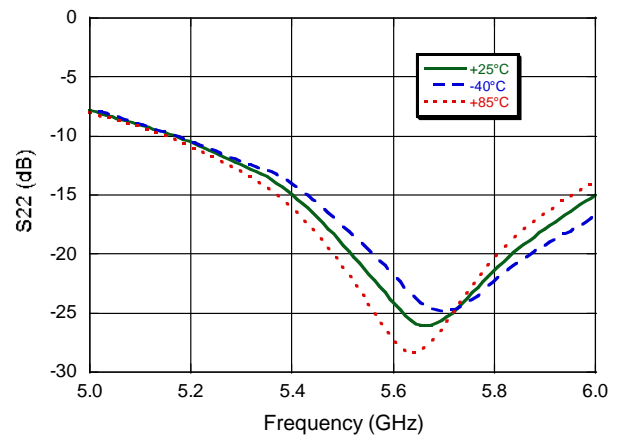

### Typical Performance Curves:

**R<sub>x</sub> Input IP<sub>3</sub>, Gain Mode @ +25°C**

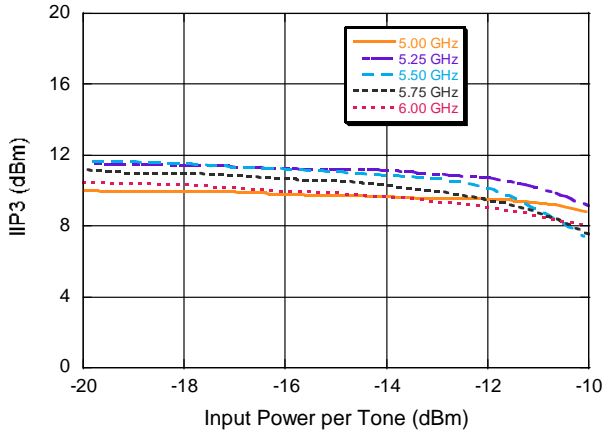

**R<sub>x</sub> Input IP<sub>3</sub>, Bypass Mode @ +25°C**

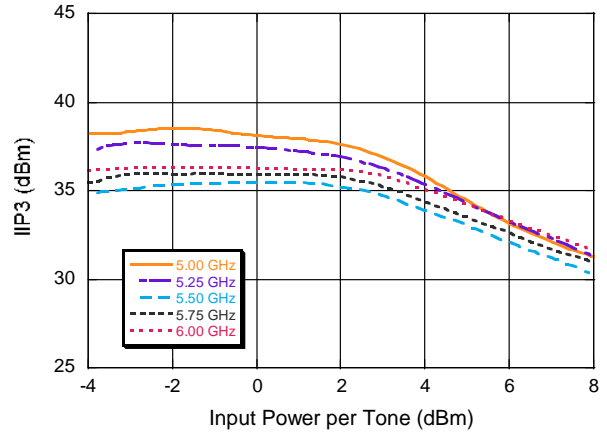

**R<sub>x</sub> Input IP<sub>3</sub>, Gain Mode @ -40°C**

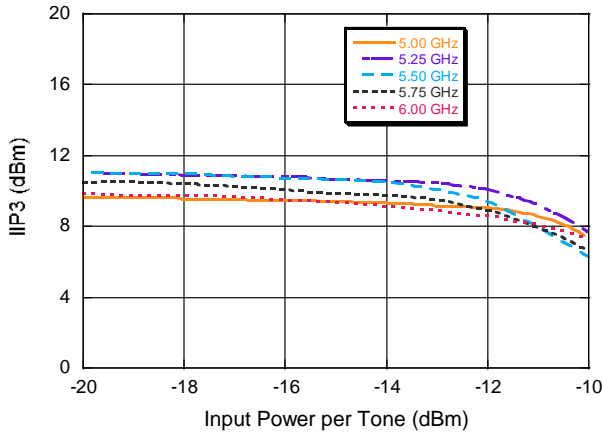

**R<sub>x</sub> Input IP<sub>3</sub>, Bypass Mode @ -40°C**

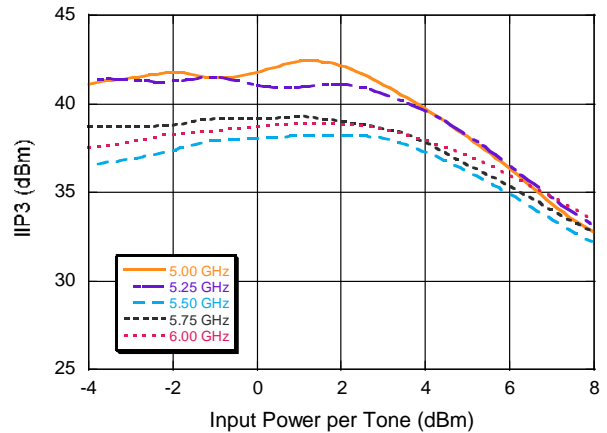

**R<sub>x</sub> Input IP<sub>3</sub>, Gain Mode @ +85°C**

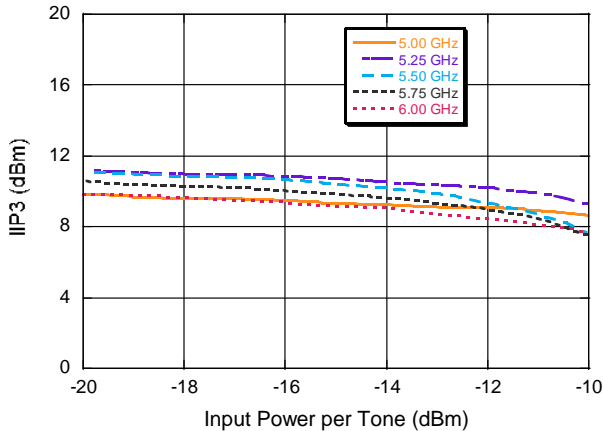

**R<sub>x</sub> Input IP<sub>3</sub>, Bypass Mode @ +85°C**

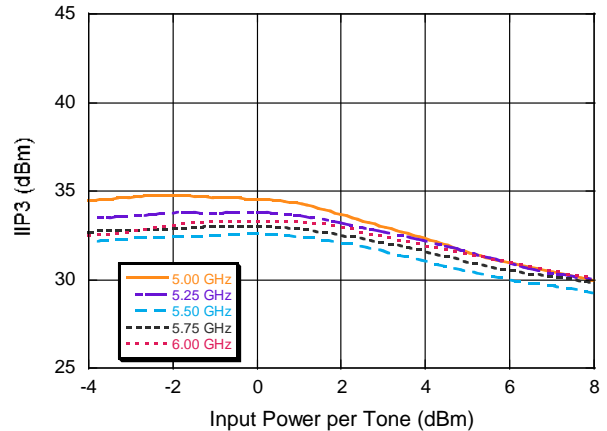

## Typical Performance Curves:

$T_x$  Input Return Loss

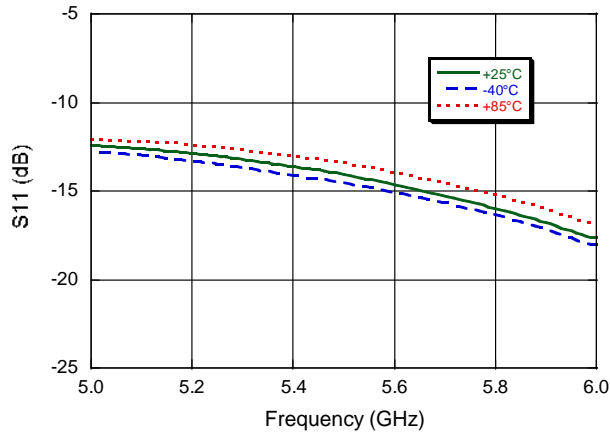

$T_x$  Output Return Loss

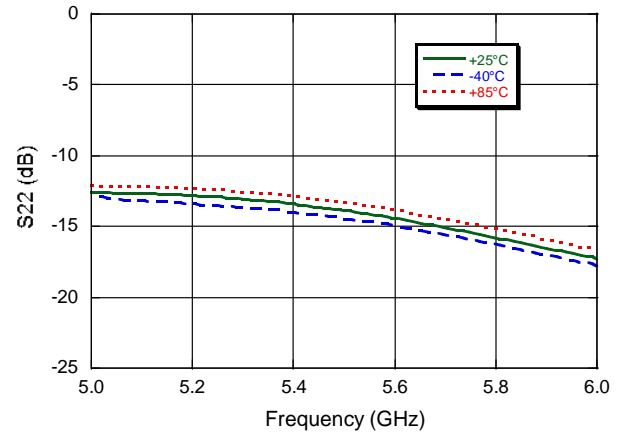

$T_x$  Insertion Loss

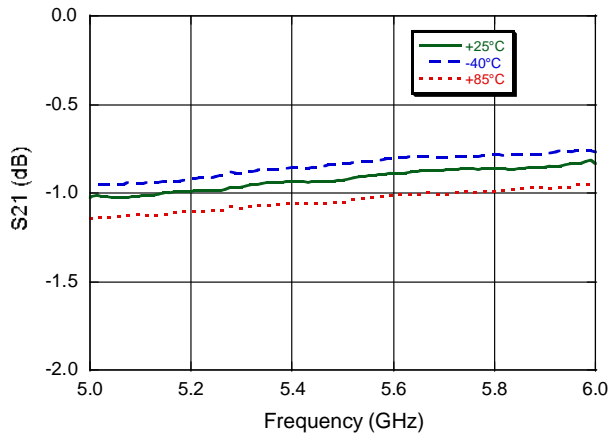

$T_x - R_x$  Isolation

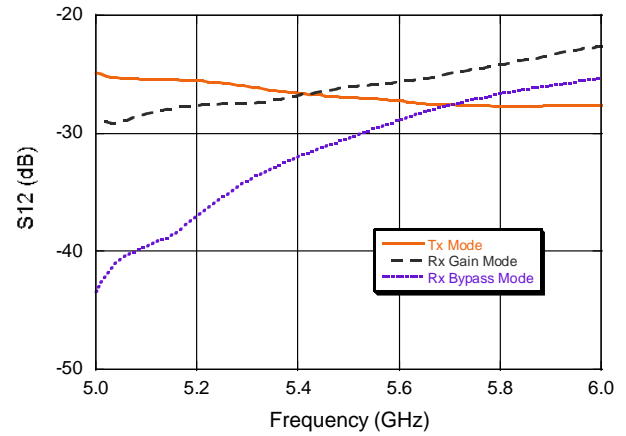

## Typical Performance Curves:

$T_x$  Input IP3 @ +25°C

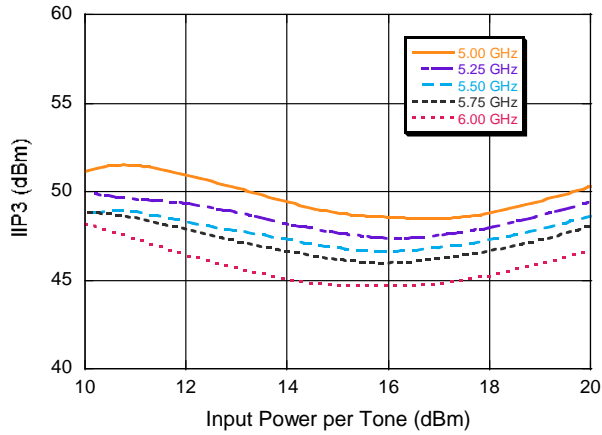

$T_x$  Input IP3 @ -40°C

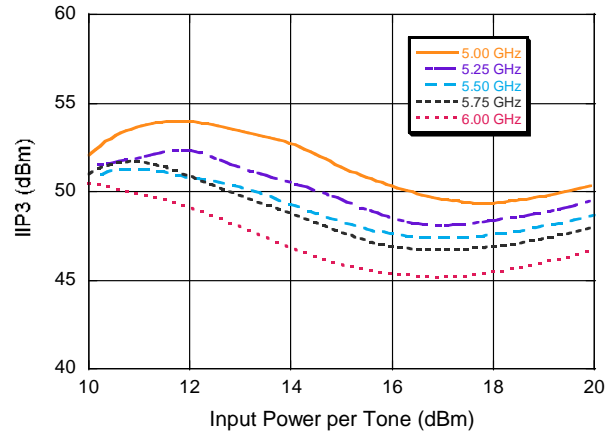

$T_x$  Input IP3 @ +85°C

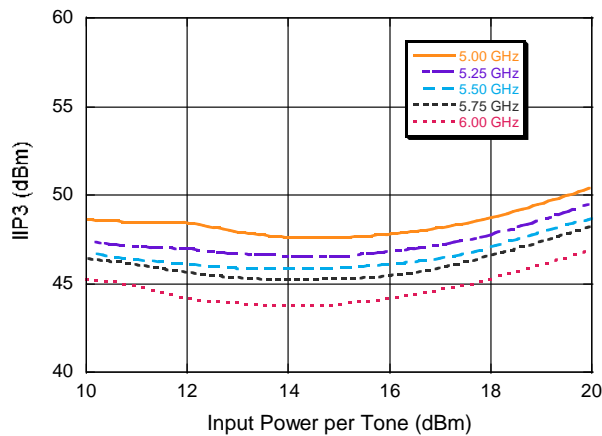

$T_x$  Output IP3 @ +25°C

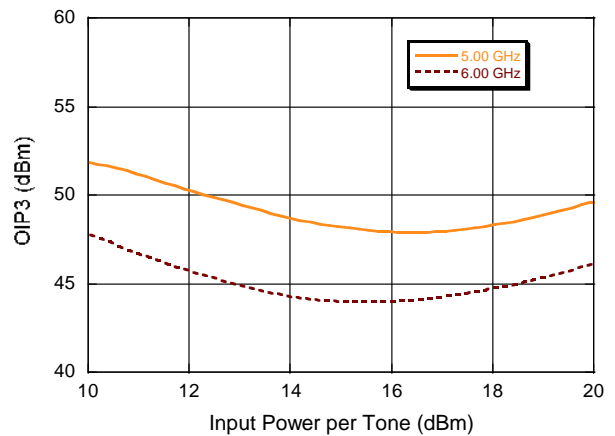

## Recommended Sample Board<sup>9</sup>

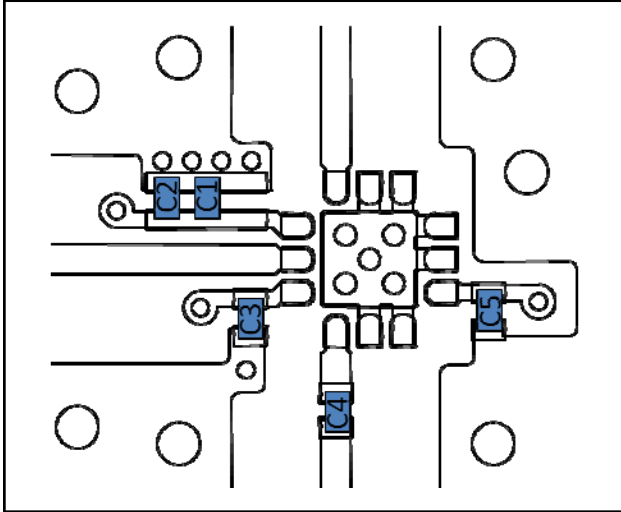

9. Place C1 and C2 as shown.

## Functional Schematic

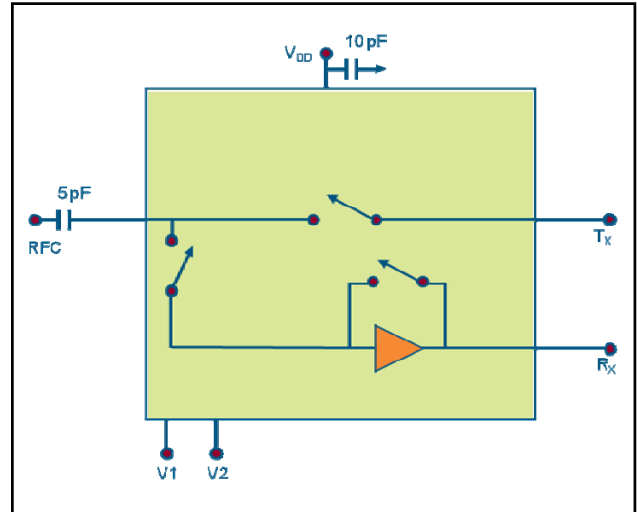

## Parts List

Component	Value	Case Size
C1	10 pF	0201
C2, C3, C5	0.1 $\mu$ F	0201
C4	5 pF	0201

## Handling Procedures

Please observe the following precautions to avoid damage:

## Static Sensitivity

Gallium Arsenide Integrated Circuits are sensitive to electrostatic discharge (ESD) and can be damaged by static electricity. Proper ESD control techniques should be used when handling these devices.

## System Compensated EVM, 802.11AC 80 MHz / 256 QAM

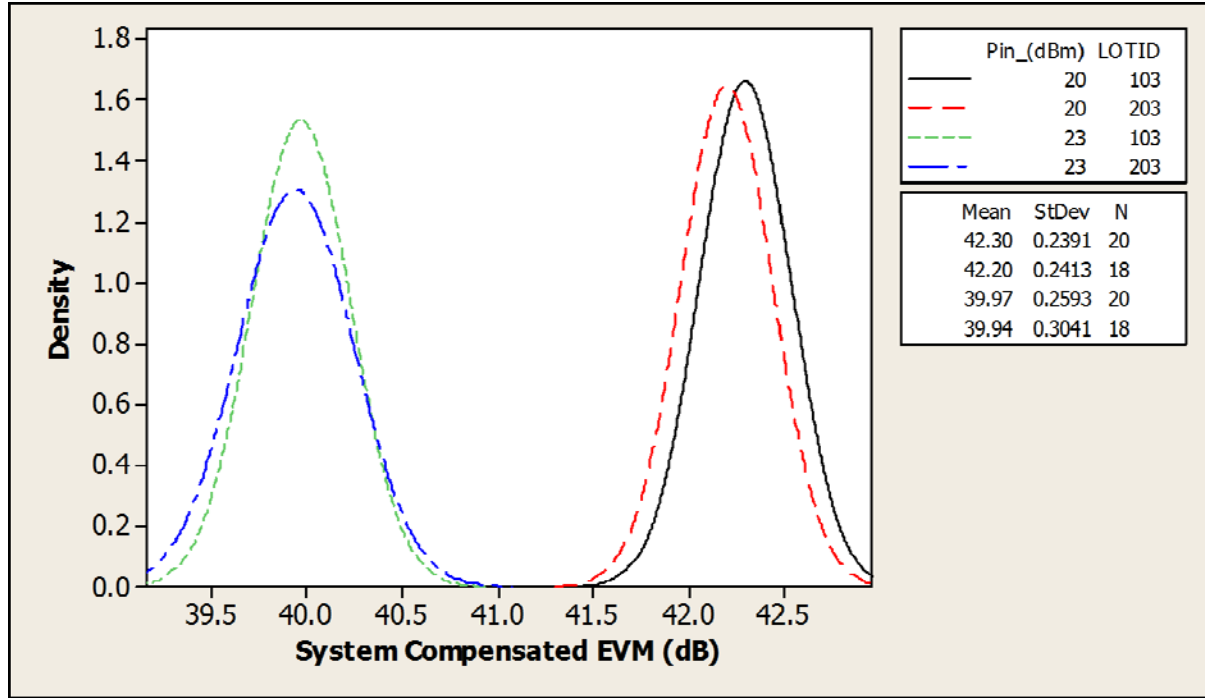

## Lead-Free 2 mm STQFN-12LD-0.4mm Pitch<sup>†</sup>

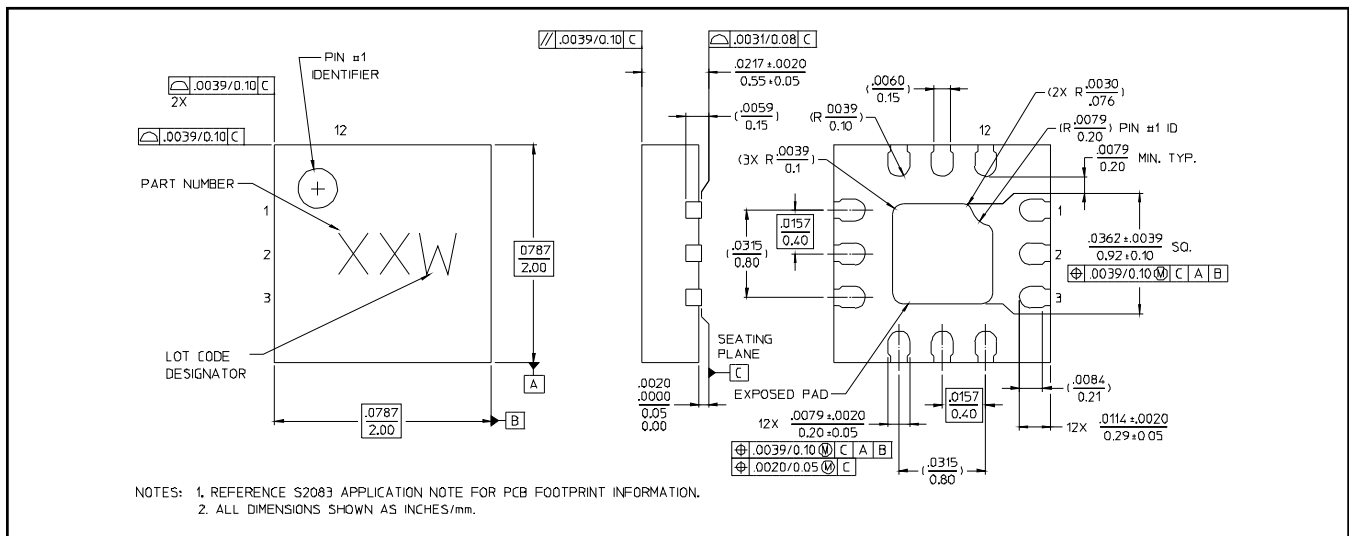

<sup>†</sup> Reference Application Note S2083 for lead-free solder reflow recommendations.  
Meets JEDEC moisture sensitivity level 1 requirements.  
Plating is Ni/Pd/Au over Copper.