

50V, 3A Power Module

Features

- Easy to Use
 - Stable with Low-Equivalent Series Resistance (ESR) Ceramic Output Capacitor
 - No Inductor and No Compensation to Choose
- 4.5V to 50V Input Voltage
- Single-Supply Operation
- Power Good (PG) Output
- Low Radiated Emission (EMI) per EN55022, Class B
- Adjustable Current Limit
- Adjustable Output Voltage from 0.9V to 24V (Also Limited by Duty Cycle)
- 200 kHz to 600 kHz, Programmable Switching Frequency
- Supports Safe Start-Up into a Prebiased Output
- -40°C to $+125^{\circ}\text{C}$ Junction Temperature Range
- Available in 64-pin, 12 mm \times 12 mm \times 3 mm QFN Package

Applications

- Distributed Power Systems
- Industrial
- Medical
- Telecom
- Automotive

General Description

MIC28303 is synchronous step-down regulator module, featuring a unique adaptive ON-time control architecture. The module incorporates a DC/DC controller, power MOSFETs, bootstrap diode, bootstrap capacitor and an inductor in a single package. The MIC28303 operates over an input supply range from 4.5V-50V and can be used to supply up to 3A of output current. The output voltage is adjustable down to 0.8V with an accuracy of $\pm 1\%$. The device operates with programmable switching frequency from 200 kHz-600 kHz.

The MIC28303-1 uses HyperLight Load[®] architecture for improved efficiency at light loads. The MIC28303-2 uses Hyper Speed Control[®] for ultra-fast transient response.

The MIC28303 offers a full suite of protection features. These include undervoltage lockout, internal soft-start, foldback current limit, hiccup mode short-circuit protection and thermal shutdown.

Typical Application Circuit

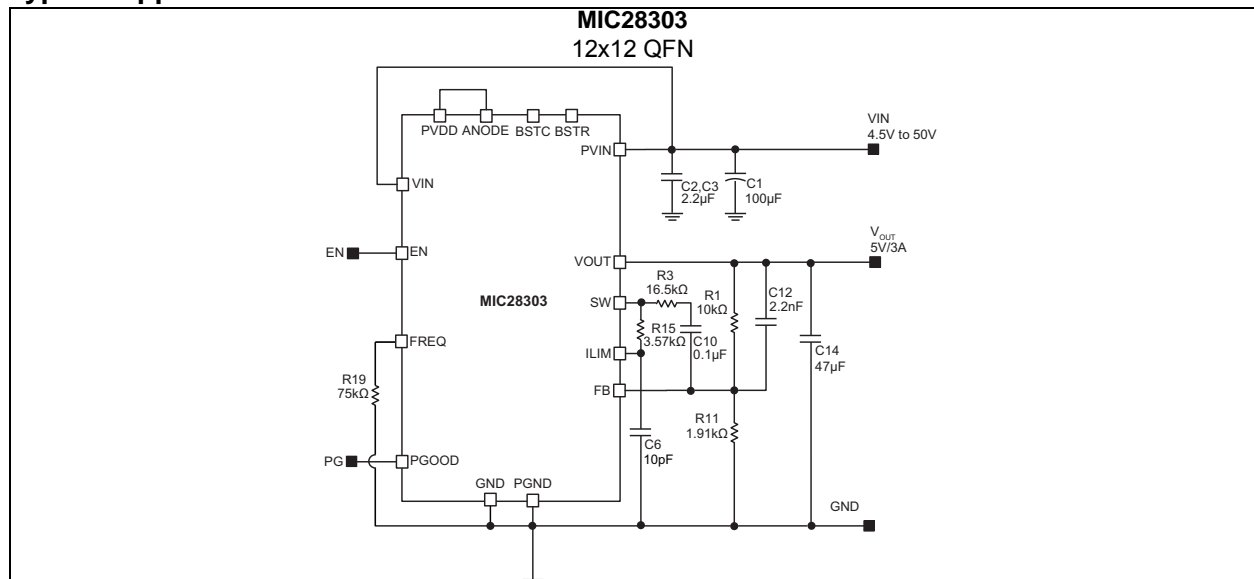

MIC28303

Functional Block Diagram

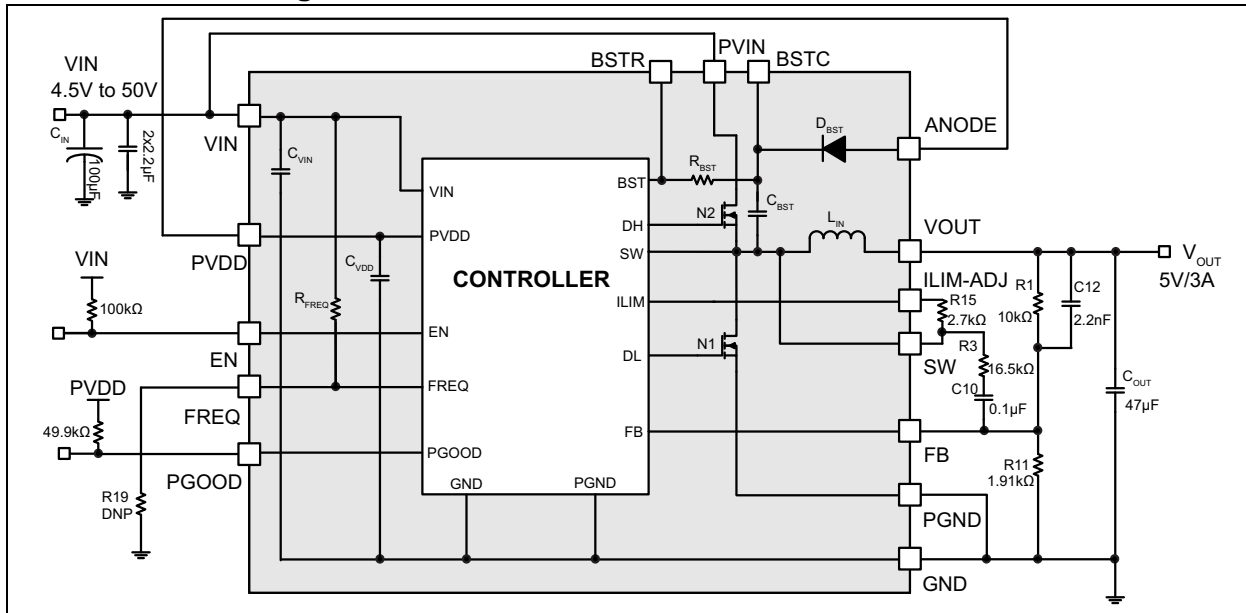

1.0 ELECTRICAL CHARACTERISTICS

Absolute Maximum Ratings †

P_{VIN}, V_{IN} to P_{GND}	-0.3V to +56V
P_{VDD}, V_{ANODE} to P_{GND}	-0.3V to +6V
$V_{SW}, V_{FREQ}, V_{ILIM}, V_{EN}$	-0.3V to ($P_{VIN} + 0.3V$)
$V_{BSTC/BSTR}$ to V_{SW}	-0.3V to 6V
$V_{BSTC/BSTR}$ to P_{GND}	-0.3V to 56V
V_{FB}, V_{PG} to P_{GND}	-0.3V to ($P_{VDD} + 0.3V$)
P_{GND} to A_{GND}	-0.3V to +0.3V
ESD Rating ⁽¹⁾	ESD Sensitive

Operating Ratings ‡

Supply Voltage (P_{VIN}, V_{IN})	4.5V to 50V
Enable Input (V_{EN})	0V to V_{IN}
$V_{SW}, V_{FREQ}, V_{ILIM}, V_{EN}$	0V to V_{IN}
Power Good (V_{PGOOD})	0V to P_{VDD}

† **Notice:** Stresses above those listed under “Absolute Maximum Ratings” may cause permanent damage to the device. This is a stress rating only and functional operation of the device at those or any other conditions above those indicated in the operational sections of this specification is not intended. Exposure to maximum rating conditions for extended periods may affect device reliability.

‡ **Notice:** The device is not guaranteed to function outside its operating ratings.

Note 1: Devices are ESD sensitive. Handling precautions are recommended. Human body model, 1.5 k Ω in series with 100 pF.

MIC28303

TABLE 1-1: ELECTRICAL CHARACTERISTICS

Electrical Characteristics: $PV_{IN} = V_{IN} = 12V$, $V_{OUT} = 5V$, $V_{BST} - V_{SW} = 5V$; $T_A = 25^\circ C$, unless noted. Bold values indicate $-40^\circ C \leq T_J \leq +125^\circ C$. (Note 1).					
Parameters	Min.	Typ.	Max.	Units	Conditions
Power Supply Input					
Input Voltage Range (PV_{IN} , V_{IN})	4.5	—	50	V	—
Controller Supply Current	—	0.4	0.75	mA	Current into Pin 60; $V_{FB} = 1.5V$ (MIC28303-1)
	—	2.1	3.0		Current into Pin 60; $V_{FB} = 1.5V$ (MIC28303-2)
	—	0.1	10	μA	Current into Pin 60; $V_{EN} = 0V$
Operating Current	—	0.7	—	mA	$I_{OUT} = 0A$ (MIC28303-1)
	—	27	—		$I_{OUT} = 0A$ (MIC28303-2)
Shutdown Supply Current	—	4.0	—	μA	$PV_{IN} = V_{IN} = 12V$, $V_{EN} = 0V$
P_{VDD} Supply					
P_{VDD} Output Voltage	4.8	5.2	5.4	V	$V_{IN} = 7V-50V$, $I_{PVDD} = 10mA$
P_{VDD} UVLO Threshold	3.8	4.2	4.7		P_{VDD} rising
P_{VDD} UVLO Hysteresis	—	400	—	mV	—
Load Regulation	0.6	2.0	3.6	%	$I_{PVDD} = 0$ to 40mA
Reference					
Feedback Reference Voltage	0.792	0.8	0.808	V	$T_J = 25^\circ C$ ($\pm 1.0\%$)
	0.784	0.8	0.816		$-40^\circ C \leq T_J \leq 125^\circ C$ ($\pm 2\%$)
FB Bias Current	—	5	500	nA	$V_{FB} = 0.8V$
Enable Control					
EN Logic Level High	1.8	—	—	V	—
EN Logic Level Low	—	—	0.6		—
EN Hysteresis	—	200	—	mV	—
EN Bias Current	—	5	20	μA	$V_{EN} = 12V$
Oscillator					
Switching Frequency	400	600	750	kHz	FREQ pin = open
	—	300	—		$R_{FREQ} = 100k\Omega$ (FREQ pin-to-GND)
Maximum Duty Cycle	—	85	—	%	—
Minimum Duty Cycle	—	0	—		$V_{FB} > 0.8V$
Minimum Off-Time	140	200	260	ns	—
Soft-Start					
Soft-Start Time	—	5	—	ms	—
Short-Circuit Protection					
Current Limit Protection (V_{CL})	-30	-14	0	mV	$V_{FB} = 0.79V$
Short-Circuit Threshold	-23	-7	9	mV	$V_{FB} = 0V$

Note 1: Specification for packaged product only.

TABLE 1-1: ELECTRICAL CHARACTERISTICS (CONTINUED)

Electrical Characteristics: $PV_{IN} = V_{IN} = 12V$, $V_{OUT} = 5V$, $V_{BST} - V_{SW} = 5V$; $T_A = 25^\circ C$, unless noted. Bold values indicate $-40^\circ C \leq T_J \leq +125^\circ C$. (Note 1).					
Parameters	Min.	Typ.	Max.	Units	Conditions
Current-Limit Source Current	60	80	100	μA	$V_{FB} = 0.79V$
Short-Circuit Source Current	27	36	47		$V_{FB} = 0V$
Leakage					
SW, BSTR Leakage Current	—	—	50	μA	—
Power Good					
Power Good Threshold Voltage	85	90	95	$\%V_{OUT}$	Sweep V_{FB} from low-to-high
Power Good Hysteresis	—	6	—		Sweep V_{FB} from high-to-low
Power Good Delay Time	—	100	—	μs	Sweep V_{FB} from low-to-high
Power Good Low Voltage	—	70	200	mV	$V_{FB} < 90\% \times V_{NOM}$, $I_{PG} = 1\text{ mA}$
Thermal Protection					
Overtemperature Shutdown	—	160	—	$^\circ C$	T_J rising
Overtemperature Shutdown Hysteresis	—	4	—		—
Output Characteristic					
Output Voltage Ripple	—	16	—	mV	$I_{OUT} = 3A$
Line Regulation	—	0.36	—	%	$PV_{IN} = V_{IN} = 7V$ to $50V$, $I_{OUT} = 3A$
Load Regulation	—	0.75	—	%	$I_{OUT} = 0A$ to $3A$ $PV_{IN} = V_{IN} = 12V$ (MIC28303-1)
	—	0.05	—		$I_{OUT} = 0A$ to $3A$ $PV_{IN} = V_{IN} = 12V$ (MIC28303-2)
Output Voltage Deviation from Load Step	—	400	—	mV	I_{OUT} from $0A$ to $3A$ at $5\text{ A}/\mu s$ (MIC28303-1)
	—	500	—		I_{OUT} from $3A$ to $0A$ at $5\text{ A}/\mu s$ (MIC28303-1)
	—	400	—		I_{OUT} from $0A$ to $3A$ at $5\text{ A}/\mu s$ (MIC28303-2)
	—	500	—		I_{OUT} from $3A$ to $0A$ at $5\text{ A}/\mu s$ (MIC28303-2)

Note 1: Specification for packaged product only.

MIC28303

TEMPERATURE SPECIFICATIONS

Parameters	Sym.	Min.	Typ.	Max.	Units	Conditions
Temperature Ranges						
Junction Operating Temperature	T_J	-40	—	+125	°C	Note 1
Storage Temperature Range	T_S	-65	—	+150	°C	—
Junction Temperature	T_J	—	—	+150	°C	—
Lead Temperature	—	—	—	+260	°C	Soldering, 10s
Package Thermal Resistances						
Thermal Resistance 12 mm x 12 mm QFN-64LD	θ_{JA}	—	20	—	°C/W	—
	θ_{JC}	—	5	—	°C/W	—

Note 1: The maximum allowable power dissipation is a function of ambient temperature, the maximum allowable junction temperature and the thermal resistance from junction to air (i.e., T_A , T_J , θ_{JA}). Exceeding the maximum allowable power dissipation will cause the device operating junction temperature to exceed the maximum +125°C rating. Sustained junction temperatures above +125°C can impact the device reliability.

2.0 TYPICAL PERFORMANCE CURVES

Note: The graphs and tables provided following this note are a statistical summary based on a limited number of samples and are provided for informational purposes only. The performance characteristics listed herein are not tested or guaranteed. In some graphs or tables, the data presented may be outside the specified operating range (e.g., outside specified power supply range) and therefore outside the warranted range.

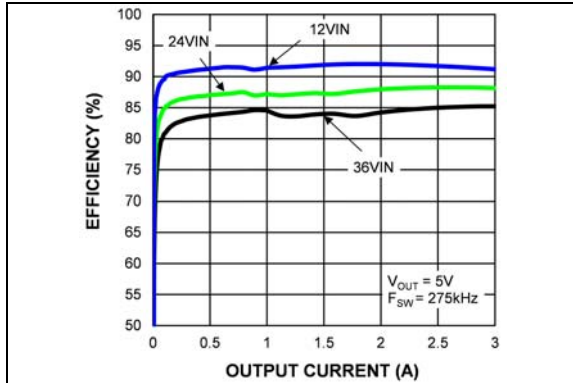

FIGURE 2-1: Efficiency vs. Output Current (MIC28303-1).

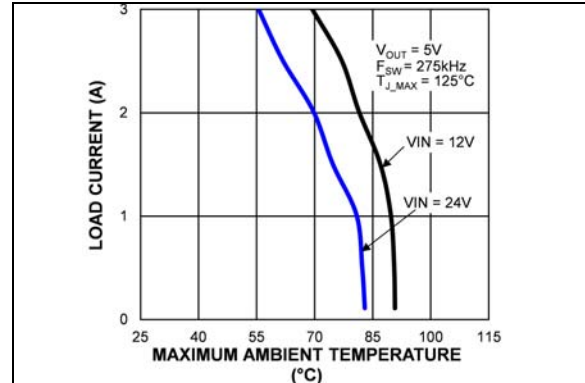

FIGURE 2-3: Thermal Derating (MIC28303-2).

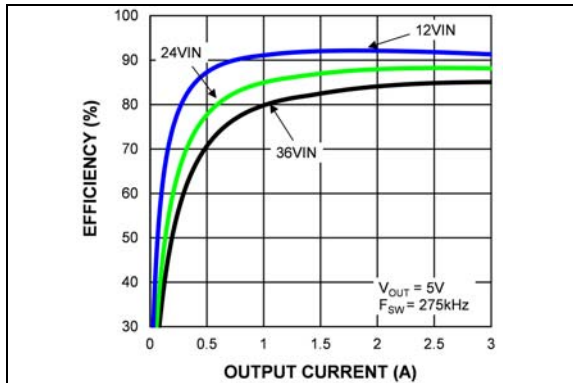

FIGURE 2-2: Efficiency vs. Output Current (MIC28303-2).

TABLE 2-1: RECOMMENDED COMPONENT VALUES FOR 275KHZ SWITCHING FREQUENCY

V _{OUT}	V _{IN}	R3 (R _{inj})	R19	R15	R1 (Top Feedback Resistor)	R11 (Bottom Feedback Resistor)	C10 (C _{inj})	C12 (C _{ff})	C _{OUT}
5V	7V-18V	16.5 kΩ	75 kΩ	3.57 kΩ	10 kΩ	1.9 kΩ	0.1 μF	2.2 nF	2 x 47 μF/6.3V
5V	18V-50V	39.2 kΩ	75 kΩ	3.57 kΩ	10 kΩ	1.9 kΩ	0.1 μF	2.2 nF	2 x 47 μF/6.3V
3.3V	5V-18V	16.5 kΩ	75 kΩ	3.57 kΩ	10 kΩ	3.24 kΩ	0.1 μF	2.2 nF	2 x 47 μF/6.3V
3.3V	18V-50V	39.2 kΩ	75 kΩ	3.57 kΩ	10 kΩ	3.24 kΩ	0.1 μF	2.2 nF	2 x 47 μF/6.3V

MIC28303

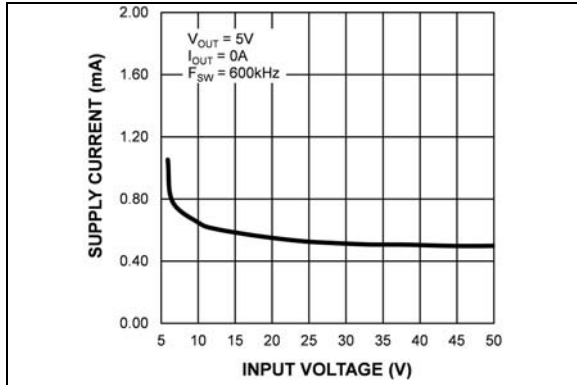

FIGURE 2-4: V_{IN} Operating Supply vs. Input Voltage (MIC28303-1).

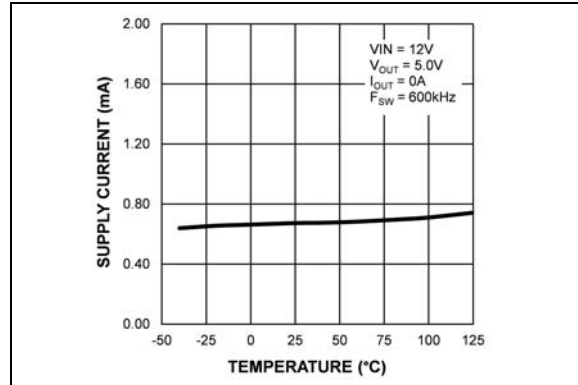

FIGURE 2-7: V_{IN} Operating Supply Current vs. Temperature (MIC28303-1).

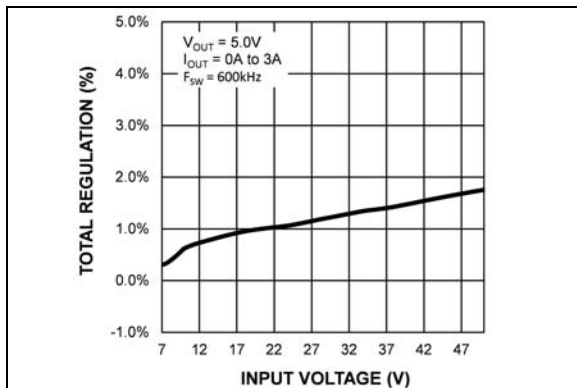

FIGURE 2-5: Output Regulation vs. Input Voltage (MIC28303-1).

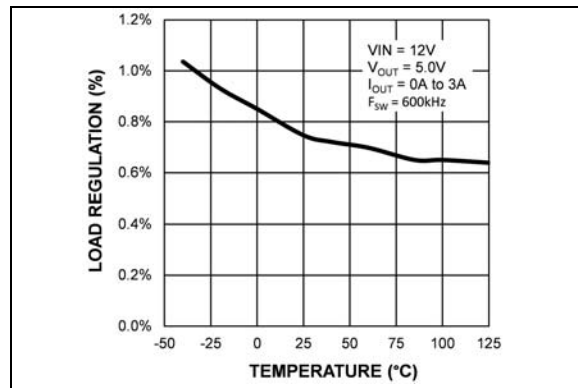

FIGURE 2-8: Load Regulation vs. Temperature (MIC28303-1).

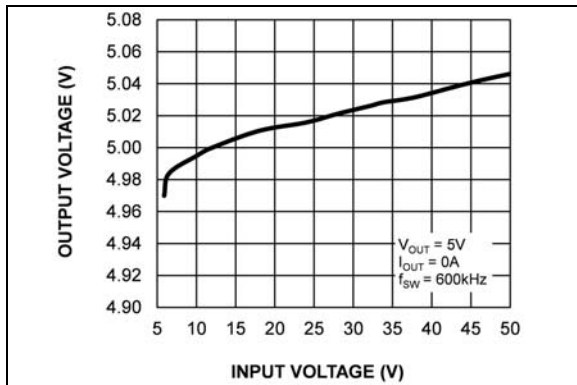

FIGURE 2-6: Output Voltage vs. Input Voltage (MIC28303-1).

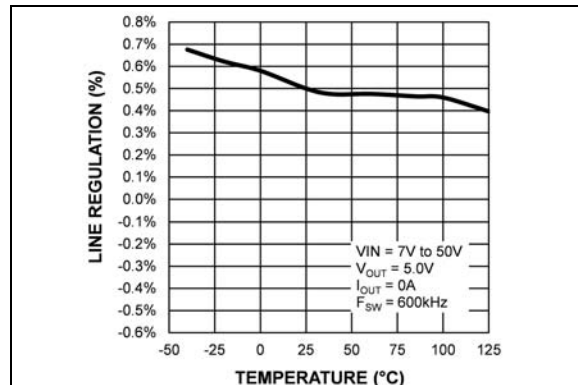

FIGURE 2-9: Line Regulation vs. Temperature (MIC28303-1).

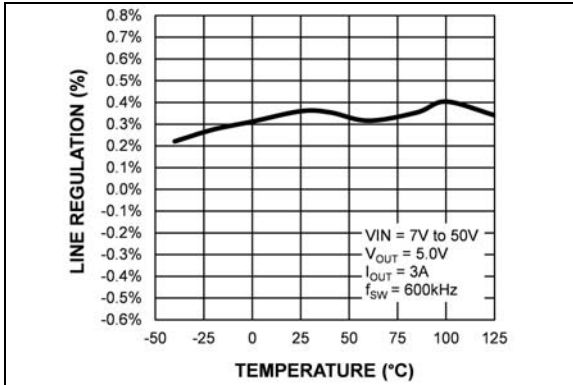

FIGURE 2-10: Line Regulation vs. Temperature (MIC28303-1).

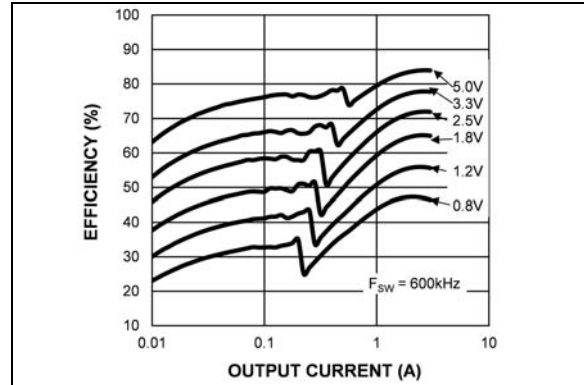

FIGURE 2-13: Efficiency ($V_{IN} = 24V$) vs. Output Current (MIC28303-1).

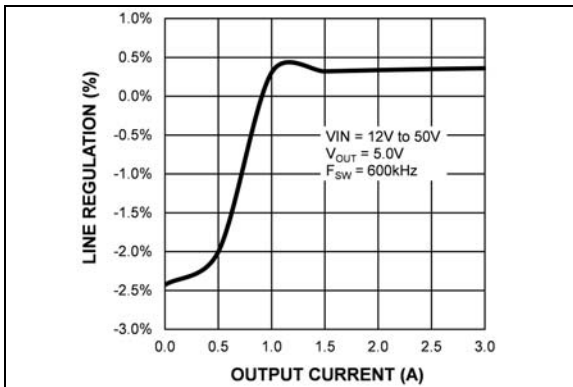

FIGURE 2-11: Line Regulation vs. Output Current (MIC28303-1).

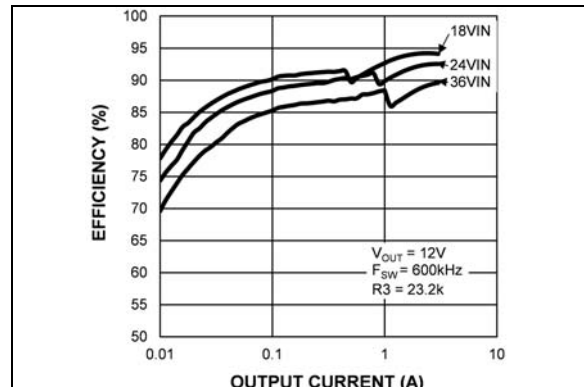

FIGURE 2-14: Efficiency vs. Output Current (MIC28303-1).

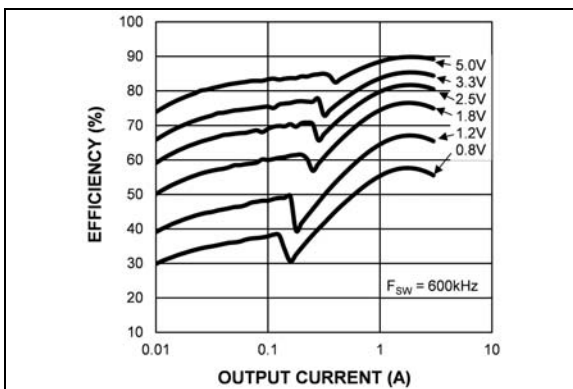

FIGURE 2-12: Efficiency ($V_{IN} = 12V$) vs. Output Current (MIC28303-1).

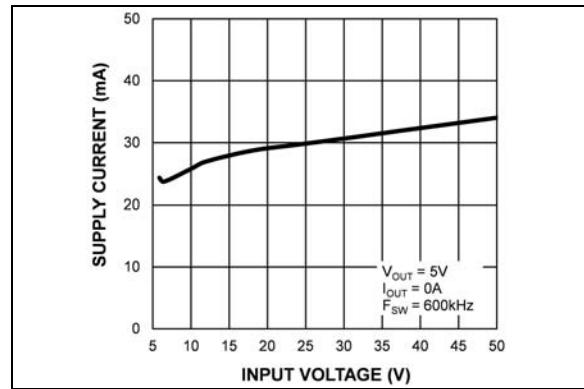

FIGURE 2-15: V_{IN} Operating Supply Current vs. Input Voltage (MIC28303-2).

MIC28303

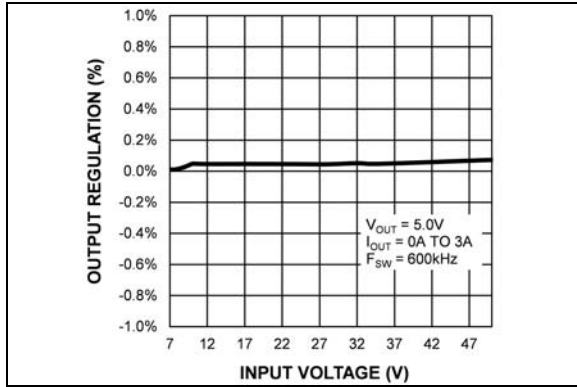

FIGURE 2-16: Output Regulation vs. Input Voltage (MIC28303-2).

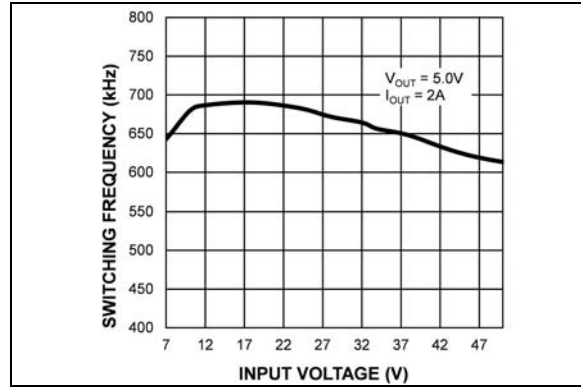

FIGURE 2-19: Switching Frequency vs. Input Voltage.

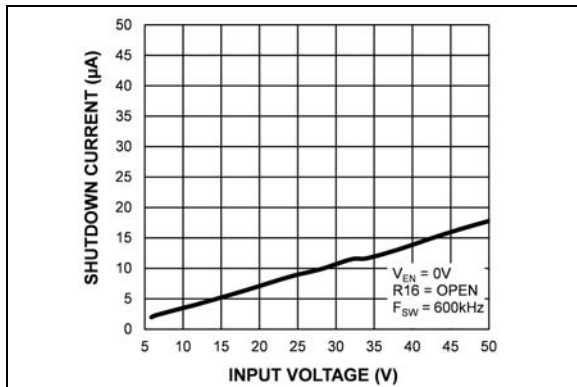

FIGURE 2-17: V_{IN} Shutdown Current vs. Input Voltage.

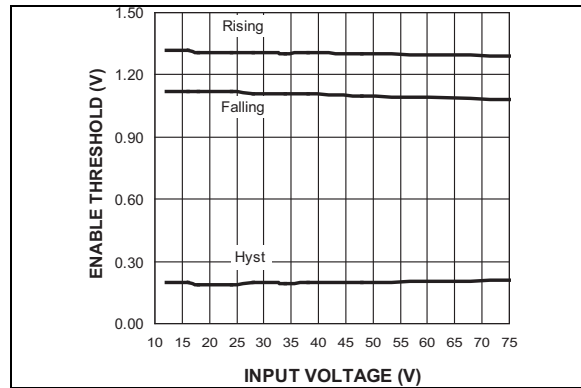

FIGURE 2-20: Enable Threshold vs. Input Voltage.

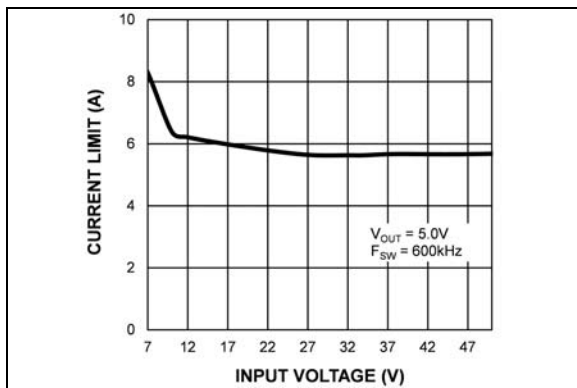

FIGURE 2-18: Output Peak Current Limit vs. Input Voltage.

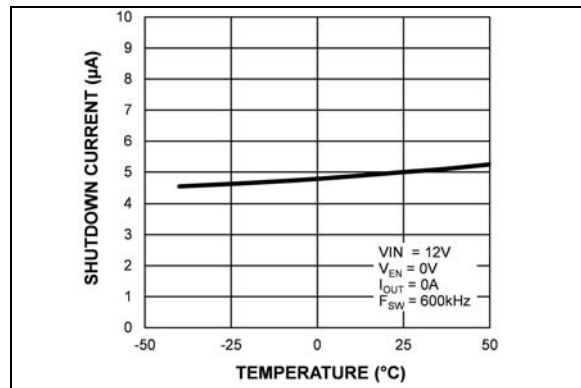

FIGURE 2-21: V_{IN} Shutdown Current vs. Temperature.

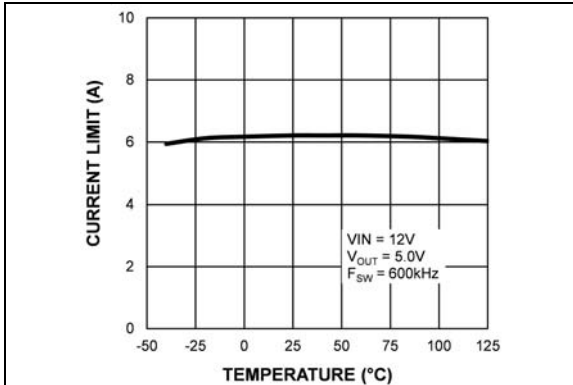

FIGURE 2-22: Output Peak Current Limit vs. Temperature.

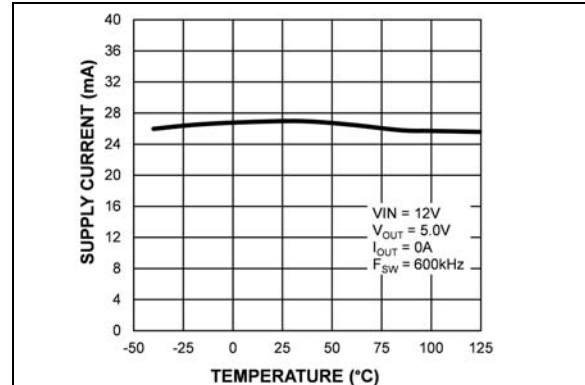

FIGURE 2-25: V_{IN} Operating Supply Current vs. Temperature (MIC28303-2).

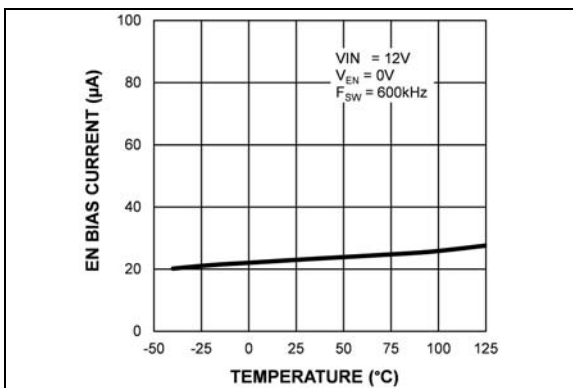

FIGURE 2-23: EN Bias Current vs. Temperature.

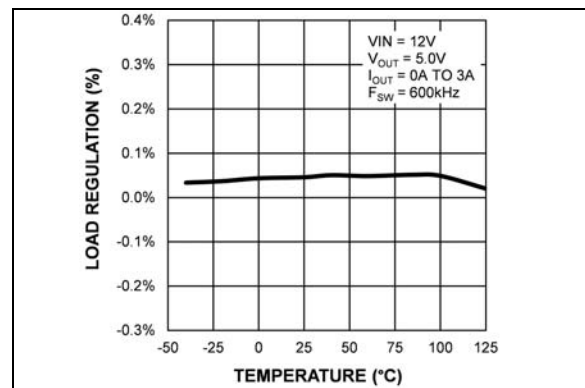

FIGURE 2-26: Load Regulation vs. Temperature (MIC28303-2).

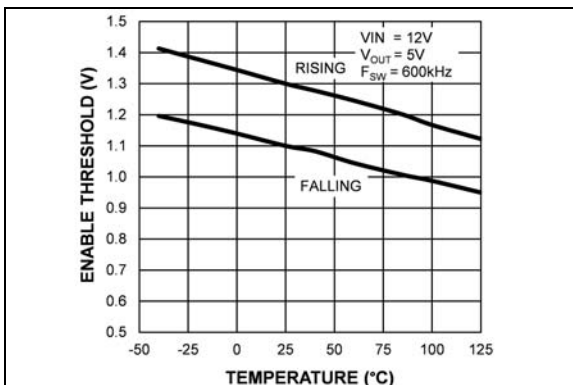

FIGURE 2-24: Enable Threshold vs. Temperature.

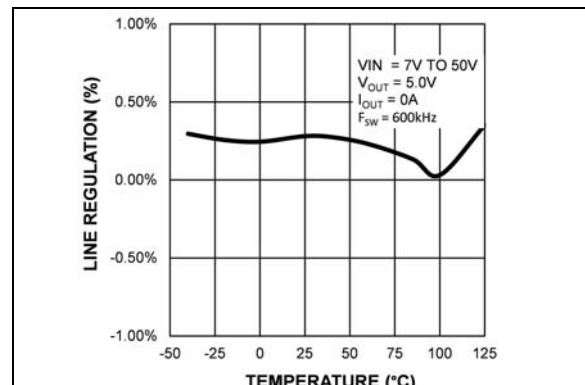

FIGURE 2-27: Line Regulation vs. Temperature (MIC28303-2).

MIC28303

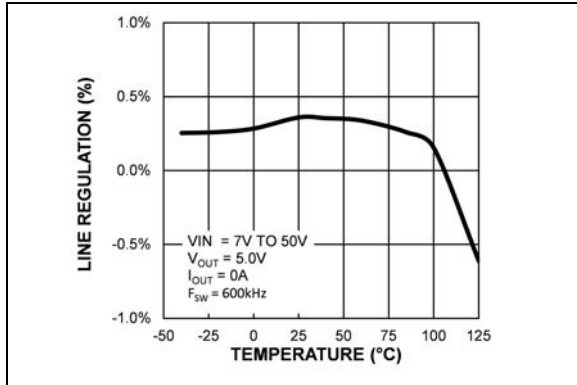

FIGURE 2-28: Line Regulation vs. Temperature (MIC28303-2).

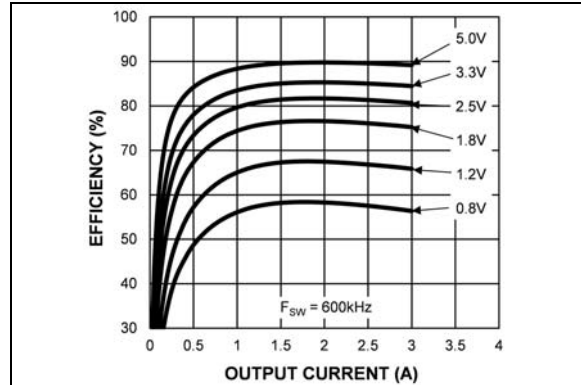

FIGURE 2-31: Efficiency ($V_{IN} = 12V$) vs. Output Current (MIC28303-2).

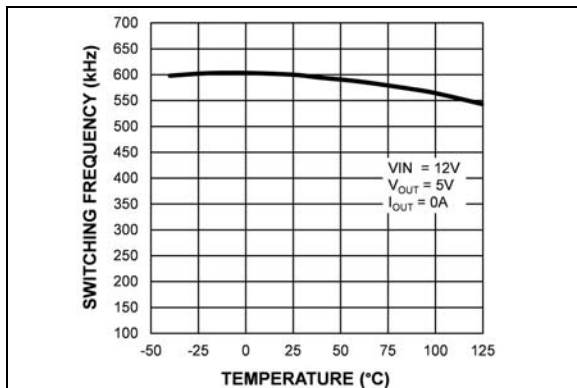

FIGURE 2-29: Switching Frequency vs. Temperature (MIC28303-2).

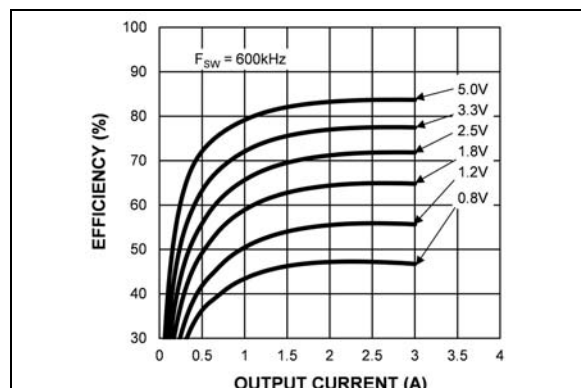

FIGURE 2-32: Efficiency ($V_{IN} = 24V$) vs. Output Current (MIC28303-2).

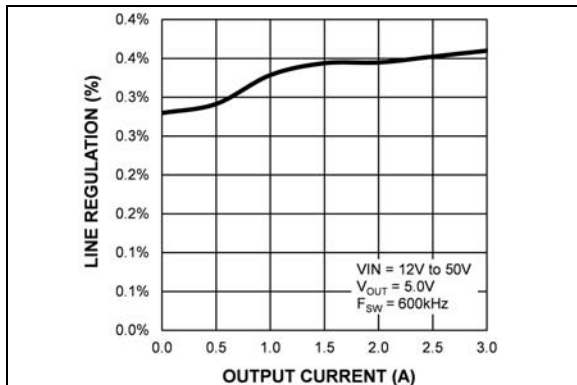

FIGURE 2-30: Line Regulation vs. Output Current (MIC28303-2).

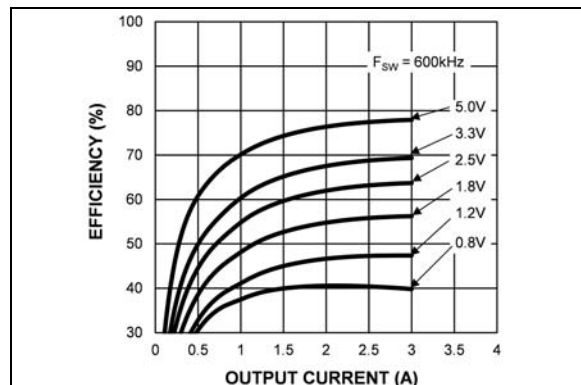

FIGURE 2-33: Efficiency ($V_{IN} = 38V$) vs. Output Current (MIC28303-2).

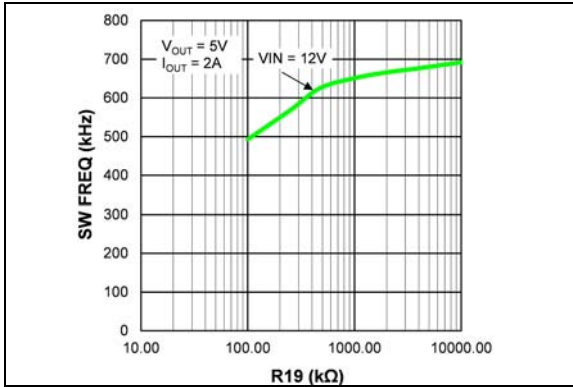

FIGURE 2-34: Switching Frequency.

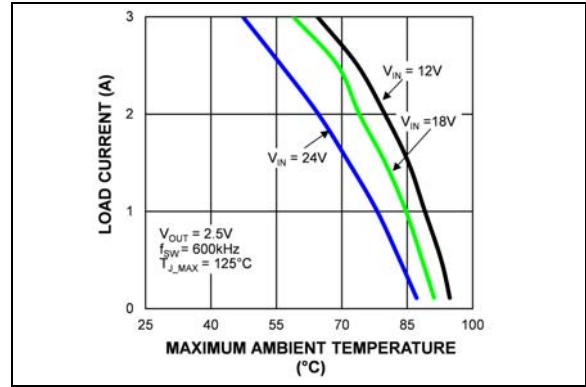

FIGURE 2-37: Thermal Derating (MIC28303-2).

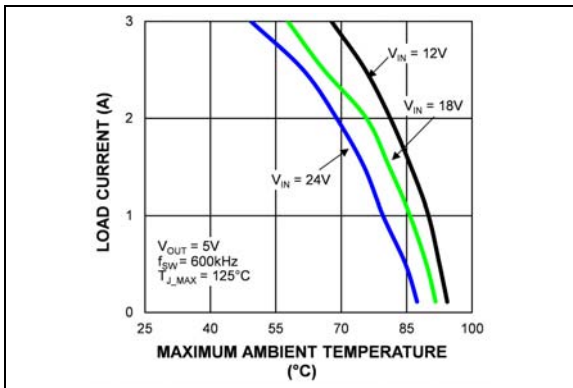

FIGURE 2-35: Thermal Derating (MIC28303-2).

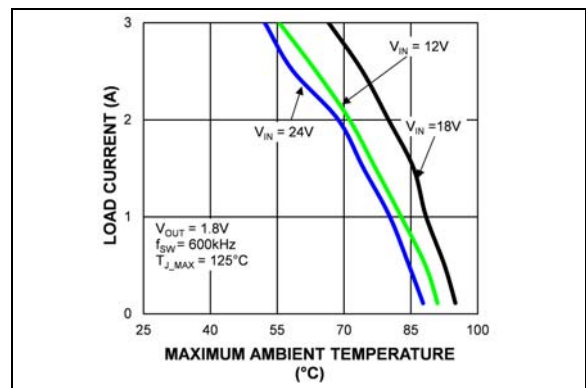

FIGURE 2-38: Thermal Derating (MIC28303-2).

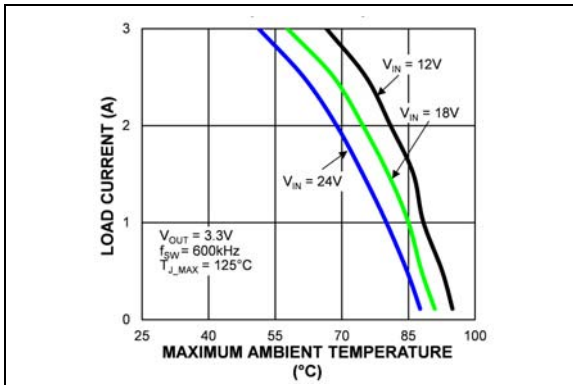

FIGURE 2-36: Thermal Derating (MIC28303-2).

MIC28303

TABLE 2-2: RECOMMENDED COMPONENT VALUES FOR 600 KHZ SWITCHING FREQUENCY

V_{OUT}	V_{IN}	R3 (R_{inj})	R1 (Top Feedback Resistor)	R11 (Bottom Feedback Resistor)	R19	C10 (C_{inj})	C12 (C_{ff})	C_{OUT}
0.9V	5V-50V	16.5 k Ω	10 k Ω	80.6 k Ω	DNP	0.1 μ F	2.2 nF	47 μ F/6.3V or 2 x 22 μ F
1.2V	5V-50V	16.5 k Ω	10 k Ω	20 k Ω	DNP	0.1 μ F	2.2 nF	47 μ F/6.3V or 2 x 22 μ F
1.8V	5V-50V	16.5 k Ω	10 k Ω	8.06 k Ω	DNP	0.1 μ F	2.2 nF	47 μ F/6.3V or 2 x 22 μ F
2.5V	5V-50V	16.5 k Ω	10 k Ω	4.75 k Ω	DNP	0.1 μ F	2.2 nF	47 μ F/6.3V or 2 x 22 μ F
3.3V	5V-50V	16.5 k Ω	10 k Ω	3.24 k Ω	DNP	0.1 μ F	2.2 nF	47 μ F/6.3V or 2 x 22 μ F
5V	7V-50V	16.5 k Ω	10 k Ω	1.9 k Ω	DNP	0.1 μ F	2.2 nF	47 μ F/6.3V or 2 x 22 μ F
12V	18V-50V	23.2 k Ω	10 k Ω	715 k Ω	DNP	0.1 μ F	2.2 nF	47 μ F/16V or 2 x 22 μ F

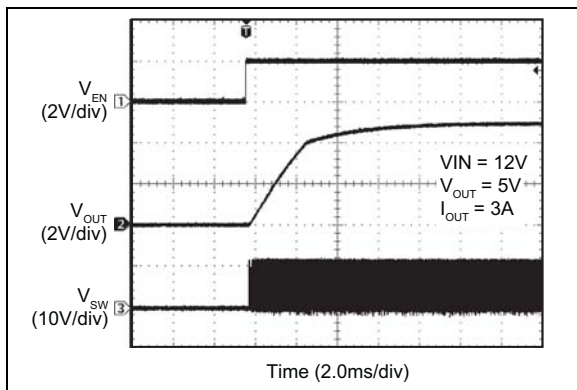

FIGURE 2-39: Enable Turn-On Delay and Rise Time.

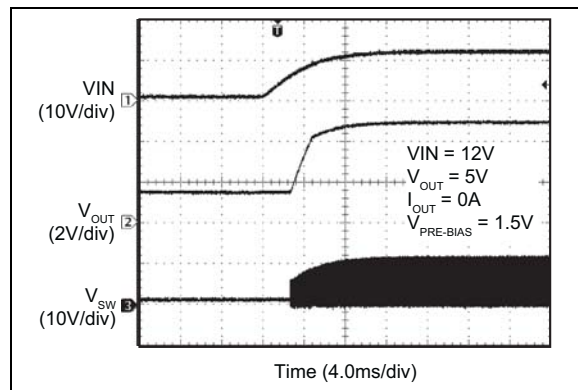

FIGURE 2-41: MIC28303-2 V_{IN} Start-Up with Pre-Biased Output.

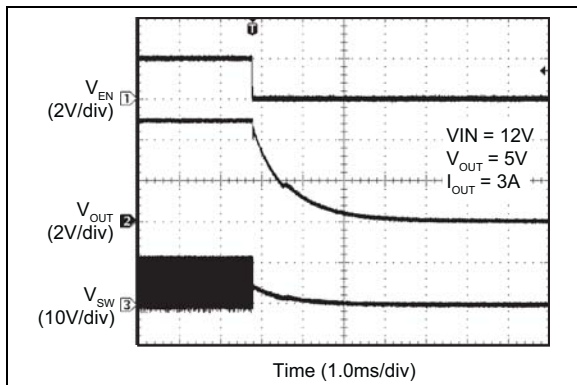

FIGURE 2-40: Enable Turn-Off Delay and Fall Time.

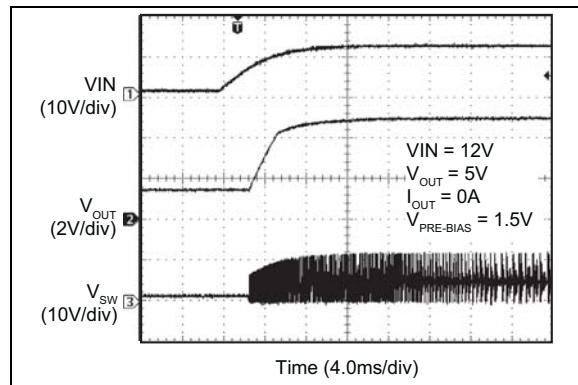

FIGURE 2-42: MIC28303-1 V_{IN} Start-Up with Pre-Biased Output.

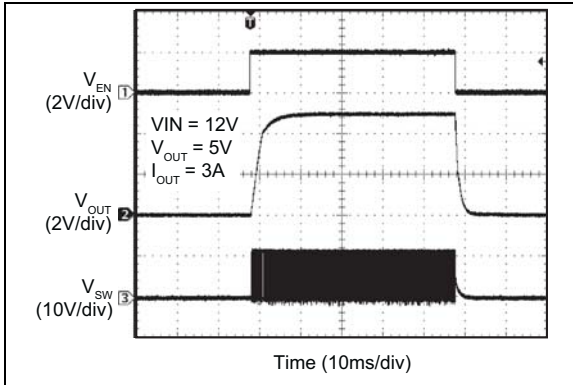

FIGURE 2-43: Enable Turn-On/Turn-Off.

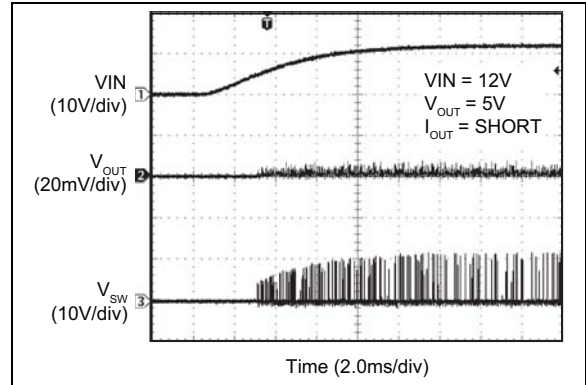

FIGURE 2-46: Power-Up into Short-Circuit.

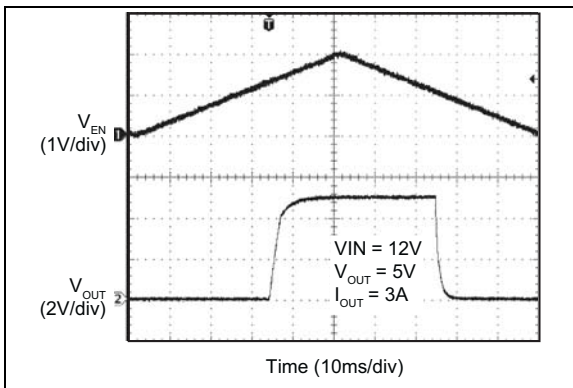

FIGURE 2-44: Enable Thresholds.

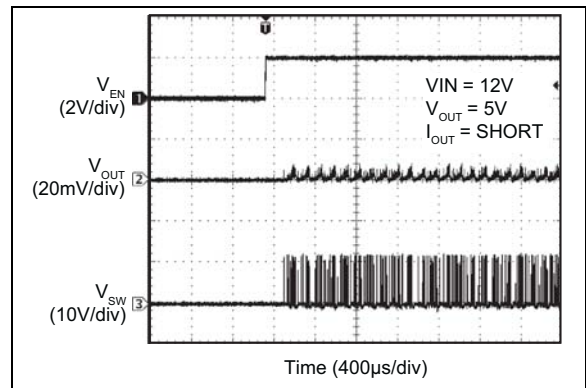

FIGURE 2-47: Enabled into Short.

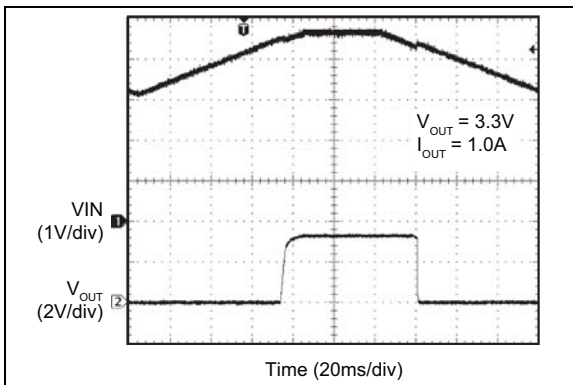

FIGURE 2-45: UVLO Thresholds.

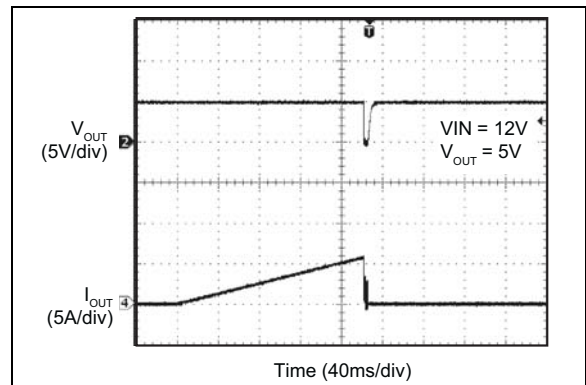

FIGURE 2-48: Output Peak Current-Limit Threshold.

MIC28303

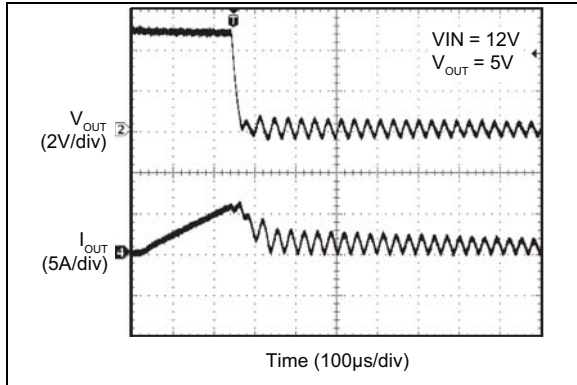

FIGURE 2-49: Short Circuit.

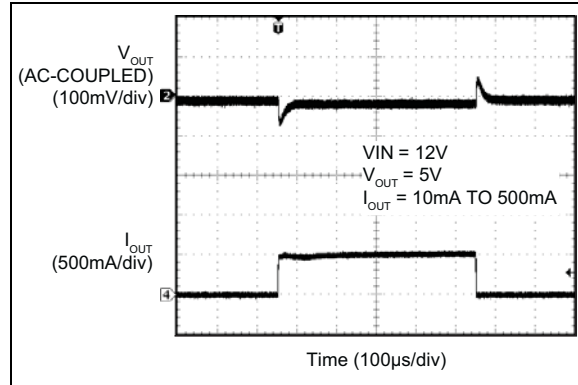

FIGURE 2-52: MIC28303-2 Transient Response.

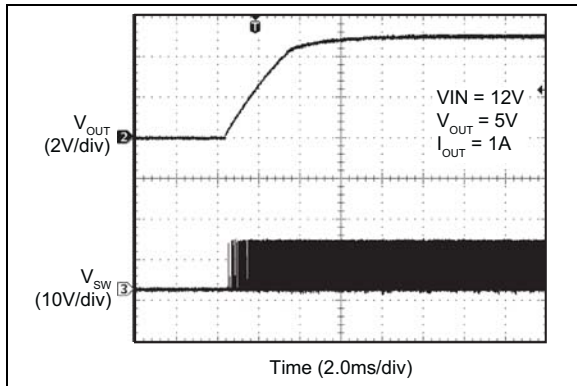

FIGURE 2-50: Output Recovery from Thermal Shutdown.

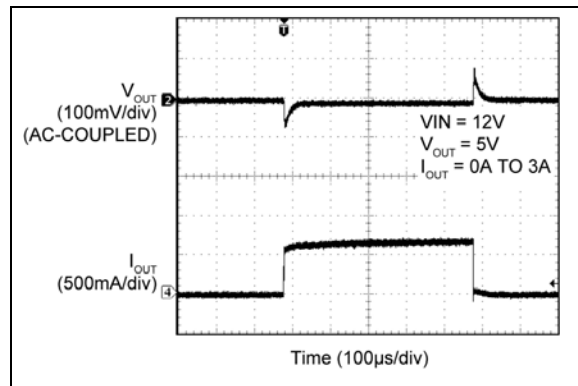

FIGURE 2-53: MIC28303-2 Transient Response.

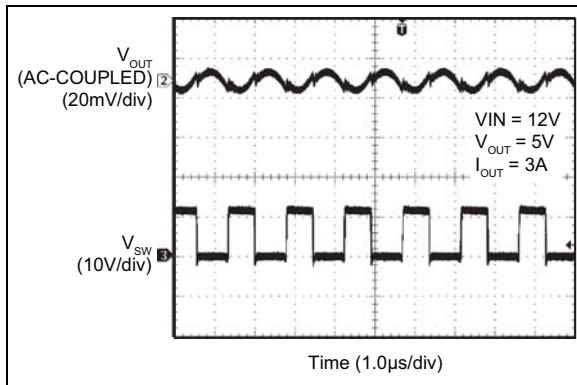

FIGURE 2-51: MIC28303-2 Switching Waveforms (I_{OUT} = 3A).

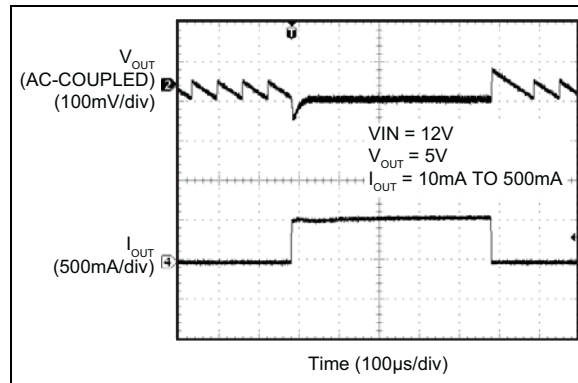

FIGURE 2-54: MIC28303-1 Transient Response.

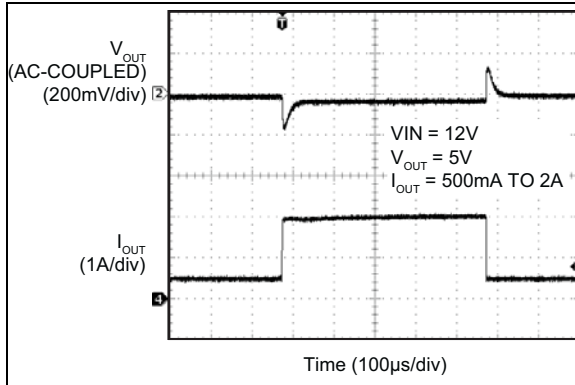

FIGURE 2-55: MIC28303-2 Transient Response.

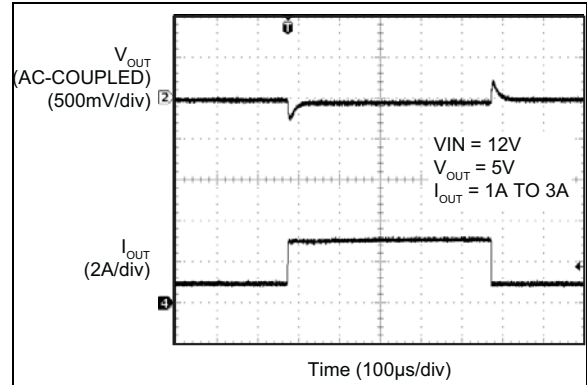

FIGURE 2-58: MIC28303-1 Transient Response.

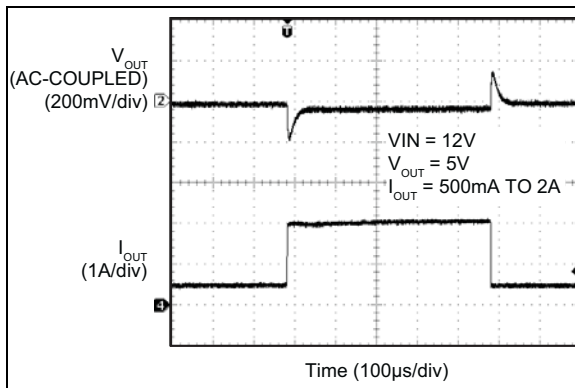

FIGURE 2-56: MIC28303-1 Transient Response.

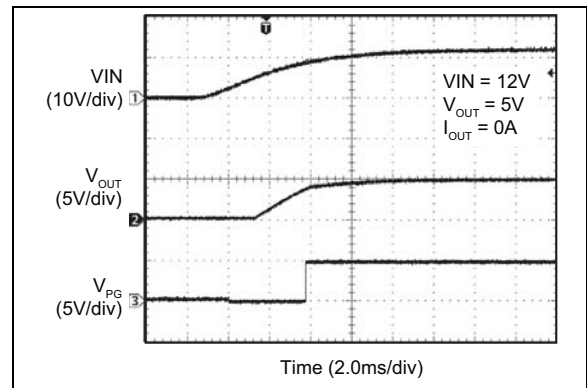

FIGURE 2-59: Power Good at V_{IN} Soft Turn-On.

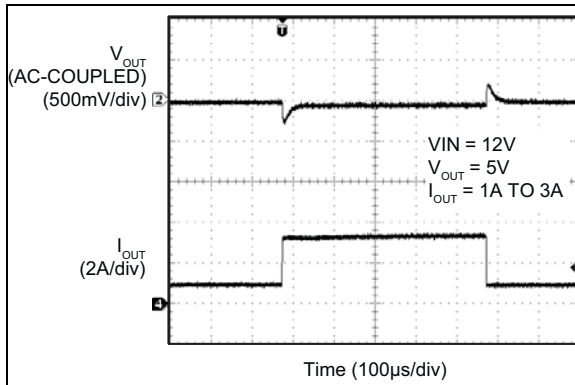

FIGURE 2-57: MIC28303-2 Transient Response.

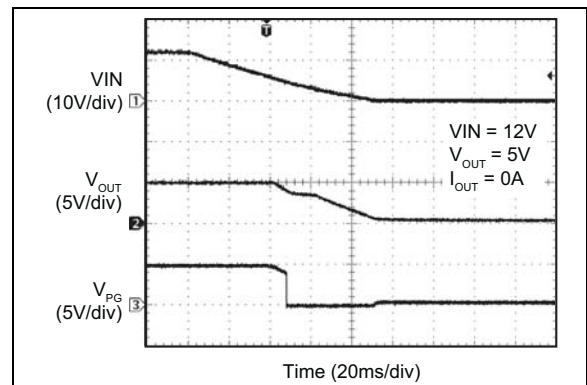

FIGURE 2-60: Power Good at V_{IN} Soft Turn-Off.

MIC28303

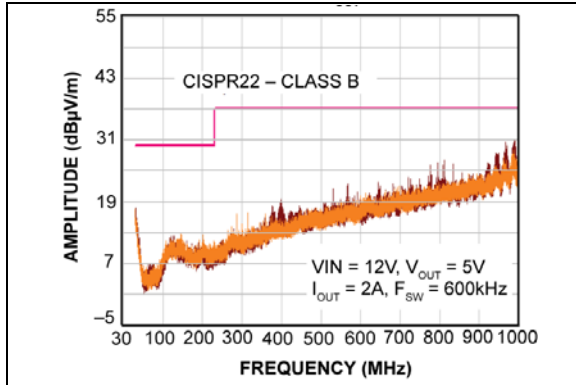

FIGURE 2-61: Radiated Emissions – 30 MHz to 1000 MHz ($V_{IN} = 12V/I_{OUT} = 2A$).

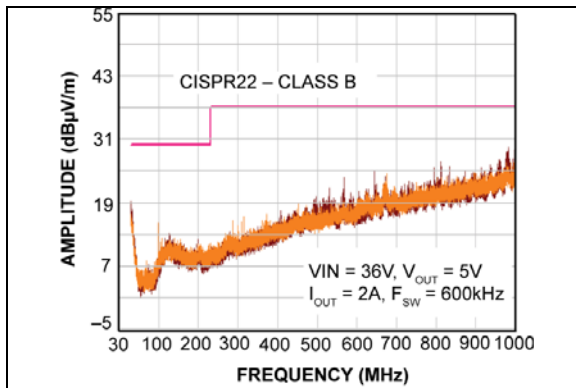

FIGURE 2-62: Radiated Emissions – 30 MHz to 1000 MHz ($V_{IN} = 36V/I_{OUT} = 2A$).

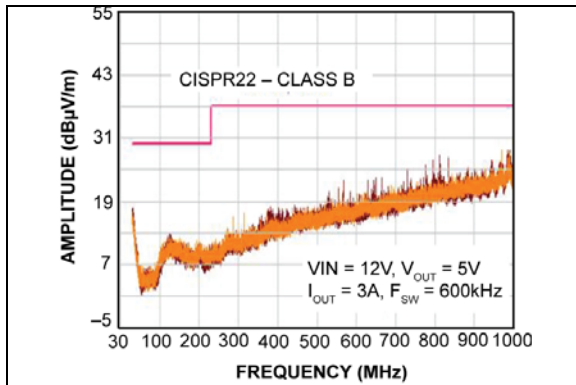
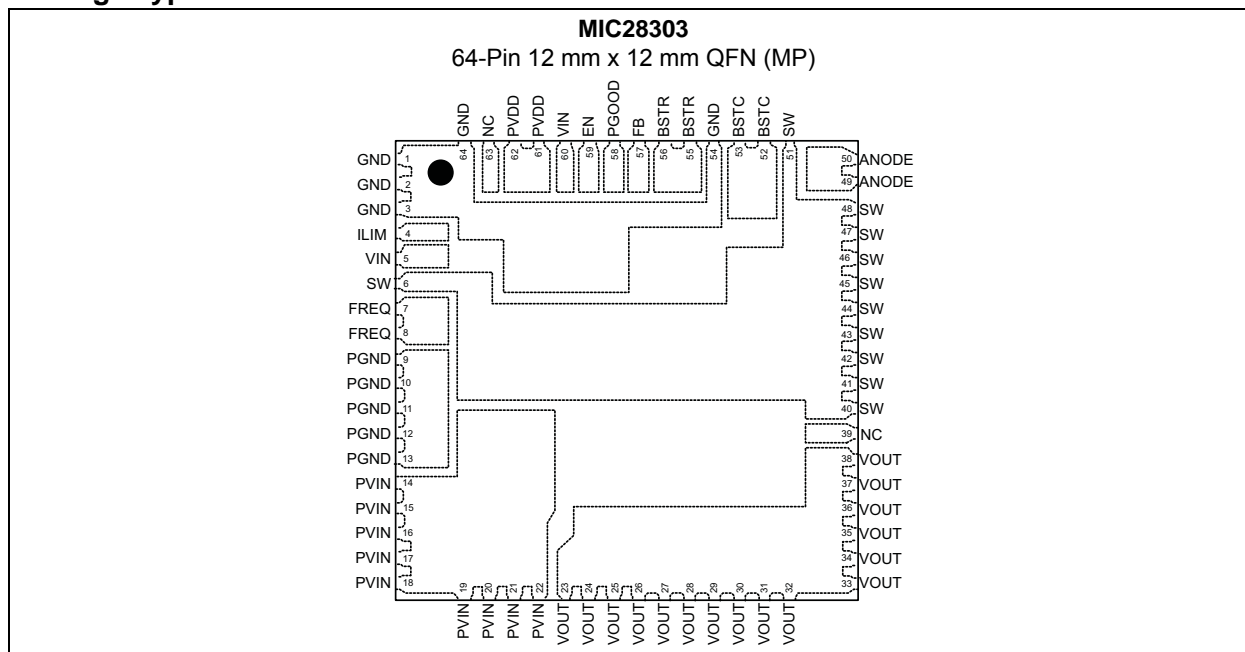

FIGURE 2-63: Radiated Emissions – 30 MHz to 1000 MHz ($V_{IN} = 12V/I_{OUT} = 3A$).

3.0 PIN DESCRIPTIONS

Package Type



The descriptions of the pins are listed in [Table 3-1](#).

TABLE 3-1: PIN FUNCTION TABLE

Pin Number	Symbol	Description
1, 2, 3, 54, 64	GND	Analog Ground. Ground for internal controller and feedback resistor network. The analog ground return path should be separate from the power ground (P _{GND}) return path.
4	I _{LIM}	Current Limit Setting. Connect a resistor from SW (Pin 6) to I _{LIM} to set the overcurrent threshold for the converter.
5, 60	V _{IN}	Supply Voltage for Controller. The V _{IN} operating voltage range is from 4.5V-50V. A 0.47 μF ceramic capacitor from V _{IN} (pin 60) to GND is required for decoupling. Pin 5 should be externally connected to either P _{V_{IN}} or Pin 60 on PCB.
6, 40 to 48, 51	SW	Switch Node and Current-Sense Input. High current output driver return. The SW pin connects directly to the switch node. Due to the high-speed switching on this pin, the SW pin should be routed away from sensitive nodes. The SW pin also senses the current by monitoring the voltage across the low-side MOSFET during OFF time.
7, 8	FREQ	Switching Frequency Adjust Input. Leaving this pin open will set the switching frequency to 600 kHz. Alternatively, a resistor from this pin to ground can be used to lower the switching frequency.
9 to 13	P _{GND}	Power Ground. P _{GND} is the return path for the buck converter power stage. The P _{GND} pin connects to the sources of low-side N-Channel external MOSFET, the negative terminals of input capacitors and the negative terminals of output capacitors. The return path for the power ground should be as small as possible and separate from the analog ground (GND) return path.
14 to 22	P _{V_{IN}}	Power Input Voltage. Connection to the drain of the internal high-side power MOSFET.
23 to 38	V _{OUT}	Output Voltage. Connection with the internal inductor, the output capacitor should be connected from this pin to P _{GND} as close to the module as possible.
39	NC	No Connection. Leave it floating.

MIC28303

TABLE 3-1: PIN FUNCTION TABLE (CONTINUED)

Pin Number	Symbol	Description
49, 50	ANODE	Anode Bootstrap Diode Input. Anode connection of internal bootstrap diode. This pin should be connected to the P _{VDD} pin.
52, 53	BSTC	Bootstrap Capacitor. Connection to the internal bootstrap capacitor. Leave floating, no connection.
55, 56	BSTR	Bootstrap Resistor. Connection to the internal bootstrap resistor and high-side power MOSFET drive circuitry. Leave floating, no connect.
57	FB	Feedback Input. Input to the transconductance amplifier of the control loop. The FB pin is regulated to 0.8V. A resistor divider connecting the feedback to the output is used to set the desired output voltage.
58	P _{GOOD}	Power Good Output. Open-drain output. An external pull-up resistor to external power rails is required.
59	EN	Enable Input. A logic signal to enable or disable the buck converter operation. The EN pin is CMOS compatible. Logic high enables the device, logic low shuts down the regulator. In the disable mode, the input supply current for the device is minimized to 4 μ A typically. Do not pull EN to P _{VDD} .
61, 62	P _{VDD}	Internal +5V Linear Regulator Output. P _{VDD} is the internal supply bus for the device. In the applications with V _{IN} < +5.5V, P _{VDD} should be tied to V _{IN} to bypass the linear regulator.
63	NC	No Connection. Leave it floating.

4.0 FUNCTIONAL DESCRIPTION

The MIC28303 is an adaptive on-time synchronous buck regulator module built for high-input voltage to low-output voltage conversion applications. The MIC28303 is designed to operate over a wide input voltage range, from 4.5V-50V, and the output is adjustable with an external resistor divider. An adaptive ON-time control scheme is employed to obtain a constant switching frequency and to simplify the control compensation. Hiccup mode overcurrent protection is implemented by sensing low-side MOSFET's $R_{DS(ON)}$. The device features internal soft-start, enable, UVLO and thermal shutdown. The module has integrated switching FETs, as well as an inductor, bootstrap diode, resistor and capacitor.

4.1 Theory of Operation

Per the Functional Diagram of the MIC28303 module, the output voltage is sensed by the MIC28303 feedback pin FB via the voltage divider R1 and R11, and compared to a 0.8V reference voltage V_{REF} at the error comparator through a low-gain transconductance (g_m) amplifier. If the feedback voltage decreases and the amplifier output is below 0.8V, then the error comparator will trigger the control logic and generate an ON-time period. The ON-time period length is predetermined by the Fixed t_{ON} Estimator circuitry:

EQUATION 4-1:

$$t_{ON(ESTIMATED)} = \frac{V_{OUT}}{V_{IN} \times f_{SW}}$$

Where:

V_{OUT}	Output Voltage
V_{IN}	Power Stage Input Voltage
f_{SW}	Switching Frequency

At the end of the ON-time period, the internal high-side driver turns off the high-side MOSFET and the low-side driver turns on the low-side MOSFET. The OFF-time period length depends on the feedback voltage in most cases. When the feedback voltage decreases and the output of the g_m amplifier is below 0.8V, the ON-time period is triggered and the OFF-time period ends. If the OFF-time period determined by the feedback voltage is less than the minimum OFF-time $t_{OFF(MIN)}$, which is about 200 ns, the MIC28303 control logic will apply the $t_{OFF(MIN)}$ instead. $t_{OFF(MIN)}$ is required to maintain enough energy in the boost capacitor (C_{BST}) to drive the high-side MOSFET.

The maximum duty cycle is obtained from the 200 ns $t_{OFF(MIN)}$:

EQUATION 4-2:

$$D_{MAX} = \frac{t_S - t_{OFF(MIN)}}{t_S} = 1 - \frac{200ns}{t_S}$$

Where:

t_S	$1/f_{SW}$
-------	------------

It is not recommended to use MIC28303 with an OFF-time close to $t_{OFF(MIN)}$ during steady-state operation.

The adaptive ON-time control scheme results in a constant switching frequency in the MIC28303. The actual ON-time and resulting switching frequency will vary with the different rising and falling times of the external MOSFETs. Also, the minimum t_{ON} results in a lower switching frequency in high V_{IN} to V_{OUT} applications. During load transients, the switching frequency is changed due to the varying OFF-time.

To illustrate the control loop operation, both the steady-state and load transient scenarios were analyzed. For easy analysis, the gain of the g_m amplifier is assumed to be 1. With this assumption, the inverting input of the error comparator is the same as the feedback voltage.

Figure 4-1 shows the MIC28303 control loop timing during steady-state operation. During steady state, the g_m amplifier senses the feedback voltage ripple, which is proportional to the output voltage ripple plus injected voltage ripple, to trigger the ON-time period. The ON-time is predetermined by the t_{ON} estimator. The termination of the OFF-time is controlled by the feedback voltage. At the valley of the feedback voltage ripple, which occurs when V_{FB} falls below V_{REF} , the OFF period ends and the next ON-time period is triggered through the control logic circuitry.

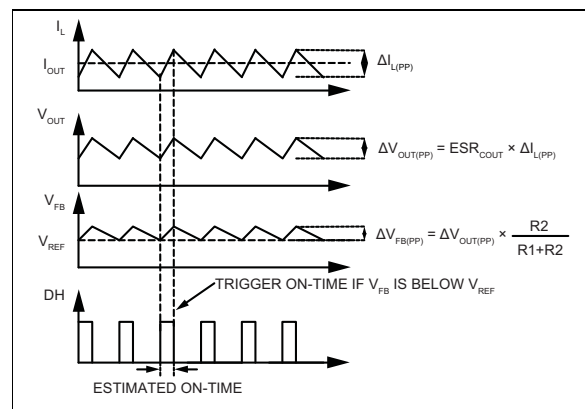

FIGURE 4-1: MIC28303 Control Loop Timing

Figure 4-2 shows the operation of the MIC28303 during a load transient. The output voltage drops due to the sudden load increase, which causes the V_{FB} to be less than V_{REF} . This will cause the error comparator to trigger an ON-time period. At the end of the ON-time period, a minimum OFF-time $t_{OFF(MIN)}$ is generated to

MIC28303

charge the bootstrap capacitor (C_{BST}) because the feedback voltage is still below V_{REF} . Then, the next ON-time period is triggered due to the low feedback voltage. Therefore, the switching frequency changes during the load transient, but returns to the nominal fixed frequency once the output has stabilized at the new load current level. With the varying duty cycle and switching frequency, the output recovery time is fast and the output voltage deviation is small.

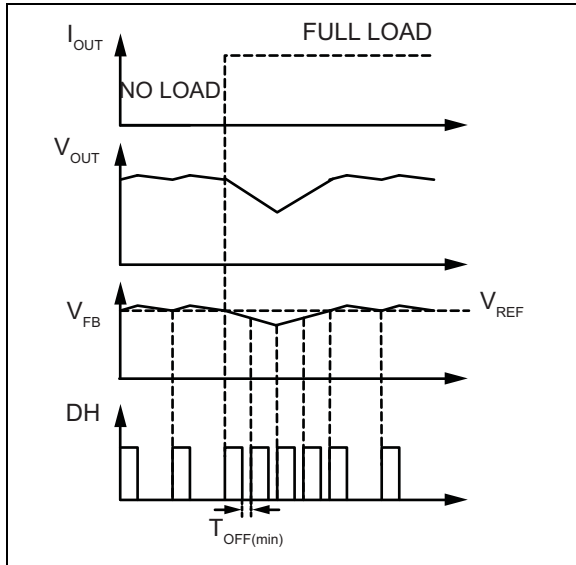

FIGURE 4-2: MIC28303 Load Transient Response

Unlike true current-mode control, the MIC28303 uses the output voltage ripple to trigger an ON-time period. The output voltage ripple is proportional to the inductor current ripple if the ESR of the output capacitor is large enough.

In order to meet the stability requirements, the MIC28303 feedback voltage ripple should be in phase with the inductor current ripple and be large enough to be sensed by the g_m amplifier and the error comparator. The recommended feedback voltage ripple is 20 mV ~ 100 mV over the full input voltage range. If a low ESR output capacitor is selected, then the feedback voltage ripple may be too small to be sensed by the g_m amplifier and the error comparator. Also, the output voltage ripple and the feedback voltage ripple are not necessarily in phase with the inductor current ripple if the ESR of the output capacitor is very low. In these cases, ripple injection is required to ensure proper operation. Please refer to “Section 5.6, Ripple Injection” for more details about the ripple injection technique.

4.2 Discontinuous Mode (MIC28303-1 Only)

In continuous mode, the inductor current is always greater than zero; however, at light loads, the MIC28303-1 is able to force the inductor current to operate in discontinuous mode. Discontinuous mode is where the inductor current falls to zero, as indicated by trace (I_L) shown in Figure 4-3. During this period, the efficiency is optimized by shutting down all the non-essential circuits and minimizing the supply current. The MIC28303-1 wakes up and turns on the high-side MOSFET when the feedback voltage V_{FB} drops below 0.8V.

The MIC28303-1 has a zero crossing comparator (ZC) that monitors the inductor current by sensing the voltage drop across the low-side MOSFET during its ON-time. If the $V_{FB} > 0.8V$ and the inductor current goes slightly negative, then the MIC28303-1 automatically powers down most of the IC's circuitry and goes into a low-power mode.

Once the MIC28303-1 goes into discontinuous mode, both DL and DH are low, which turns off the high-side and low-side MOSFETs. The load current is supplied by the output capacitors and V_{OUT} drops. If the drop of V_{OUT} causes V_{FB} to go below V_{REF} , then all the circuits will wake up into normal continuous mode. First, the bias currents of most circuits reduced during the discontinuous mode are restored, and then a t_{ON} pulse is triggered before the drivers are turned on to avoid any possible glitches. Finally, the high-side driver is turned on. Figure 4-3 shows the control loop timing in discontinuous mode.

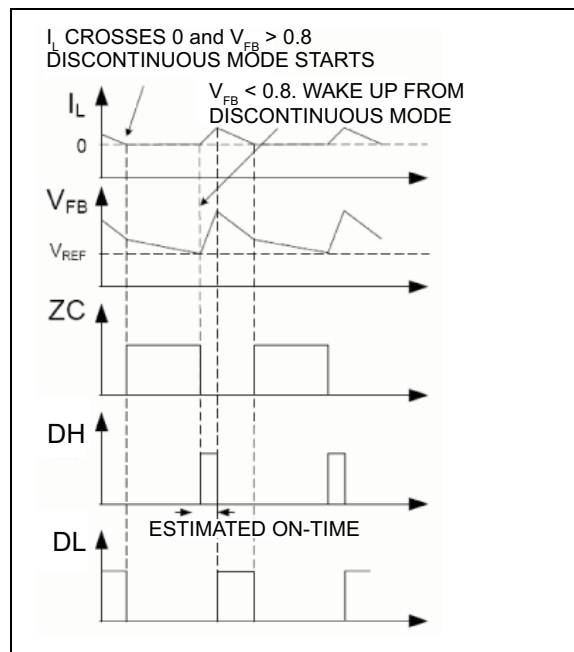

FIGURE 4-3: MIC28303-1 Control Loop Timing (Discontinuous Mode)

During discontinuous mode, the bias current of most circuits is substantially reduced. As a result, the total power supply current during discontinuous mode is only about 400 μA , allowing the MIC28303-1 to achieve high efficiency in light load applications.

4.3 Soft-Start

Soft-start reduces the input power supply surge current at start-up by controlling the output voltage rise time. The input surge appears while the output capacitor is charged up. A slower output rise time will draw a lower input surge current.

The MIC28303 implements an internal digital soft-start by making the 0.8V reference voltage V_{REF} ramp from 0 to 100% in about 5 ms with 9.7 mV steps. Therefore, the output voltage is controlled to increase slowly by a staircase V_{FB} ramp. Once the soft-start cycle ends, the related circuitry is disabled to reduce current consumption. P_{VDD} must be powered up at the same time or after V_{IN} to make the soft-start function correctly.

4.4 Current Limit

The MIC28303 uses the $R_{\text{DS(ON)}}$ of the low side MOSFET and external resistor connected from I_{LIM} pin to SW node to decide the current limit.

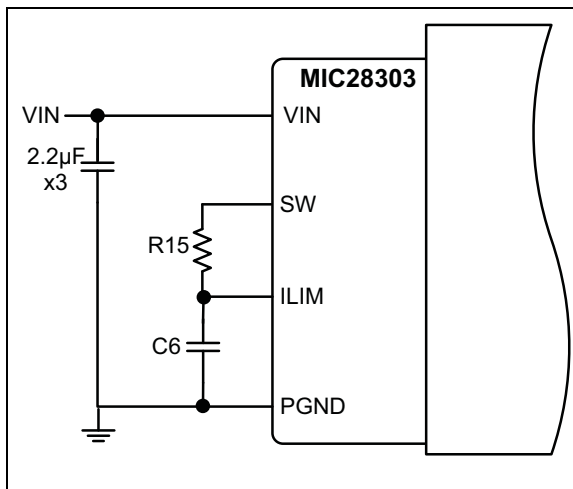

FIGURE 4-4: Current-Limiting Circuit

In each switching cycle of the MIC28303, the inductor current is sensed by monitoring the low-side MOSFET in the OFF period. The sensed voltage $V_{(\text{ILIM})}$ is compared with the power ground (P_{GND}) after a blanking time of 150 ns. In this way, the drop voltage over the resistor R15 (V_{CL}) is compared with the drop over the bottom FET, generating the short current limit. The small capacitor (C6) connected from the I_{LIM} pin to P_{GND} filters the switching node ringing during the OFF-time, allowing a better short limit measurement. The time constant created by R15 and C6 should be much less than the minimum OFF-time.

The V_{CL} drop allows short-limit programming through the value of the resistor (R15), if the absolute value of the voltage drop on the bottom FET is greater than V_{CL} . In that case, the $V_{(\text{ILIM})}$ is lower than P_{GND} and a short circuit event is triggered. A hiccup cycle to treat the short event is generated. The hiccup sequence, including the soft-start, reduces the stress on the switching FETs and protects the load and supply for severe short conditions.

The short-circuit current limit can be programmed by using Equation 4-3.

EQUATION 4-3:

$$R15 = \frac{(I_{\text{CLIM}} - \Delta I_{\text{L(PP)}} \times 0.5) \times R_{\text{DS(ON)}} + V_{\text{CL}}}{I_{\text{CL}}}$$

Where:

I_{CLIM}	Desired Current Limit
$R_{\text{DS(ON)}}$	On-Resistance of Low-Side Power MOSFET, 57 m Ω Typically
V_{CL}	Current-Limit Threshold (Typical Absolute Value is 14 mV per Table 1-1)
I_{CL}	Current-Limit Source Current (Typical Value is 80 μA , per Table 1-1)
$\Delta I_{\text{L(PP)}}$	Inductor Current Peak-to-Peak.

Because the inductor is integrated, use Equation 4-4 to calculate the peak-to-peak inductor ripple current.

EQUATION 4-4:

$$\Delta I_{\text{L(PP)}} = \frac{V_{\text{OUT}} \times (V_{\text{IN(MAX)}} - V_{\text{OUT}})}{V_{\text{IN(MAX)}} \times f_{\text{SW}} \times L}$$

The MIC28303 has 4.7 μH inductor integrated into the module. The typical value of $R_{\text{WINDING(DCR)}}$ of this particular inductor is in the range of 45 m Ω .

In case of hard short, the short limit is folded down to allow an indefinite hard short on the output without any destructive effect. It is mandatory to make sure that the inductor current used to charge the output capacitance during soft start is under the folded short limit; otherwise, the supply will go into hiccup mode and may not finish the soft-start successfully.

The MOSFET $R_{\text{DS(ON)}}$ varies 30%-40% with temperature; therefore, it is recommended to add a 50% margin to I_{CLIM} in Equation 4-3 to avoid false current limiting due to increased MOSFET junction temperature rise. Table 4-1 shows typical output current limit value for a given R15 with C6 = 10 pF.

TABLE 4-1: TYPICAL OUTPUT CURRENT-LIMIT VALUES

R15	Typical Output Current-Limit
1.81 k Ω	3A
2.7 k Ω	6.3A

MIC28303

5.0 APPLICATION INFORMATION

5.1 Simplified Input Transient Circuitry

The 56V absolute maximum rating of the MIC28303 allows simplifying the transient voltage suppressor on the input supply side, which is very common in industrial applications. The input supply voltage V_{IN} (Figure 5-1) may be operating at 12V input rail most of the time, but can encounter a noise spike of 50V for a short duration. By using MIC28303, which has 56V absolute maximum voltage rating, the input transient suppressor is not needed. This saves on component count and form factor, and ultimately the system becomes less expensive.

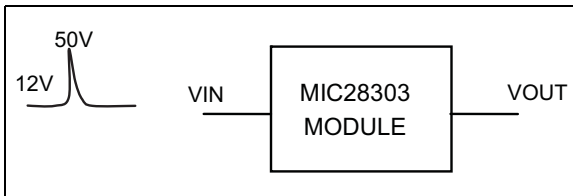

FIGURE 5-1: Simplified Input Transient Circuitry.

5.2 Setting the Switching Frequency

The MIC28303 switching frequency can be adjusted by changing the value of resistor R19. The top resistor of 100 k Ω is internal to module and is connected between V_{IN} and FREQ pin, so the value of R19 sets the switching frequency. The switching frequency also depends on V_{IN} , V_{OUT} and load conditions.

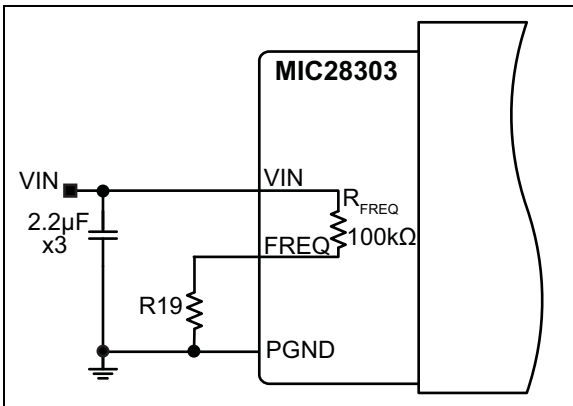

FIGURE 5-2: Switching Frequency Adjustment.

Equation 5-1 gives the estimated switching frequency:

EQUATION 5-1:

$$f_{SW(ADJ)} = f_O \times \frac{R19}{R19 + 100k\Omega}$$

Where:

f_O Switching Frequency When R19 is Open

For more precise setting, it is recommended to use Figure 5-3:

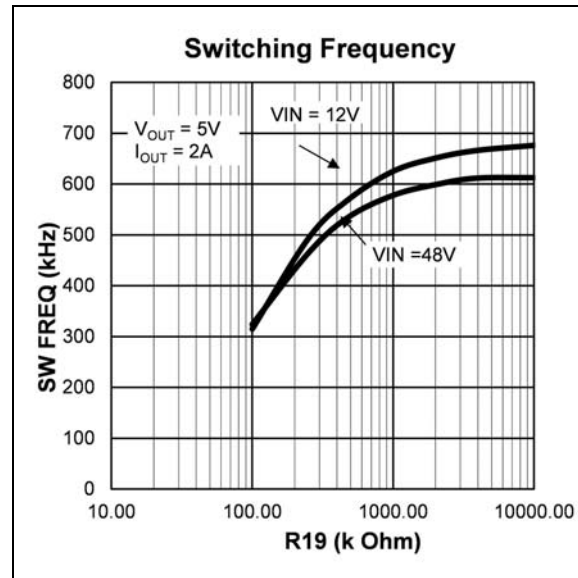

FIGURE 5-3: Switching Frequency vs. R19

5.3 Output Capacitor Selection

The type of the output capacitor is usually determined by the application and its equivalent series resistance (ESR). Voltage and RMS current capability are two other important factors for selecting the output capacitor. Recommended capacitor types are MLCC, tantalum, low-ESR aluminum electrolytic, OS-CON and POSCAP. The output capacitor's ESR is usually the main cause of the output ripple. The MIC28303 requires ripple injection and the output capacitor ESR effects the control loop from a stability point of view.

The maximum value of ESR is calculated as in Equation 5-2:

EQUATION 5-2:

$$ESR_{C_{OUT}} \leq \frac{\Delta V_{OUT(PP)}}{\Delta I_{L(PP)}}$$

Where:

$\Delta V_{OUT(PP)}$ Peak-to-Peak Output Voltage Ripple
 $\Delta I_{L(PP)}$ Peak-to-Peak Inductor Current Ripple

The total output ripple is a combination of the ESR and output capacitance. The total ripple is calculated in [Equation 5-3](#):

EQUATION 5-3:

$$\Delta V_{OUT(PP)} = \sqrt{\left(\frac{\Delta I_{L(PP)}}{C_{OUT} \times f_{SW} \times 8}\right)^2 + (\Delta I_{L(PP)} \times ESR_{C_{OUT}})^2}$$

Where:

D	Duty Cycle
C _{OUT}	Output Capacitance Value
f _{SW}	Switching Frequency

As described in [Section 4.1, Theory of Operation](#), the MIC28303 requires at least 20 mV peak-to-peak ripple at the FB pin to make the g_m amplifier and the error comparator behave properly. Also, the output voltage ripple should be in phase with the inductor current. Therefore, the output voltage ripple caused by the output capacitors value should be much smaller than the ripple caused by the output capacitor ESR. If low-ESR capacitors such as ceramic capacitors are selected as the output capacitors, a ripple injection method should be applied to provide enough feedback voltage ripple. Please refer to [Section 5.6, Ripple Injection](#) for more details.

The voltage rating of the capacitor should be twice the output voltage for a tantalum and 20% greater for aluminum electrolytic or OS-CON.

The output capacitor RMS current is calculated in [Equation 5-4](#):

EQUATION 5-4:

$$I_{C_{OUT}(RMS)} = \frac{\Delta I_{L(PP)}}{\sqrt{12}}$$

The power dissipated in the output capacitor is:

EQUATION 5-5:

$$P_{DISS(C_{OUT})} = I_{C_{OUT}(RMS)}^2 \times ESR_{C_{OUT}}$$

5.4 Input Capacitor Selection

The input capacitor for the power stage input PV_{IN} should be selected for ripple current rating and voltage rating. Tantalum input capacitors may fail when subjected to high inrush currents, caused by turning the input supply on. A tantalum input capacitor's voltage rating should be at least two times the maximum input voltage to maximize reliability. Aluminum electrolytic, OS-CON, and multilayer polymer film capacitors can handle the higher inrush currents without voltage

derating. The input voltage ripple will primarily depend on the input capacitor's ESR. The peak input current is equal to the peak inductor current, so that:

EQUATION 5-6:

$$\Delta V_{IN} = I_{L(pk)} \times ESR_{CIN}$$

The input capacitor must be rated for the input current ripple. The RMS value of input capacitor current is determined at the maximum output current. Assuming the peak-to-peak inductor current ripple is low:

EQUATION 5-7:

$$I_{CIN(RMS)} \approx I_{OUT(MAX)} \times \sqrt{D \times (1 - D)}$$

The power dissipated in the input capacitor is:

EQUATION 5-8:

$$P_{DISS(CIN)} = I_{CIN(RMS)}^2 \times ESR_{CIN}$$

The general rule is to pick the capacitor with a ripple current rating equal to or greater than the calculated worst (V_{IN_MAX}) case RMS capacitor current. Its voltage rating should be 20%-50% higher than the maximum input voltage. Typically the input ripple (d_V) needs to be kept down to less than ±10% of input voltage. The ESR also increases the input ripple.

[Equation 5-9](#) should be used to calculate the input capacitor. Also it is recommended to keep some margin on the calculated value:

EQUATION 5-9:

$$C_{IN} \approx \frac{I_{OUT(MAX)} \times (1 - D)}{f_{SW} \times dV}$$

Where:

dV	Input Ripple
f _{SW}	Switching Frequency

MIC28303

5.5 Output Voltage Setting Components

The MIC28303 requires two resistors to set the output voltage, as shown in [Figure 5-4](#):

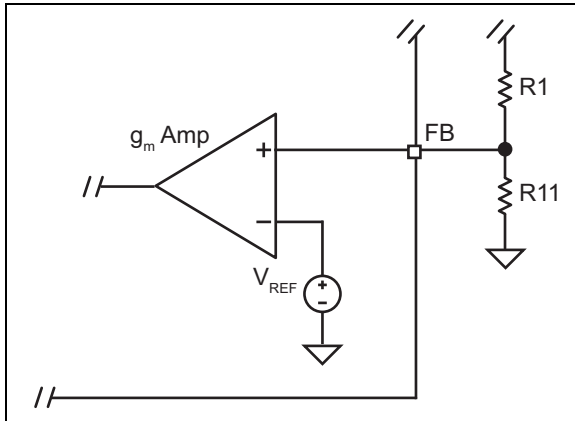

FIGURE 5-4: Voltage-Divider Configuration.

The output voltage is determined by [Equation 5-10](#):

EQUATION 5-10:

$$V_{OUT} = V_{FB} \times \left(1 + \frac{R1}{R11}\right)$$

Where:

$$V_{FB} = 0.8V$$

A typical value of R1 used on the standard evaluation board is 10 kΩ. If R1 is too large, it may allow noise to be introduced into the voltage feedback loop. If R1 is too small in value, it will decrease the efficiency of the power supply, especially at light loads. Once R1 is selected, R11 can be calculated using [Equation 5-11](#):

EQUATION 5-11:

$$R11 = \frac{V_{FB} \times R1}{V_{OUT} - V_{FB}}$$

5.6 Ripple Injection

The V_{FB} ripple required for proper operation of the MIC28303 g_m amplifier and error comparator is 20 mV to 100 mV. However, the output voltage ripple is generally designed as 1%-2% of the output voltage. For a low output voltage, such as a 1V, the output voltage ripple is only 10 mV-20 mV, and the feedback voltage ripple is less than 20 mV. If the feedback voltage ripple is so small that the g_m amplifier and error comparator cannot sense it, then the MIC28303 will lose control and the output voltage is not regulated. In order to have some amount of V_{FB} ripple, a ripple

injection method is applied for low output voltage ripple applications. [Table 2-2](#) summarizes the ripple injection component values for ceramic output capacitor.

The applications are divided into three situations according to the amount of the feedback voltage ripple:

- Enough ripple at the feedback voltage due to the large ESR of the output capacitors ([Figure 5-5](#)):

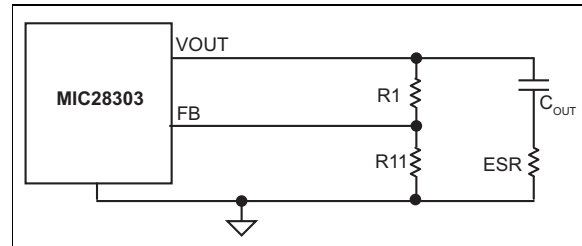

FIGURE 5-5: Enough Ripple at FB.

As shown in [Figure 5-6](#), the converter is stable without any ripple injection.

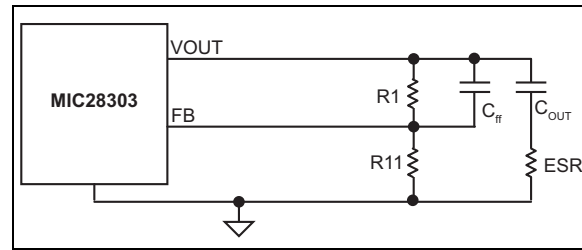

FIGURE 5-6: Inadequate Ripple at FB.

The feedback voltage ripple is:

EQUATION 5-12:

$$\Delta V_{FB(PP)} = \frac{R11}{R1 + R11} \times ESR_{C_{OUT}} \times \Delta I_{L(PP)}$$

Where:

$\Delta I_{L(PP)}$ Peak-to-Peak Value of the Inductor Current Ripple

- Inadequate ripple at the feedback voltage due to the small ESR of the output capacitors, such as the case with ceramic output capacitor.

The output voltage ripple is fed into the FB pin through a feed-forward capacitor, C_{ff} in this situation, as shown in [Figure 5-7](#). The typical C_{ff} value is between 1 nF and 100 nF.

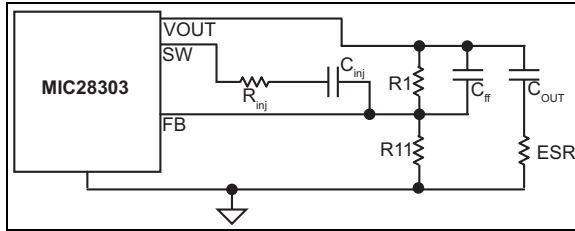

FIGURE 5-7: Invisible Ripple at FB.

With the feed-forward capacitor, the feedback voltage ripple is very close to the output voltage ripple.

EQUATION 5-13:

$$\Delta V_{FB(PP)} \approx ESR \times \Delta I_{L(PP)}$$

- Virtually no ripple at the FB pin voltage due to the very low ESR of the output capacitors.

In this situation, the output voltage ripple is less than 20 mV. Therefore, additional ripple is injected into the FB pin from the switching node SW via a resistor R_{inj} and a capacitor C_{inj} , as shown in [Figure 5-7](#). The injected ripple is:

EQUATION 5-14:

$$\Delta V_{FB(PP)} = V_{IN} \times K_{div} \times D \times (1-D) \times \frac{1}{f_{SW} \times \tau}$$

EQUATION 5-15:

$$K_{div} = \frac{R1 \parallel R11}{R_{inj} + R1 \parallel R11}$$

Where:

V_{IN}	Power Stage Input Voltage
D	Duty Cycle
f_{SW}	Switching Frequency
τ	$(R1 \parallel R11 \parallel R_{inj}) \times C_{ff}$

In [Equation 5-14](#) and [Equation 5-15](#), it is assumed that the time constant associated with C_{ff} must be much greater than the switching period:

EQUATION 5-16:

$$\frac{1}{f_{SW} \times \tau} = \frac{T}{\tau} \ll 1$$

If the voltage divider resistors $R1$ and $R11$ are in the $k\Omega$ range, then a C_{ff} of 1 nF to 100 nF can easily satisfy the large time constant requirements. Also, a 100 nF injection capacitor C_{inj} is used in order to be considered as short for a wide range of the frequencies.

The process of sizing the ripple injection resistor and capacitors is:

1. Select C_{ff} to feed all output ripples into the feedback pin and make sure the large time constant assumption is satisfied. Typical choice of C_{ff} is 1 nF to 100 nF if $R1$ and $R11$ are in the $k\Omega$ range.
2. Select R_{inj} according to the expected feedback voltage ripple using [Equation 5-17](#):

EQUATION 5-17:

$$K_{div} = \frac{\Delta V_{FB(PP)}}{V_{IN}} \times \frac{f_{SW} \times \tau}{D \times (1-D)}$$

Then the value of R_{inj} is obtained as:

EQUATION 5-18:

$$R_{inj} = (R1 \parallel R11) \times \left(\frac{1}{K_{div}} - 1 \right)$$

3. Select C_{inj} as 100 nF, which could be considered as short for a wide range of the frequencies.

[Table 2-2](#) summarizes the typical value of components for particular input and output voltage, and 600 kHz switching frequency design.

5.7 Thermal Measurements and Safe Operating Area

Measuring the IC's case temperature is recommended to ensure it is within its operating limits. Although this may seem like a very elementary task, it is easy to get erroneous results. The most common mistake is to use the standard thermal couple that comes with a thermal meter. This thermal couple wire gauge is large, typically 22-gauge, and behaves like a heat sink, resulting in a lower case measurement.

Two methods of temperature measurement use a smaller thermal couple wire or an infrared thermometer. If a thermal couple wire is used, it must be constructed of 36-gauge wire or higher (smaller wire size) to minimize the wire heat-sinking effect. In addition, the thermal couple tip must be covered in either thermal grease or thermal glue to make sure that the thermal couple junction makes good contact with the case of the IC. Omega brand thermal couple (5SC-TT-K-36-36) is adequate for most applications.

Wherever possible, an infrared thermometer is recommended. The measurement spot size of most infrared thermometers is too large for an accurate reading on small form factor ICs.

However, an IR thermometer from Optris has a 1 mm spot size, which makes it a good choice for measuring the hottest point on the case. An optional stand makes it easy to hold the beam on the IC for long periods of time.

MIC28303

The safe operating area (SOA) of the MIC28303 is shown in the first three graphs of the Typical Characteristics section. These thermal measurements were taken on the MIC28303 evaluation board. Because the MIC28303 is an entire system comprised of switching regulator controller, MOSFETs and inductor, the part needs to be considered a system. The SOA curves will provide guidance for reasonable use of the MIC28303.

5.8 Emission Characteristics of MIC28303

The MIC28303 integrates switching components in a single package, so the MIC28303 has reduced emission compared to a standard buck regulator with external MOSFETs and inductors. The radiated EMI scans for MIC28303 are shown in [Section 2.0, Typical Performance Curves](#). The limit on the graph is per EN55022 Class B standard.

6.0 PCB LAYOUT GUIDELINES

To minimize EMI and output noise, follow these layout recommendations.

PCB layout is critical to achieve reliable, stable and efficient performance. A ground plane is required to control EMI and minimize the inductance in power, signal and return paths.

The following figures optimized from small form factor point of view show top and bottom layers of a four-layer PCB. It is recommended to use mid-layer 1 as a continuous ground plane.

The following guidelines should be followed to ensure proper operation of the MIC28303 converter:

6.1 IC

- The analog ground pin (GND) must be connected directly to the ground planes. Do not route the GND pin to the P_{GND} pin on the top layer.
- Place the IC close to the point-of-load (POL).
- Use fat traces to route the input and output power lines.
- Analog and power grounds should be kept separate and connected at only one location.

6.2 Input Capacitor

- Place the input capacitors on the same side of the board and as close to the IC as possible.
- Place several vias to the ground plane close to the input capacitor ground terminal.
- Use either X7R or X5R dielectric input capacitors. Do not use Y5V or Z5U type capacitors.

- Do not replace the ceramic input capacitor with any other type of capacitor. Any type of capacitor can be placed in parallel with the input capacitor.
- If a Tantalum input capacitor is placed in parallel with the input capacitor, it must be recommended for switching regulator applications and the operating voltage must be derated by 50%.
- In “Hot-Plug” applications, a Tantalum or Electrolytic bypass capacitor must be used to limit the over-voltage spike seen on the input supply with power is suddenly applied.

6.3 RC Snubber

- Place the RC snubber on the same side of the board and as close to the SW pin as possible.

6.4 SW Node

- Do not route any digital lines underneath or close to the SW node.
- Keep the switch node (SW) away from the feedback (FB) pin.

6.5 Output Capacitor

- Use a wide trace to connect the output capacitor ground terminal to the input capacitor ground terminal.
- Phase margin will change as the output capacitor value and ESR changes.
- The feedback trace should be separate from the power trace and connected as close as possible to the output capacitor. Sensing a long high-current load trace can degrade the DC load regulation.

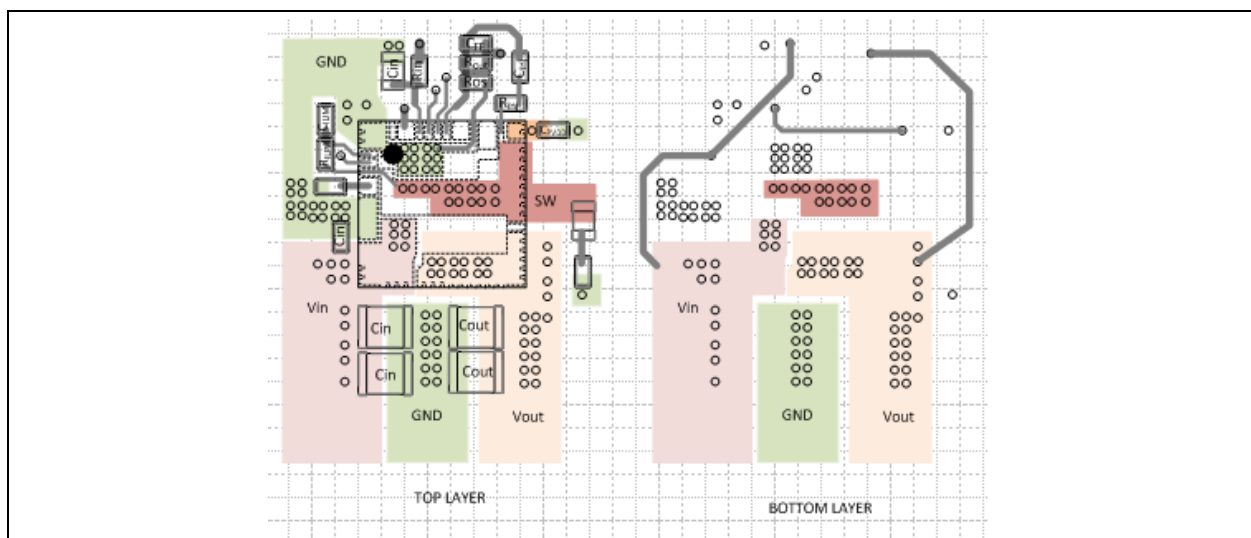

FIGURE 6-1: Top and Bottom Layer of a Four-Layer Board.

MIC28303

7.0 PACKAGING INFORMATION

64-Lead H3QFN 12 mm x 12 mm Package

Note: For the most current package drawings, please see the Microchip Packaging Specification located at <http://www.microchip.com/packaging>

TITLE

64 LEAD H3QFN 12x12mm PACKAGE (Module) OUTLINE & RECOMMENDED LAND PATTERN

DRAWING #	H3QFN1212-64LD-PL-1	UNIT	MM
Lead Frame	Copper	Lead Finish	Matte Tin

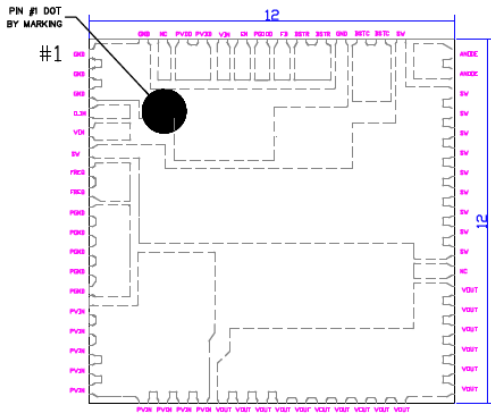

Top View

NOTE: 1, 2, 3

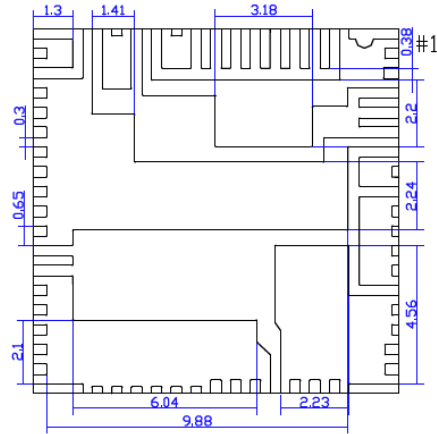

Bottom View

NOTE: 1, 2, 3

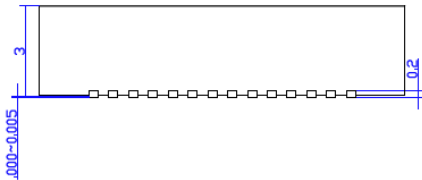

Top View

NOTE: 1, 2, 3

APPENDIX A: REVISION HISTORY

Revision B (October 2017)

- Minor text changes throughout.

Revision A (June 2016)

- Converted Micrel document MIC28303 to Microchip data sheet.
- Minor text changes throughout.

MIC28303

NOTES:

PRODUCT IDENTIFICATION SYSTEM

To order or obtain information, e.g., on pricing or delivery, contact your local Microchip representative or sales office.

<u>PART NO.</u>	<u>-X</u>	<u>X</u>	<u>XX</u>
Device	Features	Temperature	Package
Device: MIC28303:		50V, 3A Power Module	
Features:	1 = HyperLight Load 2 = Hyper Speed Control		
Temperature:	Y = -40°C to +125°C		
Package:	MP = 64-Pin 12 mm x 12 mm QFN		

Examples:

a) MIC28303-1YMP: 50V 3A Power Module, HyperLight Load, -40°C to +125°C junction temperature range, 64LD QFN

b) MIC28303-2YMP: 50V 3A Power Module, Hyper Speed Control, -40°C to +125°C junction temperature range, 64LD QFN

MIC28303

NOTES:

Note the following details of the code protection feature on Microchip devices:

- Microchip products meet the specification contained in their particular Microchip Data Sheet.
- Microchip believes that its family of products is one of the most secure families of its kind on the market today, when used in the intended manner and under normal conditions.
- There are dishonest and possibly illegal methods used to breach the code protection feature. All of these methods, to our knowledge, require using the Microchip products in a manner outside the operating specifications contained in Microchip's Data Sheets. Most likely, the person doing so is engaged in theft of intellectual property.
- Microchip is willing to work with the customer who is concerned about the integrity of their code.
- Neither Microchip nor any other semiconductor manufacturer can guarantee the security of their code. Code protection does not mean that we are guaranteeing the product as “unbreakable.”

Code protection is constantly evolving. We at Microchip are committed to continuously improving the code protection features of our products. Attempts to break Microchip's code protection feature may be a violation of the Digital Millennium Copyright Act. If such acts allow unauthorized access to your software or other copyrighted work, you may have a right to sue for relief under that Act.

Information contained in this publication regarding device applications and the like is provided only for your convenience and may be superseded by updates. It is your responsibility to ensure that your application meets with your specifications. MICROCHIP MAKES NO REPRESENTATIONS OR WARRANTIES OF ANY KIND WHETHER EXPRESS OR IMPLIED, WRITTEN OR ORAL, STATUTORY OR OTHERWISE, RELATED TO THE INFORMATION, INCLUDING BUT NOT LIMITED TO ITS CONDITION, QUALITY, PERFORMANCE, MERCHANTABILITY OR FITNESS FOR PURPOSE. Microchip disclaims all liability arising from this information and its use. Use of Microchip devices in life support and/or safety applications is entirely at the buyer's risk, and the buyer agrees to defend, indemnify and hold harmless Microchip from any and all damages, claims, suits, or expenses resulting from such use. No licenses are conveyed, implicitly or otherwise, under any Microchip intellectual property rights unless otherwise stated.

Microchip received ISO/TS-16949:2009 certification for its worldwide headquarters, design and wafer fabrication facilities in Chandler and Tempe, Arizona; Gresham, Oregon and design centers in California and India. The Company's quality system processes and procedures are for its PIC® MCUs and dsPIC® DSCs, KEELoC® code hopping devices, Serial EEPROMs, microperipherals, nonvolatile memory and analog products. In addition, Microchip's quality system for the design and manufacture of development systems is ISO 9001:2000 certified.

**QUALITY MANAGEMENT SYSTEM
CERTIFIED BY DNV
= ISO/TS 16949 =**

Trademarks

The Microchip name and logo, the Microchip logo, AnyRate, AVR, AVR logo, AVR Freaks, BeaconThings, BitCloud, CryptoMemory, CryptoRF, dsPIC, FlashFlex, flexPWR, Heldo, JukeBlox, KEELoC, KEELoC logo, Klear, LANCheck, LINK MD, maXStylus, maXTouch, MediaLB, megaAVR, MOST, MOST logo, MPLAB, OptoLyzer, PIC, picoPower, PICSTART, PIC32 logo, Prochip Designer, QTouch, RightTouch, SAM-BA, SpyNIC, SST, SST Logo, SuperFlash, tinyAVR, UNI/O, and XMEGA are registered trademarks of Microchip Technology Incorporated in the U.S.A. and other countries.

ClockWorks, The Embedded Control Solutions Company, EtherSynch, Hyper Speed Control, HyperLight Load, IntelliMOS, mTouch, Precision Edge, and Quiet-Wire are registered trademarks of Microchip Technology Incorporated in the U.S.A.

Adjacent Key Suppression, AKS, Analog-for-the-Digital Age, Any Capacitor, AnyIn, AnyOut, BodyCom, chipKIT, chipKIT logo, CodeGuard, CryptoAuthentication, CryptoCompanion, CryptoController, dsPICDEM, dsPICDEM.net, Dynamic Average Matching, DAM, ECAN, EtherGREEN, In-Circuit Serial Programming, ICSP, Inter-Chip Connectivity, JitterBlocker, KlearNet, KlearNet logo, Mindi, MiWi, motorBench, MPASM, MPF, MPLAB Certified logo, MPLIB, MPLINK, MultiTRAK, NetDetach, Omniscient Code Generation, PICDEM, PICDEM.net, PICKit, PICTail, PureSilicon, QMatrix, RightTouch logo, REAL ICE, Ripple Blocker, SAM-ICE, Serial Quad I/O, SMART-I.S., SQI, SuperSwitcher, SuperSwitcher II, Total Endurance, TSHARC, USBCheck, VariSense, ViewSpan, WiperLock, Wireless DNA, and ZENA are trademarks of Microchip Technology Incorporated in the U.S.A. and other countries.

SQTP is a service mark of Microchip Technology Incorporated in the U.S.A.

Silicon Storage Technology is a registered trademark of Microchip Technology Inc. in other countries.

GestIC is a registered trademark of Microchip Technology Germany II GmbH & Co. KG, a subsidiary of Microchip Technology Inc., in other countries.

All other trademarks mentioned herein are property of their respective companies.

© 2017, Microchip Technology Incorporated, All Rights Reserved.
ISBN: 978-1-5224-2260-0



MICROCHIP

Worldwide Sales and Service

AMERICAS

Corporate Office
2355 West Chandler Blvd.
Chandler, AZ 85224-6199
Tel: 480-792-7200
Fax: 480-792-7277
Technical Support:
<http://www.microchip.com/support>
Web Address:
www.microchip.com

Atlanta
Duluth, GA
Tel: 678-957-9614
Fax: 678-957-1455

Austin, TX
Tel: 512-257-3370

Boston
Westborough, MA
Tel: 774-760-0087
Fax: 774-760-0088

Chicago
Itasca, IL
Tel: 630-285-0071
Fax: 630-285-0075

Dallas
Addison, TX
Tel: 972-818-7423
Fax: 972-818-2924

Detroit
Novi, MI
Tel: 248-848-4000

Houston, TX
Tel: 281-894-5983

Indianapolis
Noblesville, IN
Tel: 317-773-8323
Fax: 317-773-5453
Tel: 317-536-2380

Los Angeles
Mission Viejo, CA
Tel: 949-462-9523
Fax: 949-462-9608
Tel: 951-273-7800

Raleigh, NC
Tel: 919-844-7510

New York, NY
Tel: 631-435-6000

San Jose, CA
Tel: 408-735-9110
Tel: 408-436-4270

Canada - Toronto
Tel: 905-695-1980
Fax: 905-695-2078

ASIA/PACIFIC

Asia Pacific Office
Suites 3707-14, 37th Floor
Tower 6, The Gateway
Harbour City, Kowloon

Hong Kong
Tel: 852-2943-5100
Fax: 852-2401-3431

Australia - Sydney
Tel: 61-2-9868-6733
Fax: 61-2-9868-6755

China - Beijing
Tel: 86-10-8569-7000
Fax: 86-10-8528-2104

China - Chengdu
Tel: 86-28-8665-5511
Fax: 86-28-8665-7889

China - Chongqing
Tel: 86-23-8980-9588
Fax: 86-23-8980-9500

China - Dongguan
Tel: 86-769-8702-9880

China - Guangzhou
Tel: 86-20-8755-8029

China - Hangzhou
Tel: 86-571-8792-8115
Fax: 86-571-8792-8116

China - Hong Kong SAR
Tel: 852-2943-5100
Fax: 852-2401-3431

China - Nanjing
Tel: 86-25-8473-2460
Fax: 86-25-8473-2470

China - Qingdao
Tel: 86-532-8502-7355
Fax: 86-532-8502-7205

China - Shanghai
Tel: 86-21-3326-8000
Fax: 86-21-3326-8021

China - Shenyang
Tel: 86-24-2334-2829
Fax: 86-24-2334-2393

China - Shenzhen
Tel: 86-755-8864-2200
Fax: 86-755-8203-1760

China - Wuhan
Tel: 86-27-5980-5300
Fax: 86-27-5980-5118

China - Xian
Tel: 86-29-8833-7252
Fax: 86-29-8833-7256

ASIA/PACIFIC

China - Xiamen
Tel: 86-592-2388138
Fax: 86-592-2388130

China - Zhuhai
Tel: 86-756-3210040
Fax: 86-756-3210049

India - Bangalore
Tel: 91-80-3090-4444
Fax: 91-80-3090-4123

India - New Delhi
Tel: 91-11-4160-8631
Fax: 91-11-4160-8632

India - Pune
Tel: 91-20-3019-1500

Japan - Osaka
Tel: 81-6-6152-7160
Fax: 81-6-6152-9310

Japan - Tokyo
Tel: 81-3-6880-3770
Fax: 81-3-6880-3771

Korea - Daegu
Tel: 82-53-744-4301
Fax: 82-53-744-4302

Korea - Seoul
Tel: 82-2-554-7200
Fax: 82-2-558-5932 or
82-2-558-5934

Malaysia - Kuala Lumpur
Tel: 60-3-6201-9857
Fax: 60-3-6201-9859

Malaysia - Penang
Tel: 60-4-227-8870
Fax: 60-4-227-4068

Philippines - Manila
Tel: 63-2-634-9065
Fax: 63-2-634-9069

Singapore
Tel: 65-6334-8870
Fax: 65-6334-8850

Taiwan - Hsin Chu
Tel: 886-3-5778-366
Fax: 886-3-5770-955

Taiwan - Kaohsiung
Tel: 886-7-213-7830

Taiwan - Taipei
Tel: 886-2-2508-8600
Fax: 886-2-2508-0102

Thailand - Bangkok
Tel: 66-2-694-1351
Fax: 66-2-694-1350

EUROPE

Austria - Wels
Tel: 43-7242-2244-39
Fax: 43-7242-2244-393

Denmark - Copenhagen
Tel: 45-4450-2828
Fax: 45-4485-2829

Finland - Espoo
Tel: 358-9-4520-820

France - Paris
Tel: 33-1-69-53-63-20
Fax: 33-1-69-30-90-79

Germany - Garching
Tel: 49-8931-9700

Germany - Haan
Tel: 49-2129-3766400

Germany - Heilbronn
Tel: 49-7131-67-3636

Germany - Karlsruhe
Tel: 49-721-625370

Germany - Munich
Tel: 49-89-627-144-0
Fax: 49-89-627-144-44

Germany - Rosenheim
Tel: 49-8031-354-560

Israel - Ra'anana
Tel: 972-9-744-7705

Italy - Milan
Tel: 39-0331-742611
Fax: 39-0331-466781

Italy - Padova
Tel: 39-049-7625286

Netherlands - Drunen
Tel: 31-416-690399
Fax: 31-416-690340

Norway - Trondheim
Tel: 47-7289-7561

Poland - Warsaw
Tel: 48-22-3325737

Romania - Bucharest
Tel: 40-21-407-87-50

Spain - Madrid
Tel: 34-91-708-08-90
Fax: 34-91-708-08-91

Sweden - Gothenberg
Tel: 46-31-704-60-40

Sweden - Stockholm
Tel: 46-8-5090-4654

UK - Wokingham
Tel: 44-118-921-5800
Fax: 44-118-921-5820