

Operational Amplifiers

# Low Voltage Operation Ground Sense Operational Amplifier

TLR341G TLR342xxx TLR344xxx

### General Description

TLR341G, TLR342xxx, and TLR344xxx series are single, dual, and quad CMOS operational amplifier with low supply voltage operation and full swing output. These are suitable for battery-operated equipment. The MOSFET input stage provides low input bias current. It can be used for sensor applications. TLR341G includes shutdown function.

### Features

- Low Operating Supply Voltage
- Output Full Swing / Input Ground Sense
- High Large Signal Voltage Gain
- Low Input Bias Current
- Low Supply Current
- Low Input Offset Voltage

### Applications

- Consumer Electronics
- Buffer
- Sensor Amplifier
- Mobile Equipment
- Battery-Operated Equipment

### Key Specifications

- Operating Supply Voltage (Single Supply): +1.8V to +5.5V
- Supply Current:
  - TLR341G 75µA (Typ)
  - TLR342xxx 150µA (Typ)
  - TLR344xxx 300µA (Typ)
- Voltage Gain ( $R_L=2k\Omega$ ): 105dB (Typ)
- Temperature Range: -40°C to +85°C
- Input Offset Voltage: 4mV (Max)
- Input Bias Current: 1pA (Typ)
- Gain Bandwidth: 2.3MHz (Typ)
- Slew Rate: 1.2V/µs (Typ)
- Turn-on Time from Shutdown: 1.2µs (Typ)

### Packages

	W(Typ) x D(Typ) x H(Max)
SSOP6	2.90mm x 2.80mm x 1.25mm
SOP8	5.00mm x 6.20mm x 1.71mm
SOP-J8	4.90mm x 6.00mm x 1.65mm
TSSOP-B8	3.00mm x 6.40mm x 1.20mm
TSSOP-B8J	3.00mm x 4.90mm x 1.10mm
SOP14	8.70mm x 6.20mm x 1.71mm
SOP-J14	8.65mm x 6.00mm x 1.65mm
TSSOP-B14J	5.00mm x 6.40mm x 1.20mm

### Pin Configuration

TLR341G : SSOP6

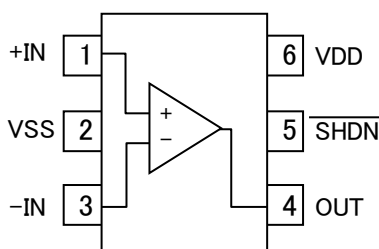

Pin No.	Pin Name
1	+IN
2	VSS
3	-IN
4	OUT
5	SHDN
6	VDD

Pin	Input condition	State
SHDN	V <sub>SS</sub>	Shutdown
	V <sub>DD</sub>	Active

Note: Please refer to Electrical Characteristics regarding to Shutdown Voltage Range.

Pin Configuration – continued

TLR342F : SOP8  
 TLR342FJ : SOP-J8  
 TLR342FVT : TSSOP-B8  
 TLR342FVJ : TSSOP-B8J

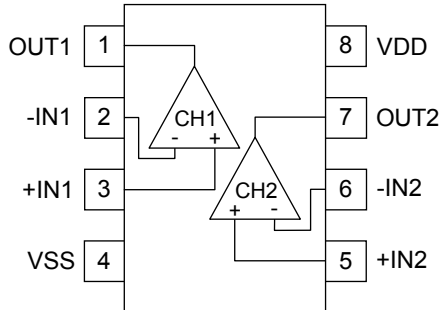

Pin No.	Pin Name
1	OUT1
2	-IN1
3	+IN1
4	VSS
5	+IN2
6	-IN2
7	OUT2
8	VDD

TLR344F : SOP14  
 TLR344FJ : SOP-J14  
 TLR344FVJ : TSSOP-B14J

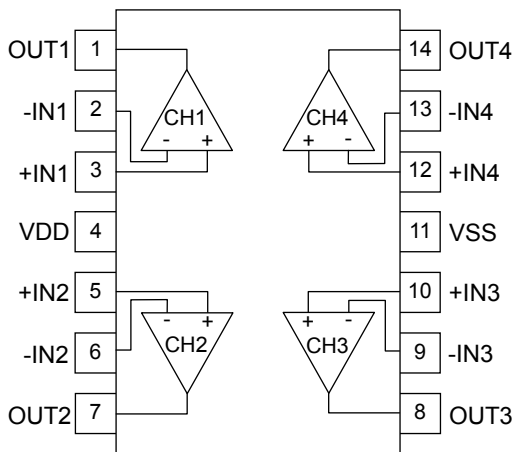

Pin No.	Pin Name
1	OUT1
2	-IN1
3	+IN1
4	VDD
5	+IN2
6	-IN2
7	OUT2
8	OUT3
9	-IN3
10	+IN3
11	VSS
12	+IN4
13	-IN4
14	OUT4

Absolute Maximum Ratings ( $T_A=25^\circ\text{C}$ )

Parameter	Symbol	Rating			Unit	
		TLR341G	TLR342xxx	TLR344xxx		
Supply Voltage	$V_{DD}-V_{SS}$	+7			V	
Power Dissipation	$P_D$	SSOP6	0.67 <sup>(Note 1,9)</sup>	-	-	W
		SOP8	-	0.68 <sup>(Note 2,9)</sup>	-	
		SOP-J8	-	0.67 <sup>(Note 3,9)</sup>	-	
		TSSOP-B8	-	0.62 <sup>(Note 4,9)</sup>	-	
		TSSOP-B8J	-	0.58 <sup>(Note 5,9)</sup>	-	
		SOP14	-	-	0.56 <sup>(Note 6,9)</sup>	
		SOP-J14	-	-	1.02 <sup>(Note 7,9)</sup>	
		TSSOP-B14J	-	-	0.84 <sup>(Note 8,9)</sup>	
Differential Input Voltage <sup>(Note 10)</sup>	$V_{ID}$	$V_{DD} - V_{SS}$			V	
Input Common-mode Voltage Range	$V_{ICM}$	$(V_{SS}-0.3)$ to $(V_{DD}+0.3)$			V	
Input Current <sup>(Note 11)</sup>	$I_I$	$\pm 10$			mA	
Operating Voltage	$V_{opr}$	+1.8 to +5.5			V	
Operating Temperature	$T_{opr}$	-40 to +85			$^\circ\text{C}$	
Storage Temperature	$T_{stg}$	-55 to +150			$^\circ\text{C}$	
Maximum Junction Temperature	$T_{jmax}$	+150			$^\circ\text{C}$	

(Note 1) Power dissipation is reduced by 5.4mW/ $^\circ\text{C}$  above  $T_A=25^\circ\text{C}$ .

(Note 2) Power dissipation is reduced by 5.5mW/ $^\circ\text{C}$  above  $T_A=25^\circ\text{C}$ .

(Note 3) Power dissipation is reduced by 5.4mW/ $^\circ\text{C}$  above  $T_A=25^\circ\text{C}$ .

(Note 4) Power dissipation is reduced by 5.0mW/ $^\circ\text{C}$  above  $T_A=25^\circ\text{C}$ .

(Note 5) Power dissipation is reduced by 4.7mW/ $^\circ\text{C}$  above  $T_A=25^\circ\text{C}$ .

(Note 6) Power dissipation is reduced by 4.5mW/ $^\circ\text{C}$  above  $T_A=25^\circ\text{C}$ .

(Note 7) Power dissipation is reduced by 8.2mW/ $^\circ\text{C}$  above  $T_A=25^\circ\text{C}$ .

(Note 8) Power dissipation is reduced by 6.8mW/ $^\circ\text{C}$  above  $T_A=25^\circ\text{C}$ .

(Note 9) Mounted on a FR4 glass epoxy PCB (70mm×70mm×1.6mm).

(Note 10) Differential Input Voltage is the voltage difference between the inverting and non-inverting inputs.  
The input pin voltage is set to more than  $V_{SS}$ .

(Note 11) An excessive input current will flow when input voltages of more than  $V_{DD}+0.6\text{V}$  or less than  $V_{SS}-0.6\text{V}$  are applied.  
The input current can be set to less than the rated current by adding a limiting resistor.

Caution: Operating the IC over the absolute maximum ratings may damage the IC. The damage can either be a short circuit between pins or an open circuit between pins and the internal circuitry. Therefore, it is important to consider circuit protection measures, such as adding a fuse, in case the IC is operated over the absolute maximum ratings.

## Electrical Characteristics

OTLR341G (Unless otherwise specified  $V_{DD}=+1.8V$ ,  $V_{SS}=0V$ ,  $V_{SHDN}=V_{DD}$ )

Parameter	Symbol	Temperature Range	Limits			Unit	Conditions
			Min	Typ	Max		
Input Offset Voltage <sup>(Note 12,13)</sup>	$V_{IO}$	25°C	-	0.3	4	mV	-
		Full Range	-	-	4.5		
Input Offset Voltage Drift <sup>(Note 12,13)</sup>	$\Delta V_{IO}/\Delta T$	Full Range	-	1.9	-	$\mu V/^\circ C$	-
Input Bias Current <sup>(Note 12)</sup>	$I_B$	25°C	-	1	200	pA	-
Input Offset Current <sup>(Note 12)</sup>	$I_{IO}$	25°C	-	1	200	pA	-
Supply Current <sup>(Note 13)</sup>	$I_{DD}$	25°C	-	70	150	$\mu A$	-
		Full Range	-	-	200		
Shutdown Current	$I_{DD\_SD}$	25°C	-	0.2	1000	nA	$V_{SHDN}=0V$
Common-mode Rejection Ratio	CMRR	25°C	65	90	-	dB	$V_{ICM}=0V$ to 0.7V
Power Supply Rejection Ratio	PSRR	25°C	75	95	-	dB	$V_{DD}=1.8V$ to 5.0V
Input Common-mode Voltage Range	$V_{ICM}$	25°C	0	-	0.8	V	CMRR $\geq$ 60 dB
Large Signal Voltage Gain	$A_V$	25°C	70	110	-	dB	$R_L=10k\Omega$ , $V_{RL}=0.9V$
			65	100	-		$R_L=2k\Omega$ , $V_{RL}=0.9V$
Maximum Output Voltage(High)	$V_{OH}$	25°C	$V_{DD}-0.05$	$V_{DD}-0.03$	-	V	$R_L=2k\Omega$ , $V_{RL}=0.9V$
			$V_{DD}-0.02$	$V_{DD}-0.01$	-		$R_L=10k\Omega$ , $V_{RL}=0.9V$
Maximum Output Voltage(Low)	$V_{OL}$	25°C	-	0.022	0.055	V	$R_L=2k\Omega$ , $V_{RL}=0.9V$
			-	0.014	0.02		$R_L=10k\Omega$ , $V_{RL}=0.9V$
Output Source Current <sup>(Note 14)</sup>	$I_{SOURCE}$	25°C	6	8	-	mA	$V_{OUT}=0V$ , Short Current
Output Sink Current <sup>(Note 14)</sup>	$I_{SINK}$	25°C	10	13	-	mA	$V_{OUT}=1.8V$ , Short Current
Slew Rate	SR	25°C	-	1.2	-	V/ $\mu s$	$R_L=10k\Omega$ , $V_{+IN}=0.7V_{P-P}$
Gain Bandwidth	GBW	25°C	-	2.2	-	MHz	$C_L=200pF$ , $R_L=100k\Omega$
Unity Gain Frequency	$f_T$	25°C	-	1.2	-	MHz	$C_L=200pF$ , $R_L=100k\Omega$
Phase Margin	$\theta_M$	25°C	-	55	-	deg	$C_L=20pF$ , $R_L=100k\Omega$
Gain Margin	GM	25°C	-	7	-	dB	$C_L=20pF$ , $R_L=100k\Omega$
Input Referred Noise Voltage	$V_N$	25°C	-	33	-	nV/ $\sqrt{Hz}$	f=1kHz
Total Harmonic Distortion + Noise	THD+N	25°C	-	0.012	-	%	f=1kHz, $R_L=600\Omega$ $A_v=0dB$ , DIN-AUDIO
Turn-on Time from Shutdown	$t_{ON}$	25°C	-	1.8	-	$\mu s$	-
Shutdown Voltage Range	$V_{SHDN\_H}$	25°C	1.5	-	1.8	V	(Note 15)
	$V_{SHDN\_L}$		0	-	0.5	V	(Note 16)

(Note 12) Absolute value

(Note 13) Full Range:  $T_A=-40^\circ C$  to  $+85^\circ C$

(Note 14) Consider the power dissipation of the IC under high temperature environment when selecting the output current value.

There may be a case where the output current value is reduced due to the rise in IC temperature caused by the heat generated inside the IC.

(Note 15) This voltage range means active condition.

(Note 16) This voltage range means shutdown condition.

## Electrical Characteristics – continued

OTLR341G (Unless otherwise specified  $V_{DD}=+5V$ ,  $V_{SS}=0V$ ,  $V_{SHDN}=V_{DD}$ )

Parameter	Symbol	Temperature Range	Limits			Unit	Conditions
			Min	Typ	Max		
Input Offset Voltage <sup>(Note 17,18)</sup>	$V_{IO}$	25°C	-	0.3	4	mV	-
		Full Range	-	-	4.5		
Input Offset Voltage Drift <sup>(Note 17,18)</sup>	$\Delta V_{IO}/\Delta T$	Full Range	-	1.9	-	$\mu V/^\circ C$	-
Input Bias Current <sup>(Note 17)</sup>	$I_B$	25°C	-	1	200	pA	-
Input Offset Current <sup>(Note 17)</sup>	$I_{IO}$	25°C	-	1	200	pA	-
Supply Current <sup>(Note 18)</sup>	$I_{DD}$	25°C	-	75	150	$\mu A$	-
		Full Range	-	-	200		
Shutdown Current	$I_{DD\_SD}$	25°C	-	0.2	1000	nA	$V_{SHDN}=0V$
Common-mode Rejection Ratio	CMRR	25°C	75	90	-	dB	$V_{ICM}=0V$ to 3.9V
Power Supply Rejection Ratio	PSRR	25°C	75	95	-	dB	$V_{DD}=1.8V$ to 5.0V
Input Common-mode Voltage Range	$V_{ICM}$	25°C	0	-	4.0	V	CMRR $\geq 70$ dB
Large Signal Voltage Gain	$A_V$	25°C	80	110	-	dB	$R_L=10k\Omega$ , $V_{RL}=2.5V$
			75	105	-		$R_L=2k\Omega$ , $V_{RL}=2.5V$
Maximum Output Voltage(High)	$V_{OH}$	25°C	$V_{DD}-0.06$	$V_{DD}-0.03$	-	V	$R_L=2k\Omega$ , $V_{RL}=2.5V$
			$V_{DD}-0.02$	$V_{DD}-0.01$	-		$R_L=10k\Omega$ , $V_{RL}=2.5V$
Maximum Output Voltage(Low)	$V_{OL}$	25°C	-	0.04	0.06	V	$R_L=2k\Omega$ , $V_{RL}=2.5V$
			-	0.02	0.03		$R_L=10k\Omega$ , $V_{RL}=2.5V$
Output Source Current <sup>(Note 19)</sup>	$I_{SOURCE}$	25°C	60	100	-	mA	$V_{OUT}=0V$ , Short Current
Output Sink Current <sup>(Note 19)</sup>	$I_{SINK}$	25°C	80	120	-	mA	$V_{OUT}=5V$ , Short Current
Slew Rate	SR	25°C	-	1.2	-	V/ $\mu s$	$R_L=10k\Omega$ , $V_{+IN}=2V_{P-P}$
Gain Bandwidth	GBW	25°C	-	2.3	-	MHz	$C_L=200pF$ , $R_L=100k\Omega$
Unity Gain Frequency	$f_T$	25°C	-	1.3	-	MHz	$C_L=200pF$ , $R_L=100k\Omega$
Phase Margin	$\theta_M$	25°C	-	55	-	deg	$C_L=20pF$ , $R_L=100k\Omega$
Gain Margin	GM	25°C	-	7	-	dB	$C_L=20pF$ , $R_L=100k\Omega$
Input Referred Noise Voltage	$V_N$	25°C	-	33	-	nV/ $\sqrt{Hz}$	f=1kHz
Total Harmonic Distortion + Noise	THD+N	25°C	-	0.012	-	%	$V_{+IN}=1V_{P-P}$ , f=1kHz $R_L=600\Omega$ , $A_V=0dB$ , DIN-AUDIO
Turn-on Time from Shutdown	$t_{ON}$	25°C	-	1.2	-	$\mu s$	-
Shutdown Voltage Range	$V_{SHDN\_H}$	25°C	4.5	-	5.0	V	(Note 20)
	$V_{SHDN\_L}$		0	-	0.8	V	(Note 21)

(Note 17) Absolute value

(Note 18) Full Range:  $T_A=-40^\circ C$  to  $+85^\circ C$ 

(Note 19) Consider the power dissipation of the IC under high temperature environment when selecting the output current value.

There may be a case where the output current value is reduced due to the rise in IC temperature caused by the heat generated inside the IC.

(Note 20) This voltage range means active condition.

(Note 21) This voltage range means shutdown condition.

## Electrical Characteristics – continued

OTLR342xxx (Unless otherwise specified  $V_{DD}=+1.8V$ ,  $V_{SS}=0V$ )

Parameter	Symbol	Temperature Range	Limit			Unit	Conditions
			Min	Typ	Max		
Input Offset Voltage <sup>(Note 22,23)</sup>	$V_{IO}$	25°C	-	0.3	4	mV	-
		Full Range	-	-	4.5		
Input Offset Voltage Drift <sup>(Note 22,23)</sup>	$\Delta V_{IO}/\Delta T$	Full Range	-	1.9	-	$\mu V/^\circ C$	-
Input Bias Current <sup>(Note 22)</sup>	$I_B$	25°C	-	1	200	pA	-
Input Offset Current <sup>(Note 22)</sup>	$I_{IO}$	25°C	-	1	200	pA	-
Supply Current <sup>(Note 23)</sup>	$I_{DD}$	25°C	-	150	300	$\mu A$	-
		Full Range	-	-	400		
Common-mode Rejection Ratio	CMRR	25°C	65	90	-	dB	$V_{ICM}=0V$ to 0.7V
Power Supply Rejection Ratio	PSRR	25°C	75	95	-	dB	$V_{DD}=1.8V$ to 5.0V
Input Common-mode Voltage Range	$V_{ICM}$	25°C	0	-	0.8	V	CMRR $\geq$ 60 dB
Large Signal Voltage Gain	$A_V$	25°C	70	110	-	dB	$R_L=10k\Omega$ , $V_{RL}=0.9V$
			65	100	-		$R_L=2k\Omega$ , $V_{RL}=0.9V$
Maximum Output Voltage(High)	$V_{OH}$	25°C	$V_{DD}-0.05$	$V_{DD}-0.03$	-	V	$R_L=2k\Omega$ , $V_{RL}=0.9V$
			$V_{DD}-0.02$	$V_{DD}-0.01$	-		$R_L=10k\Omega$ , $V_{RL}=0.9V$
Maximum Output Voltage(Low)	$V_{OL}$	25°C	-	0.022	0.055	V	$R_L=2k\Omega$ , $V_{RL}=0.9V$
			-	0.014	0.02		$R_L=10k\Omega$ , $V_{RL}=0.9V$
Output Source Current <sup>(Note 24)</sup>	$I_{SOURCE}$	25°C	6	8	-	mA	$V_{OUT}=0V$ , Short Current
Output Sink Current <sup>(Note 24)</sup>	$I_{SINK}$	25°C	10	13	-	mA	$V_{OUT}=1.8V$ , Short Current
Slew Rate	SR	25°C	-	1.2	-	V/ $\mu s$	$R_L=10k\Omega$ , $V_{+IN}=0.7V_{P-P}$
Gain Bandwidth	GBW	25°C	-	2.2	-	MHz	$C_L=200pF$ , $R_L=100k\Omega$
Unity Gain Frequency	$f_T$	25°C	-	1.2	-	MHz	$C_L=200pF$ , $R_L=100k\Omega$
Phase Margin	$\theta_M$	25°C	-	55	-	deg	$C_L=20pF$ , $R_L=100k\Omega$
Gain Margin	GM	25°C	-	7	-	dB	$C_L=20pF$ , $R_L=100k\Omega$
Input Referred Noise Voltage	$V_N$	25°C	-	33	-	$nV/\sqrt{Hz}$	$f=1kHz$
Total Harmonic Distortion + Noise	THD+N	25°C	-	0.012	-	%	$f=1kHz$ , $R_L=600\Omega$ $A_V=0dB$ , DIN-AUDIO
Channel Separation	CS	25°C	-	110	-	dB	$A_V=40dB$ , $V_{OUT}=1V_{rms}$

(Note 22) Absolute value

(Note 23) Full Range:  $T_A=-40^\circ C$  to  $+85^\circ C$ 

(Note 24) Consider the power dissipation of the IC under high temperature environment when selecting the output current value.

There may be a case where the output current value is reduced due to the rise in IC temperature caused by the heat generated inside the IC.

## Electrical Characteristics – continued

OTLR342xxx (Unless otherwise specified  $V_{DD}=+5V$ ,  $V_{SS}=0V$ )

Parameter	Symbol	Temperature Range	Limit			Unit	Conditions
			Min	Typ	Max		
Input Offset Voltage <sup>(Note 25,26)</sup>	$V_{IO}$	25°C	-	0.3	4	mV	-
		Full Range	-	-	4.5		
Input Offset Voltage Drift <sup>(Note 25,26)</sup>	$\Delta V_{IO}/\Delta T$	Full Range	-	1.9	-	$\mu V/^\circ C$	-
Input Bias Current <sup>(Note 25)</sup>	$I_B$	25°C	-	1	200	pA	-
Input Offset Current <sup>(Note 25)</sup>	$I_{IO}$	25°C	-	1	200	pA	-
Supply Current <sup>(Note 26)</sup>	$I_{DD}$	25°C	-	150	300	$\mu A$	-
		Full Range	-	-	400		
Common-mode Rejection Ratio	CMRR	25°C	75	90	-	dB	$V_{ICM}=0V$ to 3.9V
Power Supply Rejection Ratio	PSRR	25°C	75	95	-	dB	$V_{DD}=1.8V$ to 5.0V
Input Common-mode Voltage Range	$V_{ICM}$	25°C	0	-	4.0	V	CMRR $\geq 70$ dB
Large Signal Voltage Gain	$A_V$	25°C	80	110	-	dB	$R_L=10k\Omega$ , $V_{RL}=2.5V$
			75	105	-		$R_L=2k\Omega$ , $V_{RL}=2.5V$
Maximum Output Voltage(High)	$V_{OH}$	25°C	$V_{DD}-0.06$	$V_{DD}-0.03$	-	V	$R_L=2k\Omega$ , $V_{RL}=2.5V$
			$V_{DD}-0.02$	$V_{DD}-0.01$	-		$R_L=10k\Omega$ , $V_{RL}=2.5V$
Maximum Output Voltage(Low)	$V_{OL}$	25°C	-	0.04	0.06	V	$R_L=2k\Omega$ , $V_{RL}=2.5V$
			-	0.02	0.03		$R_L=10k\Omega$ , $V_{RL}=2.5V$
Output Source Current <sup>(Note 27)</sup>	$I_{SOURCE}$	25°C	60	100	-	mA	$V_{OUT}=0V$ , Short Current
Output Sink Current <sup>(Note 27)</sup>	$I_{SINK}$	25°C	80	120	-	mA	$V_{OUT}=5V$ , Short Current
Slew Rate	SR	25°C	-	1.2	-	V/ $\mu s$	$R_L=10k\Omega$ , $V_{+IN}=2V_{P-P}$
Gain Bandwidth	GBW	25°C	-	2.3	-	MHz	$C_L=200pF$ , $R_L=100k\Omega$
Unity Gain Frequency	$f_T$	25°C	-	1.3	-	MHz	$C_L=200pF$ , $R_L=100k\Omega$
Phase Margin	$\theta_M$	25°C	-	55	-	deg	$C_L=20pF$ , $R_L=100k\Omega$
Gain Margin	GM	25°C	-	7	-	dB	$C_L=20pF$ , $R_L=100k\Omega$
Input Referred Noise Voltage	$V_N$	25°C	-	33	-	nV/ $\sqrt{Hz}$	f=1kHz
Total Harmonic Distortion + Noise	THD+N	25°C	-	0.012	-	%	$V_{+IN}=1V_{P-P}$ , f=1kHz $R_L=600\Omega$ , $A_V=0dB$ , DIN-AUDIO
Channel Separation	CS	25°C	-	110	-	dB	$A_V=40dB$ , $V_{OUT}=1V_{rms}$

(Note 25) Absolute value

(Note 26) Full Range:  $T_A=-40^\circ C$  to  $+85^\circ C$ 

(Note 27) Consider the power dissipation of the IC under high temperature environment when selecting the output current value.

There may be a case where the output current value is reduced due to the rise in IC temperature caused by the heat generated inside the IC.

## Electrical Characteristics – continued

OTLR344xxx (Unless otherwise specified  $V_{DD}=+1.8V$ ,  $V_{SS}=0V$ )

Parameter	Symbol	Temperature Range	Limit			Unit	Conditions
			Min	Typ	Max		
Input Offset Voltage <sup>(Note 28,29)</sup>	$V_{IO}$	25°C	-	0.3	4	mV	-
		Full Range	-	-	4.5		
Input Offset Voltage Drift <sup>(Note 28,29)</sup>	$\Delta V_{IO}/\Delta T$	Full Range	-	1.9	-	$\mu V/^\circ C$	-
Input Bias Current <sup>(Note 28)</sup>	$I_B$	25°C	-	1	200	pA	-
Input Offset Current <sup>(Note 28)</sup>	$I_{IO}$	25°C	-	1	200	pA	-
Supply Current <sup>(Note 29)</sup>	$I_{DD}$	25°C	-	280	600	$\mu A$	-
		Full Range	-	-	800		
Common-mode Rejection Ratio	CMRR	25°C	65	90	-	dB	$V_{ICM}=0V$ to 0.7V
Power Supply Rejection Ratio	PSRR	25°C	75	95	-	dB	$V_{DD}=1.8V$ to 5.0V
Input Common-mode Voltage Range	$V_{ICM}$	25°C	0	-	0.8	V	CMRR $\geq$ 60 dB
Large Signal Voltage Gain	$A_V$	25°C	70	110	-	dB	$R_L=10k\Omega$ , $V_{RL}=0.9V$
			65	100	-		$R_L=2k\Omega$ , $V_{RL}=0.9V$
Maximum Output Voltage(High)	$V_{OH}$	25°C	$V_{DD}-0.05$	$V_{DD}-0.03$	-	V	$R_L=2k\Omega$ , $V_{RL}=0.9V$
			$V_{DD}-0.02$	$V_{DD}-0.01$	-		$R_L=10k\Omega$ , $V_{RL}=0.9V$
Maximum Output Voltage(Low)	$V_{OL}$	25°C	-	0.022	0.055	V	$R_L=2k\Omega$ , $V_{RL}=0.9V$
			-	0.014	0.02		$R_L=10k\Omega$ , $V_{RL}=0.9V$
Output Source Current <sup>(Note 30)</sup>	$I_{SOURCE}$	25°C	6	8	-	mA	$V_{OUT}=0V$ , Short Current
Output Sink Current <sup>(Note 30)</sup>	$I_{SINK}$	25°C	10	13	-	mA	$V_{OUT}=1.8V$ , Short Current
Slew Rate	SR	25°C	-	1.2	-	V/ $\mu s$	$R_L=10k\Omega$ , $V_{+IN}=0.7V_{P-P}$
Gain Bandwidth	GBW	25°C	-	2.2	-	MHz	$C_L=200pF$ , $R_L=100k\Omega$
Unity Gain Frequency	$f_T$	25°C	-	1.2	-	MHz	$C_L=200pF$ , $R_L=100k\Omega$
Phase Margin	$\theta_M$	25°C	-	55	-	deg	$C_L=20pF$ , $R_L=100k\Omega$
Gain Margin	GM	25°C	-	7	-	dB	$C_L=20pF$ , $R_L=100k\Omega$
Input Referred Noise Voltage	$V_N$	25°C	-	33	-	$nV/\sqrt{Hz}$	$f=1kHz$
Total Harmonic Distortion + Noise	THD+N	25°C	-	0.012	-	%	$f=1kHz$ , $R_L=600\Omega$ $A_V=0dB$ , DIN-AUDIO
Channel Separation	CS	25°C	-	110	-	dB	$A_V=40dB$ , $V_{OUT}=1V_{rms}$

(Note 28) Absolute value

(Note 29) Full Range:  $T_A=-40^\circ C$  to  $+85^\circ C$ 

(Note 30) Consider the power dissipation of the IC under high temperature environment when selecting the output current value.

There may be a case where the output current value is reduced due to the rise in IC temperature caused by the heat generated inside the IC.



## Electrical Characteristics – continued

OTLR344xxx (Unless otherwise specified  $V_{DD}=+5V$ ,  $V_{SS}=0V$ )

Parameter	Symbol	Temperature Range	Limit			Unit	Conditions
			Min	Typ	Max		
Input Offset Voltage <sup>(Note 31,32)</sup>	$V_{IO}$	25°C	-	0.3	4	mV	-
		Full Range	-	-	4.5		
Input Offset Voltage Drift <sup>(Note 31,32)</sup>	$\Delta V_{IO}/\Delta T$	Full Range	-	1.9	-	$\mu V/^\circ C$	-
Input Bias Current <sup>(Note 31)</sup>	$I_B$	25°C	-	1	200	pA	-
Input Offset Current <sup>(Note 31)</sup>	$I_{IO}$	25°C	-	1	200	pA	-
Supply Current <sup>(Note 32)</sup>	$I_{DD}$	25°C	-	300	600	$\mu A$	-
		Full Range	-	-	800		
Common-mode Rejection Ratio	CMRR	25°C	75	90	-	dB	$V_{ICM}=0V$ to 3.9V
Power Supply Rejection Ratio	PSRR	25°C	75	95	-	dB	$V_{DD}=1.8V$ to 5.0V
Input Common-mode Voltage Range	$V_{ICM}$	25°C	0	-	4.0	V	CMRR $\geq 70$ dB
Large Signal Voltage Gain	$A_V$	25°C	80	110	-	dB	$R_L=10k\Omega$ , $V_{RL}=2.5V$
			75	105	-		$R_L=2k\Omega$ , $V_{RL}=2.5V$
Maximum Output Voltage(High)	$V_{OH}$	25°C	$V_{DD}-0.06$	$V_{DD}-0.03$	-	V	$R_L=2k\Omega$ , $V_{RL}=2.5V$
			$V_{DD}-0.02$	$V_{DD}-0.01$	-		$R_L=10k\Omega$ , $V_{RL}=2.5V$
Maximum Output Voltage(Low)	$V_{OL}$	25°C	-	0.04	0.06	V	$R_L=2k\Omega$ , $V_{RL}=2.5V$
			-	0.02	0.03		$R_L=10k\Omega$ , $V_{RL}=2.5V$
Output Source Current <sup>(Note 33)</sup>	$I_{SOURCE}$	25°C	60	100	-	mA	$V_{OUT}=0V$ , Short Current
Output Sink Current <sup>(Note 33)</sup>	$I_{SINK}$	25°C	80	120	-	mA	$V_{OUT}=5V$ , Short Current
Slew Rate	SR	25°C	-	1.2	-	V/ $\mu s$	$R_L=10k\Omega$ , $V_{+IN}=2V_{P-P}$
Gain Bandwidth	GBW	25°C	-	2.3	-	MHz	$C_L=200pF$ , $R_L=100k\Omega$
Unity Gain Frequency	$f_T$	25°C	-	1.3	-	MHz	$C_L=200pF$ , $R_L=100k\Omega$
Phase Margin	$\theta_M$	25°C	-	55	-	deg	$C_L=20pF$ , $R_L=100k\Omega$
Gain Margin	GM	25°C	-	7	-	dB	$C_L=20pF$ , $R_L=100k\Omega$
Input Referred Noise Voltage	$V_N$	25°C	-	33	-	$nV/\sqrt{Hz}$	$f=1kHz$
Total Harmonic Distortion + Noise	THD+N	25°C	-	0.012	-	%	$V_{+IN}=1V_{P-P}$ , $f=1kHz$ $R_L=600\Omega$ , $A_V=0dB$ , DIN-AUDIO
Channel Separation	CS	25°C	-	110	-	dB	$A_V=40dB$ , $V_{OUT}=1V_{rms}$

(Note 31) Absolute value

(Note 32) Full Range:  $T_A=-40^\circ C$  to  $+85^\circ C$ 

(Note 33) Consider the power dissipation of the IC under high temperature environment when selecting the output current value.

There may be a case where the output current value is reduced due to the rise in IC temperature caused by the heat generated inside the IC.

## Description of Electrical Characteristics

Described below are descriptions of the relevant electrical terms used in this datasheet. Items and symbols used are also shown. Note that item name and symbol and their meaning may differ from those on another manufacturer's document or general document.

### 1. Absolute Maximum Ratings

Absolute maximum rating items indicate the condition which must not be exceeded. Application of voltage in excess of absolute maximum rating or use out of absolute maximum rated temperature environment may cause deterioration of characteristics.

- (1) Supply Voltage ( $V_{DD}/V_{SS}$ )  
Indicates the maximum voltage that can be applied between the VDD pin and VSS pin without deterioration or destruction of characteristics of internal circuit.
- (2) Differential Input Voltage ( $V_{ID}$ )  
Indicates the maximum voltage that can be applied between non-inverting and inverting pins without damaging the IC.
- (3) Input Common-mode Voltage Range ( $V_{ICM}$ )  
Indicates the maximum voltage that can be applied to the non-inverting and inverting pins without deterioration or destruction of electrical characteristics. Input common-mode voltage range of the maximum ratings does not assure normal operation of IC. For normal operation, use the IC within the input common-mode voltage range characteristics.
- (4) Power Dissipation ( $P_D$ )  
Indicates the power that can be consumed by the IC when mounted on a specific board at the ambient temperature 25°C (normal temperature). As for package product,  $P_D$  is determined by the temperature that can be permitted by the IC in the package (maximum junction temperature) and the thermal resistance of the package.

### 2. Electrical Characteristics

- (1) Input Offset Voltage ( $V_{IO}$ )  
Indicates the voltage difference between non-inverting pin and inverting pins. It can be translated into the input voltage difference required for setting the output voltage at 0V.
- (2) Input Offset Voltage drift ( $\Delta V_{IO}/\Delta T$ )  
Denotes the ratio of the input offset voltage fluctuation to the ambient temperature fluctuation.
- (3) Input Offset Current ( $I_{IO}$ )  
Indicates the difference of input bias current between the non-inverting and inverting pins.
- (4) Input Bias Current ( $I_B$ )  
Indicates the current that flows into or out of the input pin. It is defined by the average of input bias currents at the non-inverting and inverting pins.
- (5) Supply Current ( $I_{DD}$ )  
Indicates the current that flows within the IC under specified no-load conditions.
- (6) Shutdown current ( $I_{DD\_SD}$ )  
Indicates the current when the circuit is shutdown.
- (7) Maximum Output Voltage(High) / Maximum Output Voltage(Low) ( $V_{OH}/V_{OL}$ )  
Indicates the voltage range of the output under specified load condition. It is typically divided into maximum output voltage high and low. Maximum output voltage high indicates the upper limit of output voltage. Maximum output voltage low indicates the lower limit.
- (8) Large Signal Voltage Gain ( $A_V$ )  
Indicates the amplifying rate (gain) of output voltage against the voltage difference between non-inverting pin and inverting pin. It is normally the amplifying rate (gain) with reference to DC voltage.  
 $A_V = (\text{Output Voltage}) / (\text{Differential Input Voltage})$
- (9) Input Common-mode Voltage Range ( $V_{ICM}$ )  
Indicates the input voltage range where IC normally operates.
- (10) Common-mode Rejection Ratio (CMRR)  
Indicates the ratio of fluctuation of input offset voltage when the input common-mode voltage is changed. It is normally the fluctuation of DC.  
 $CMRR = (\text{Change of Input Common-mode voltage}) / (\text{Input offset fluctuation})$
- (11) Power Supply Rejection Ratio (PSRR)  
Indicates the ratio of fluctuation of input offset voltage when supply voltage is changed.  
It is normally the fluctuation of DC.  
 $PSRR = (\text{Change of power supply voltage}) / (\text{Input offset fluctuation})$
- (12) Output Source Current/ Output Sink Current ( $I_{SOURCE} / I_{SINK}$ )  
The maximum current that can be output from the IC under specific output conditions. The output source current indicates the current flowing out from the IC, and the output sink current indicates the current flowing into the IC.
- (13) Slew Rate (SR)  
Indicates the ratio of the change in output voltage with time when a step input signal is applied.
- (14) Unity Gain Frequency ( $f_T$ )  
Indicates a frequency where the voltage gain of operational amplifier is 1.
- (15) Gain Bandwidth (GBW)  
The product of the open-loop voltage gain and the frequency at which the voltage gain decreases 6dB/octave.

**Description of Electrical Characteristics - continued**

- (16) Phase Margin ( $\theta_M$ )  
Indicates the margin of phase from 180 degree phase lag at unity gain frequency.
- (17) Gain Margin (GM)  
Indicates the difference between 0dB and the gain where operational amplifier has 180 degree phase delay.
- (18) Input Referred Noise Voltage ( $V_N$ )  
Indicates a noise voltage generated inside the operational amplifier equivalent by ideal voltage source connected in series with input pin.
- (19) Total Harmonic Distortion + Noise (THD+N)  
Indicates the fluctuation of input offset voltage or that of output voltage with reference to the change of output voltage of driven channel.
- (20) Channel Separation (CS)  
Indicates the fluctuation in the output voltage of the driven channel with reference to the change of output voltage of the channel which is not driven.
- (21) Turn On Time From Shutdown ( $t_{ON}$ )  
Indicates the time from applying the voltage to shutdown terminal until the IC is active.
- (22) Turn On Voltage / Turn Off Voltage ( $V_{SHDN\_H}$  /  $V_{SHDN\_L}$ )  
The IC is active if the shutdown terminal is applied more than Turn On Voltage ( $V_{SHDN\_H}$ ).  
The IC is shutdown if the shutdown terminal is applied less than Turn Off Voltage ( $V_{SHDN\_L}$ ).

Typical Performance Curves

OTLR341G

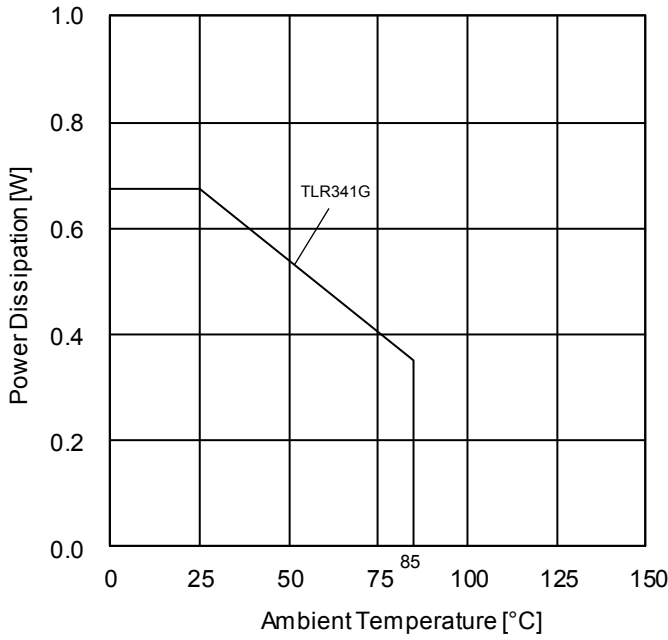

Figure 1. Power Dissipation vs Ambient Temperature (Derating Curve)

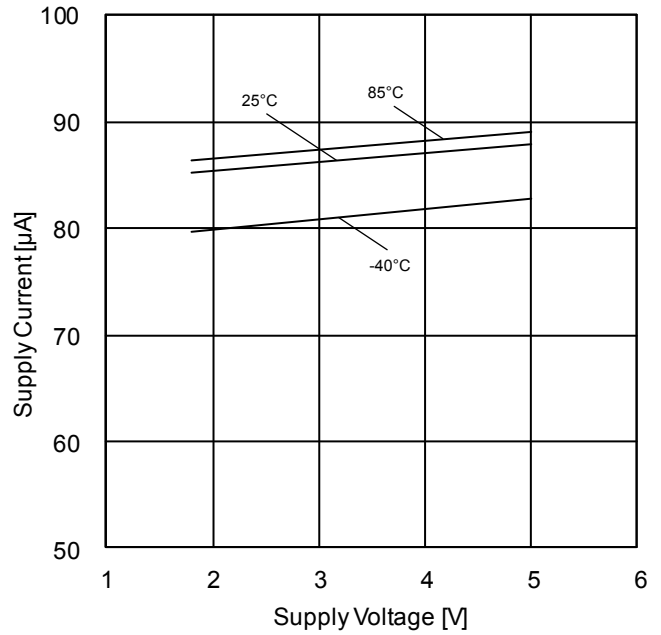

Figure 2. Supply Current vs Supply Voltage

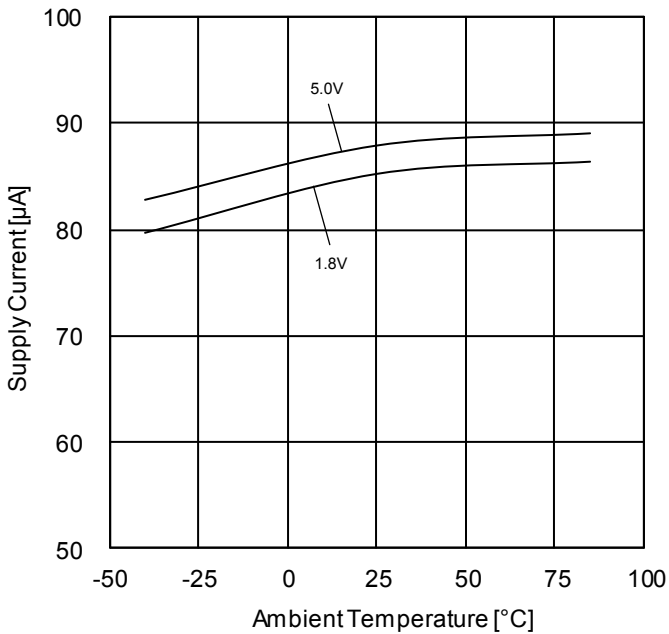

Figure 3. Supply Current vs Ambient Temperature

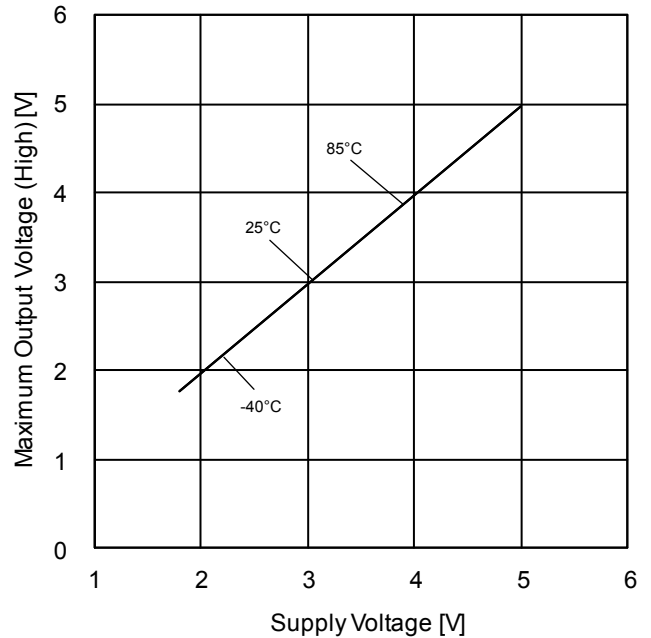

Figure 4. Maximum Output Voltage High vs Supply Voltage (RL=2kΩ)

(\*The data above is measurement value of typical sample, it is not guaranteed.

Typical Performance Curves – continued

OTLR341G

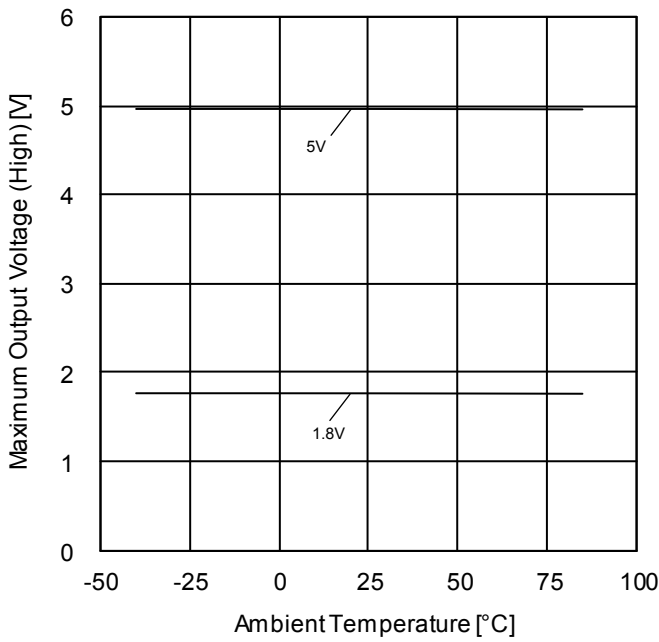

Figure 5. Maximum Output Voltage High vs Ambient Temperature ( $R_L=2k\Omega$ )

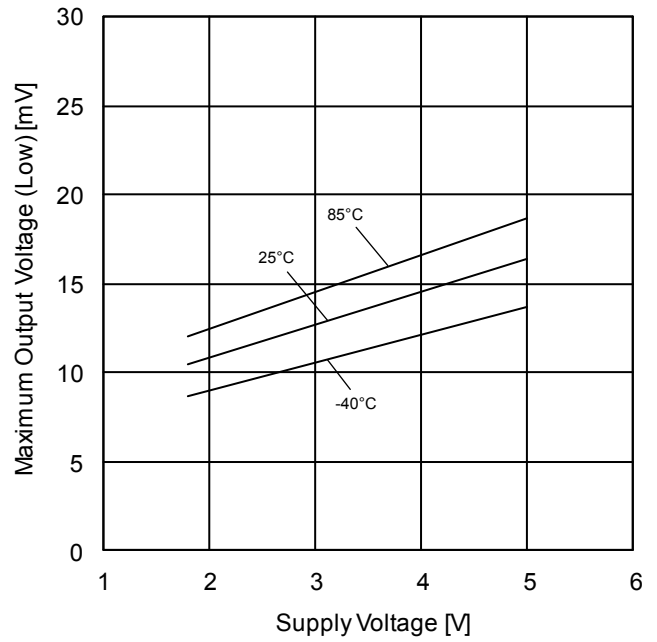

Figure 6. Maximum Output Voltage Low vs Supply Voltage ( $R_L=2k\Omega$ )

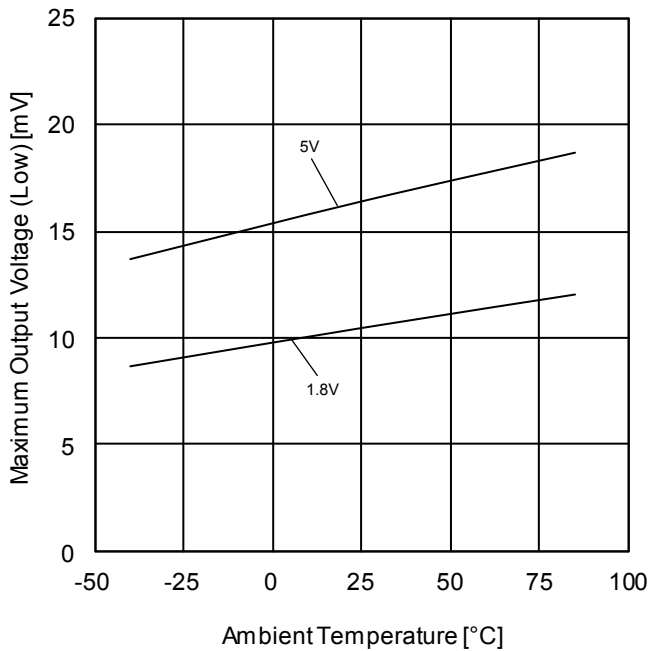

Figure 7. Maximum Output Voltage (Low) vs Ambient Temperature ( $R_L=2k\Omega$ )

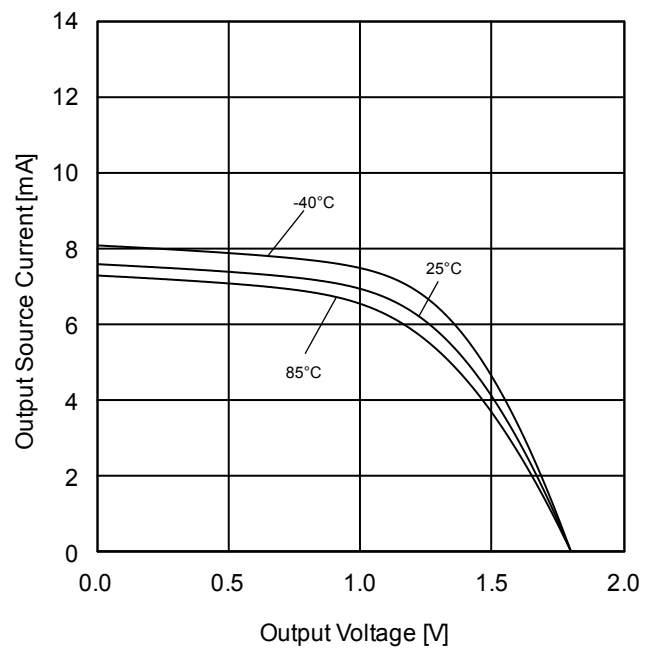

Figure 8. Output Source Current vs Output Voltage ( $V_{DD}=1.8V$ )

(\*The data above is measurement value of typical sample, it is not guaranteed.

Typical Performance Curves – continued

OTLR341G

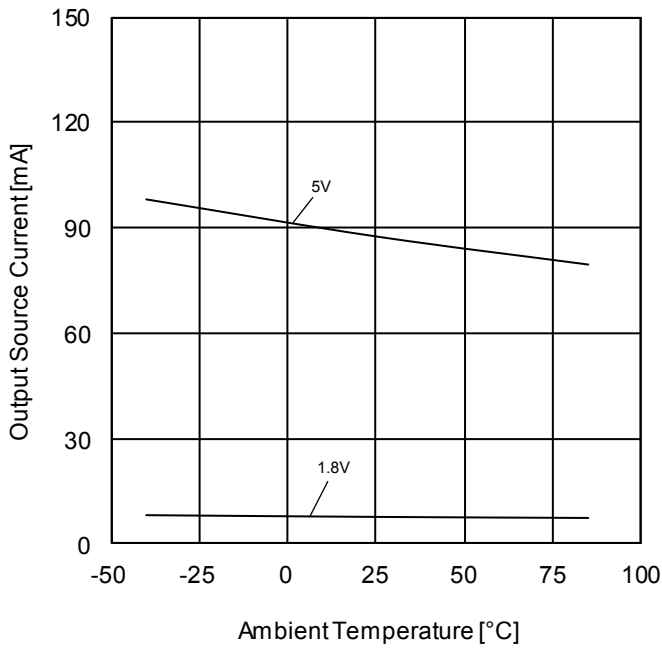

Figure 9. Output Source Current vs Ambient Temperature ( $V_{OUT}=0V$ )

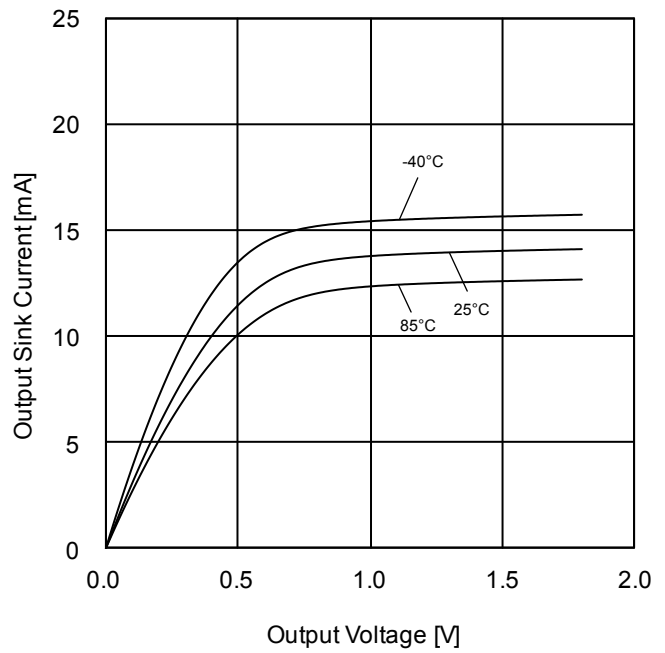

Figure 10. Output Sink Current vs Output Voltage ( $V_{DD}=1.8V$ )

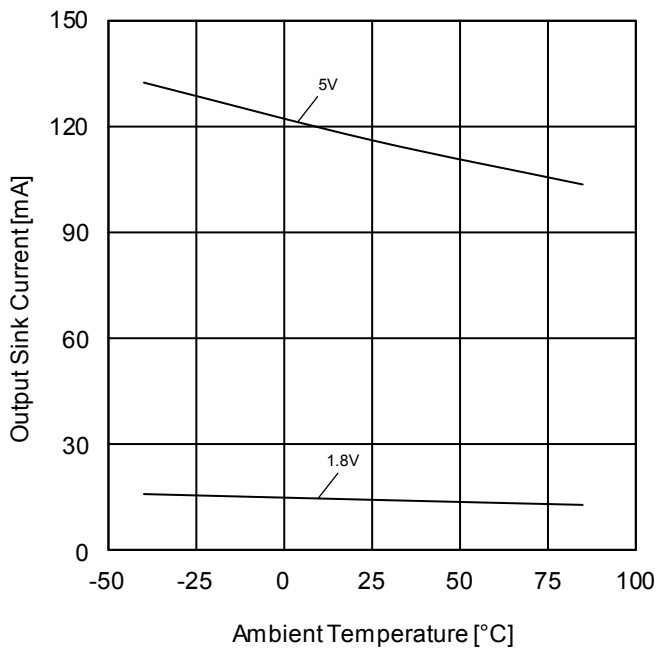

Figure 11. Output Sink Current vs Ambient Temperature ( $V_{OUT}=V_{DD}$ )

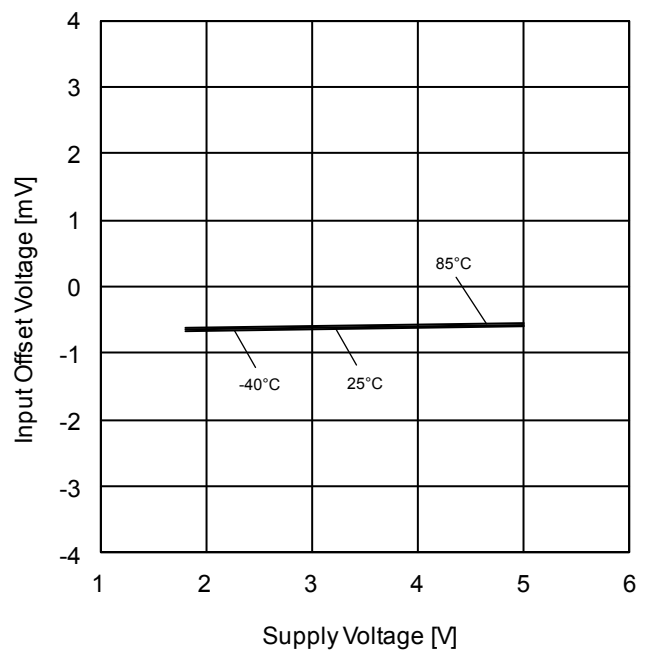

Figure 12. Input Offset Voltage vs Supply Voltage

(\*The data above is measurement value of typical sample, it is not guaranteed.

Typical Performance Curves – continued

OTLR341G

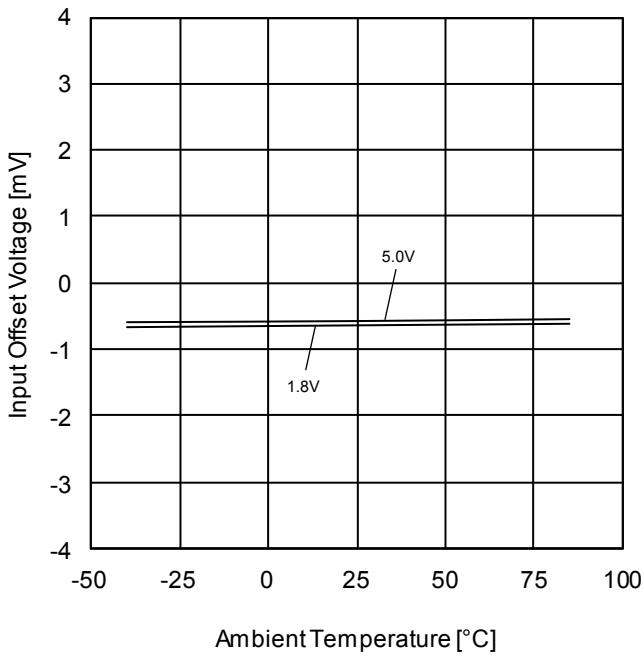

Figure 13. Input Offset Voltage vs Ambient Temperature

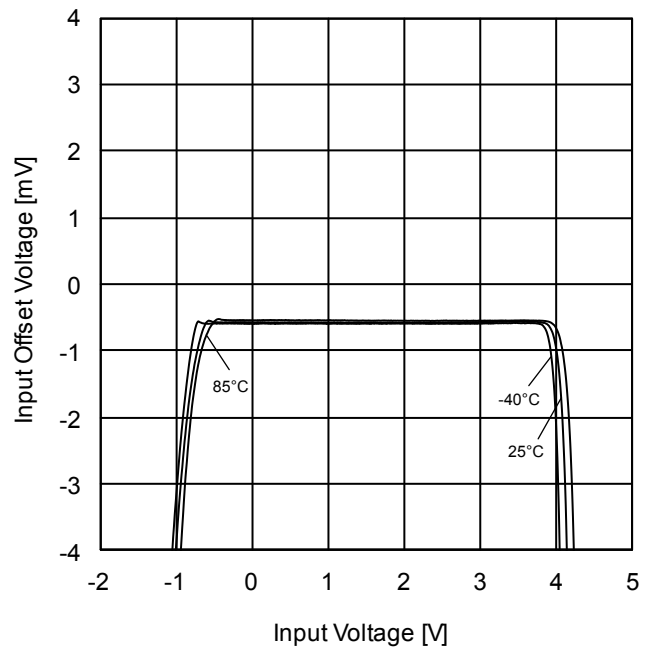

Figure 14. Input Offset Voltage vs Input Voltage ( $V_{DD}=5V$ )

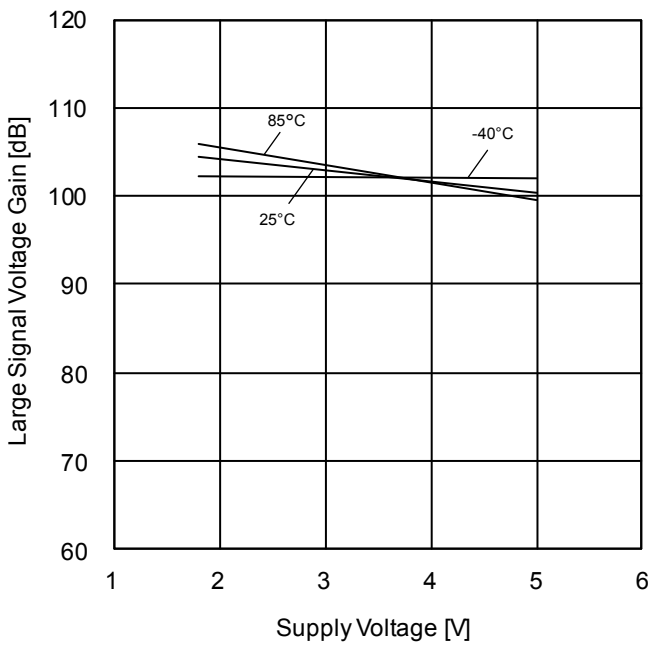

Figure 15. Large Signal Voltage Gain vs Supply Voltage ( $R_L=2k\Omega$ )

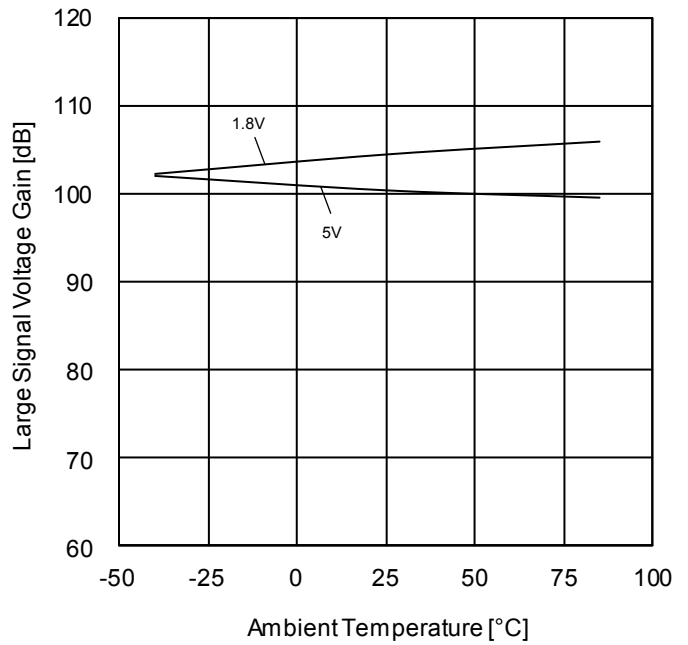

Figure 16. Large Signal Voltage Gain vs Ambient Temperature ( $R_L=2k\Omega$ )

(\*The data above is measurement value of typical sample, it is not guaranteed.

Typical Performance Curves – continued

OTLR341G

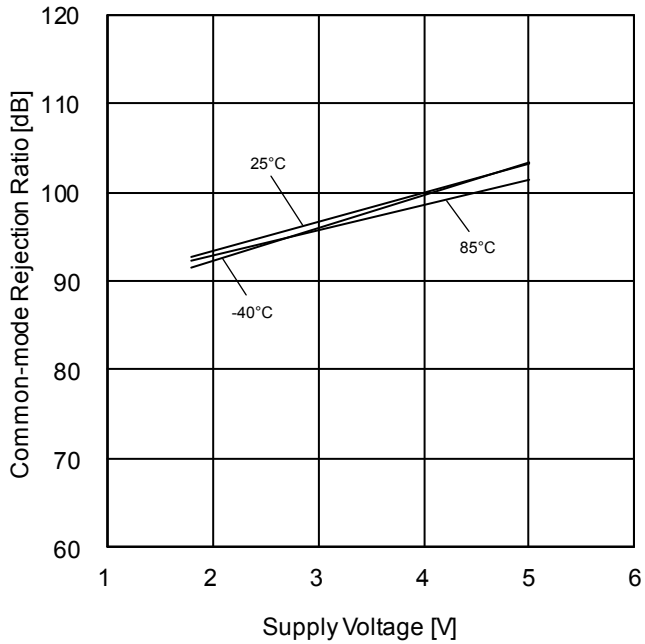

Figure 17. Common-mode Rejection Ratio vs Supply Voltage ( $V_{DD}=1.8V$ )

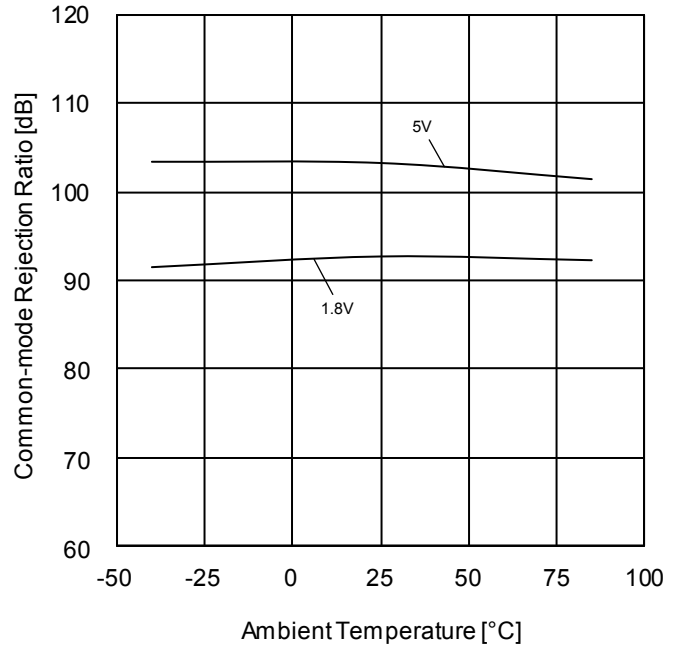

Figure 18. Common-mode Rejection Ratio vs Ambient Temperature

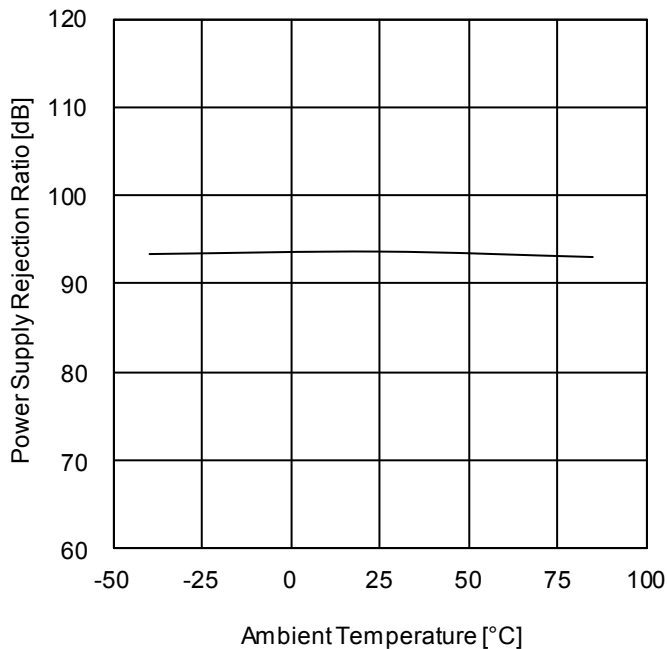

Figure 19. Power Supply Rejection Ratio vs Ambient Temperature ( $V_{DD}=1.8V$  to  $5.0V$ )

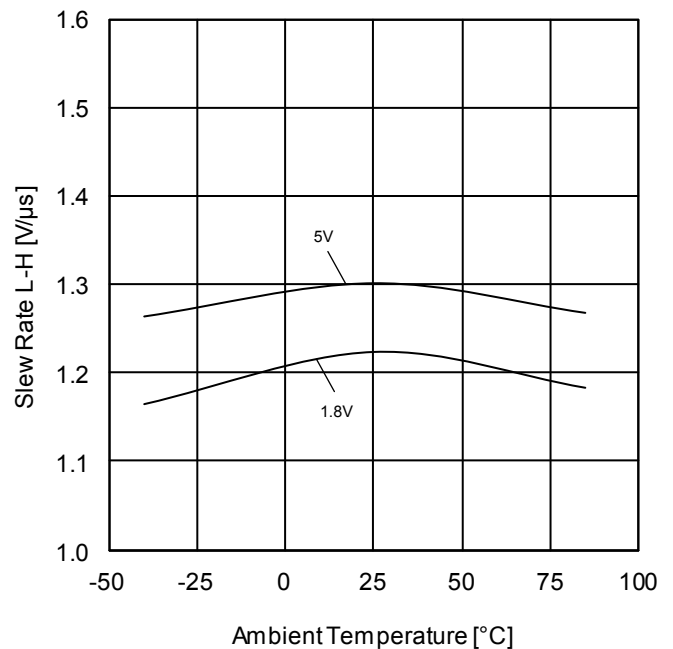

Figure 20. Slew Rate L-H vs Ambient Temperature

(\*The data above is measurement value of typical sample, it is not guaranteed.



Typical Performance Curves – continued

OTLR341G

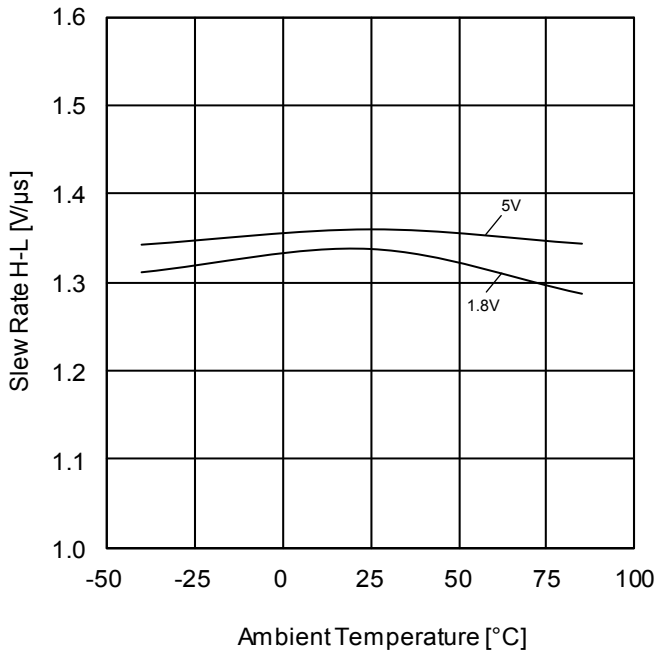

Figure 21. Slew Rate H-L vs Ambient Temperature

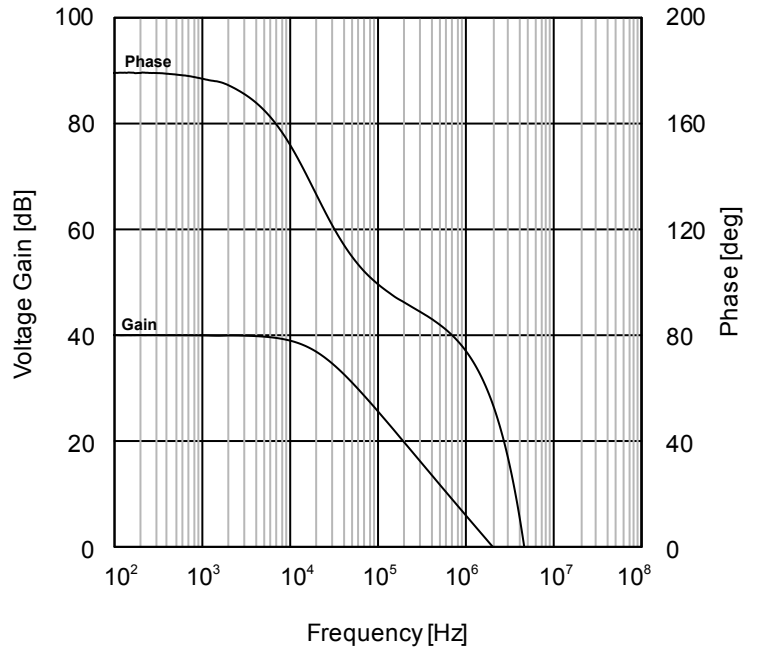

Figure 22. Voltage Gain, Phase vs Frequency (V<sub>DD</sub>=1.8V, T<sub>A</sub>=25°C)

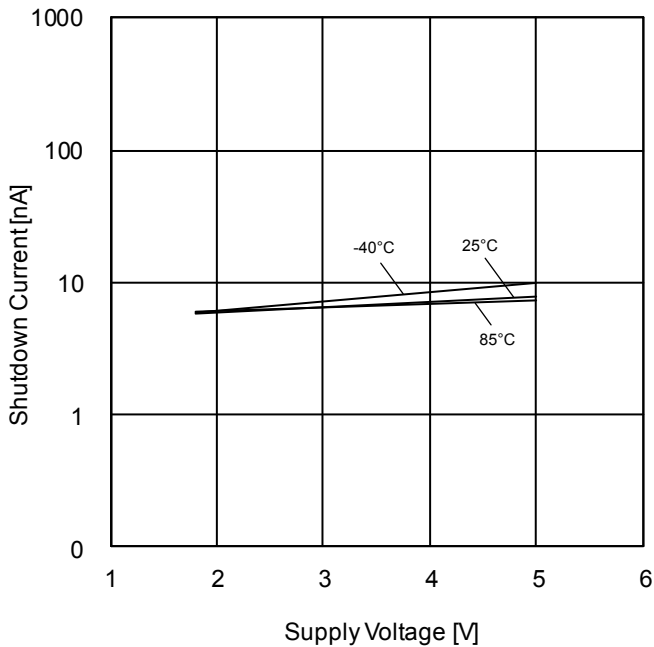

Figure 23. Shutdown Current vs Supply Voltage (V<sub>SHDN</sub>=0V)

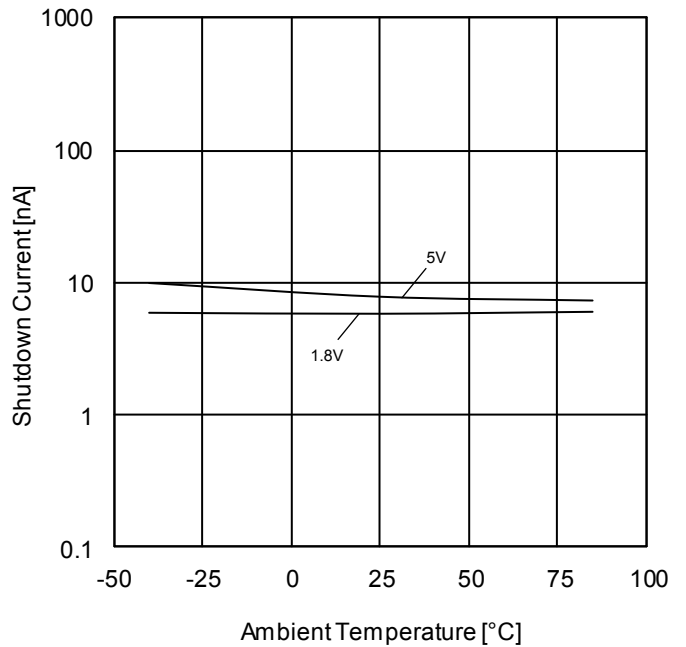

Figure 24. Shutdown Current vs Ambient Temperature (V<sub>SHDN</sub>=0V)

(\*The data above is measurement value of typical sample, it is not guaranteed.

Typical Performance Curves – continued

O TLR341G

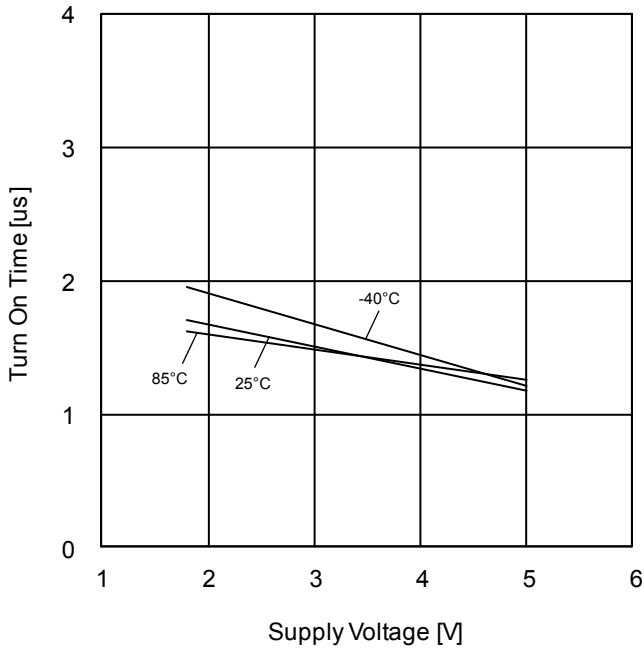

Figure 25. Turn On Time vs Supply Voltage

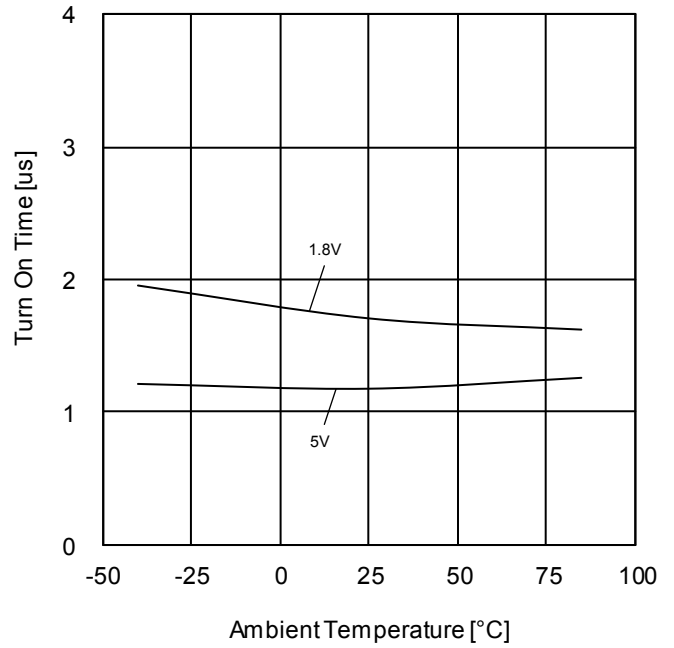

Figure 26. Turn On Time vs Ambient Temperature

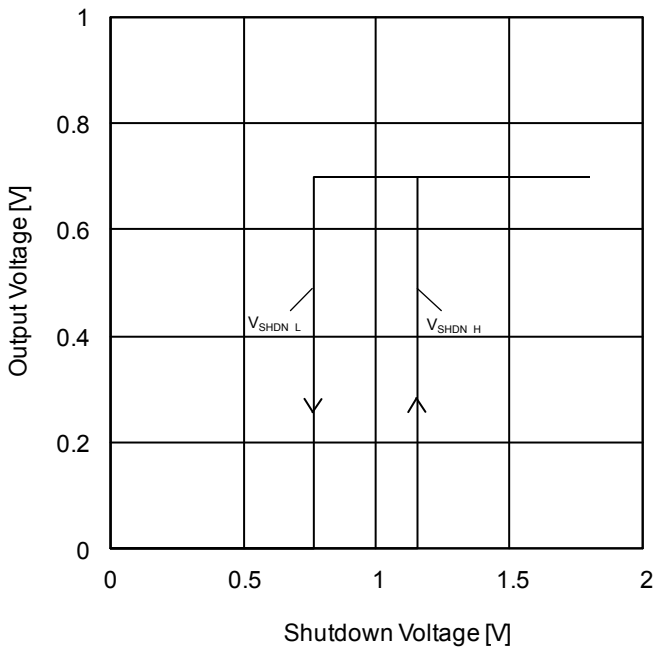

Figure 27. Output Voltage vs Shutdown Voltage  
( $V_{DD}=1.8V$ ,  $A_V=0dB$ ,  $V_{+IN}=0.7V$ ,  $T_A=25^\circ C$ )

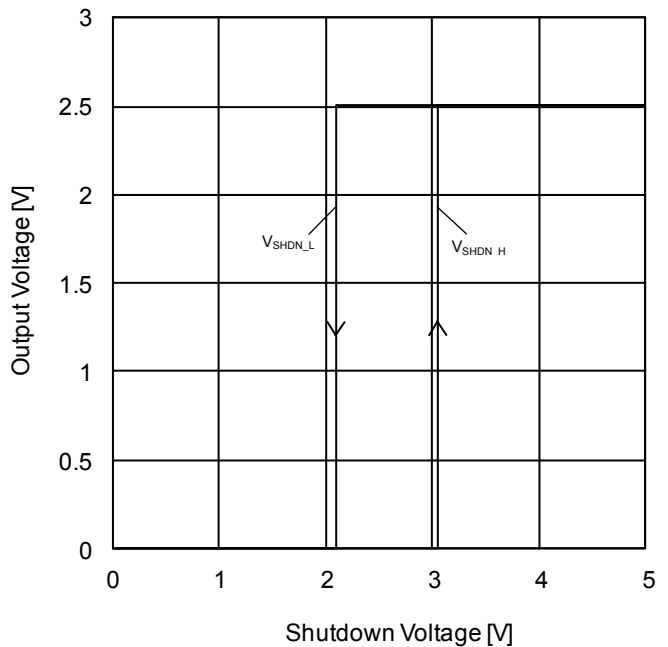

Figure 28. Output Voltage vs Shutdown Voltage  
( $V_{DD}=5V$ ,  $A_V=0dB$ ,  $V_{+IN}=2.5V$ ,  $T_A=25^\circ C$ )

(\*The data above is measurement value of typical sample, it is not guaranteed.

Typical Performance Curves – continued

○TLR342xxx

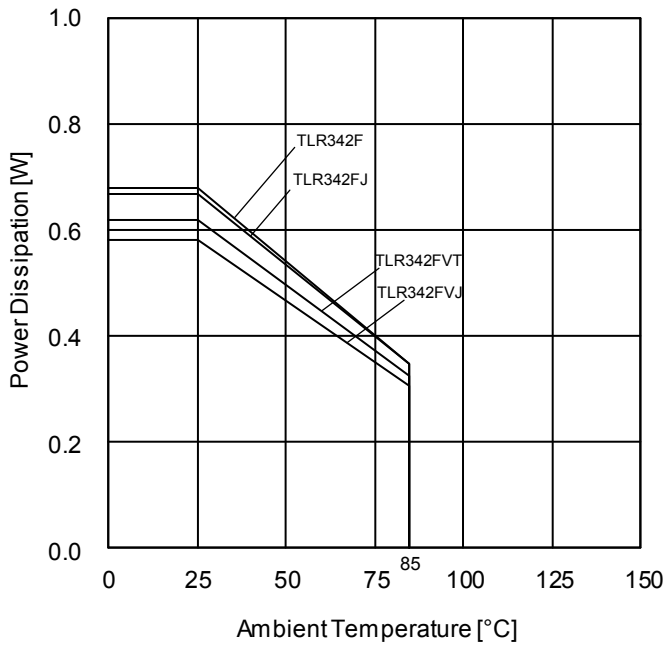

Figure 29. Power Dissipation vs Ambient Temperature (Derating Curve)

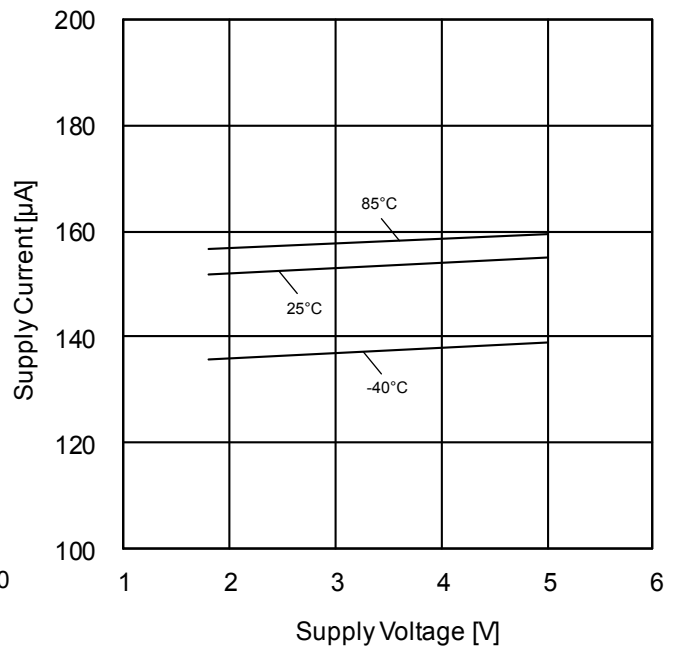

Figure 30. Supply Current vs Supply Voltage

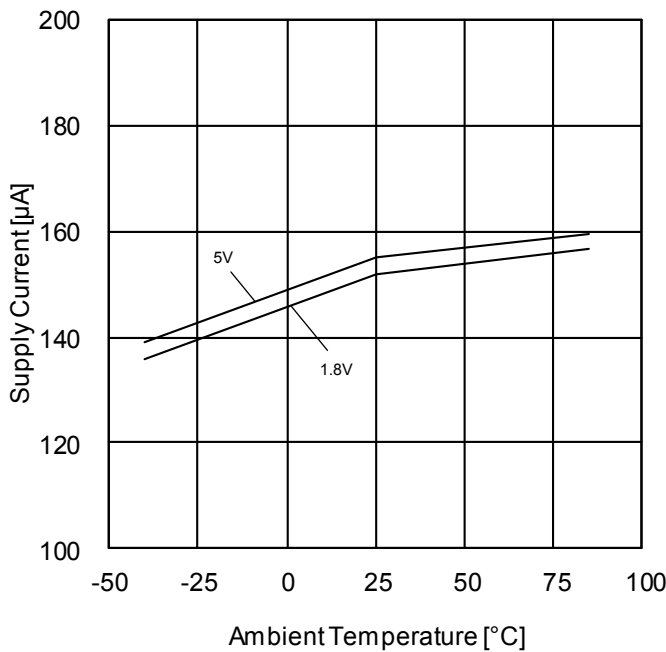

Figure 31. Supply Current vs Ambient Temperature

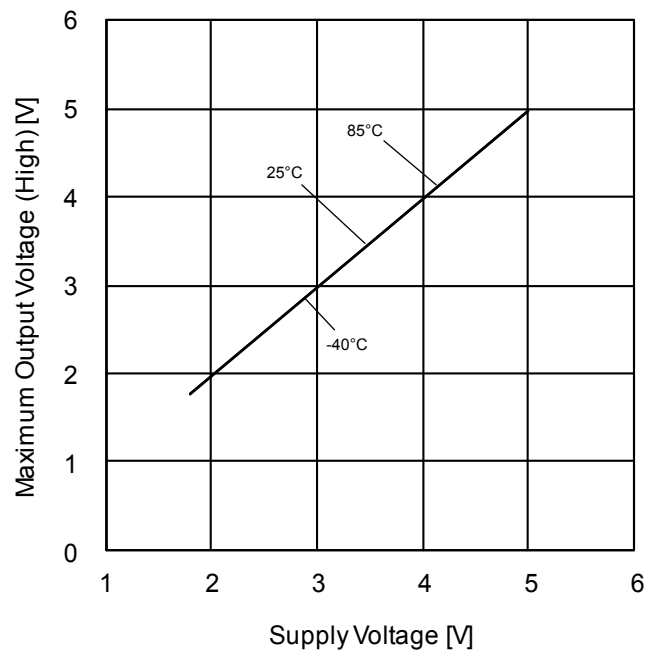

Figure 32. Maximum Output Voltage High vs Supply Voltage ( $R_L=2k\Omega$ )

(\*The data above is measurement value of typical sample, it is not guaranteed.

Typical Performance Curves – continued

OTLR342xxx

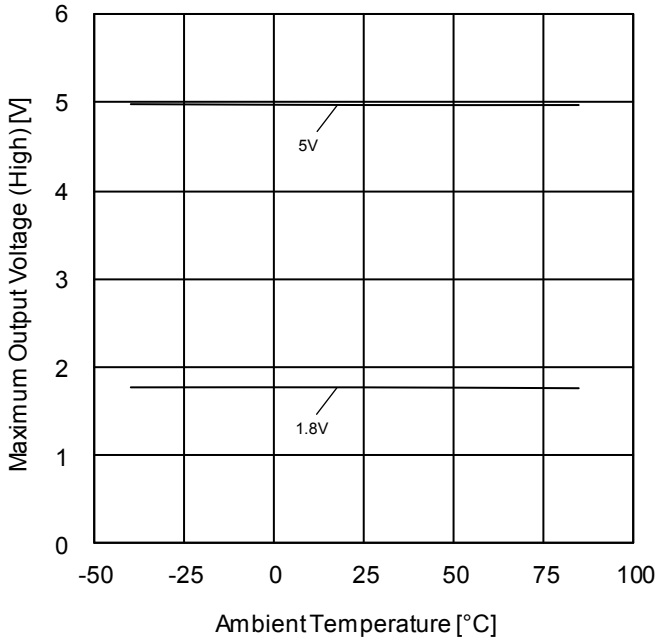

Figure 33. Maximum Output Voltage High vs Ambient Temperature ( $R_L=2k\Omega$ )

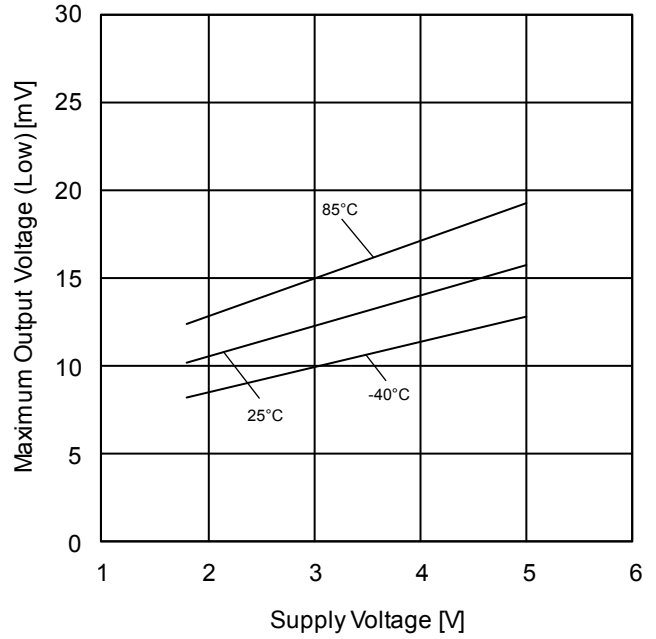

Figure 34. Maximum Output Voltage Low vs Supply Voltage ( $R_L=2k\Omega$ )

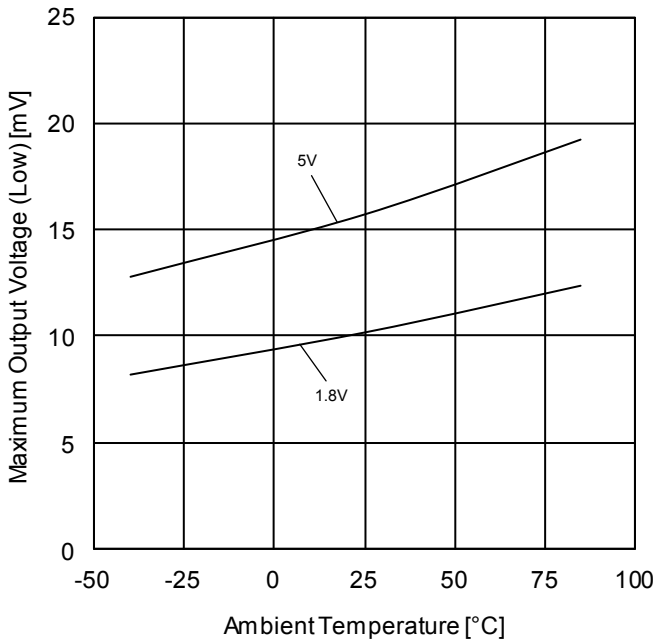

Figure 35. Maximum Output Voltage (Low) vs Ambient Temperature ( $R_L=2k\Omega$ )

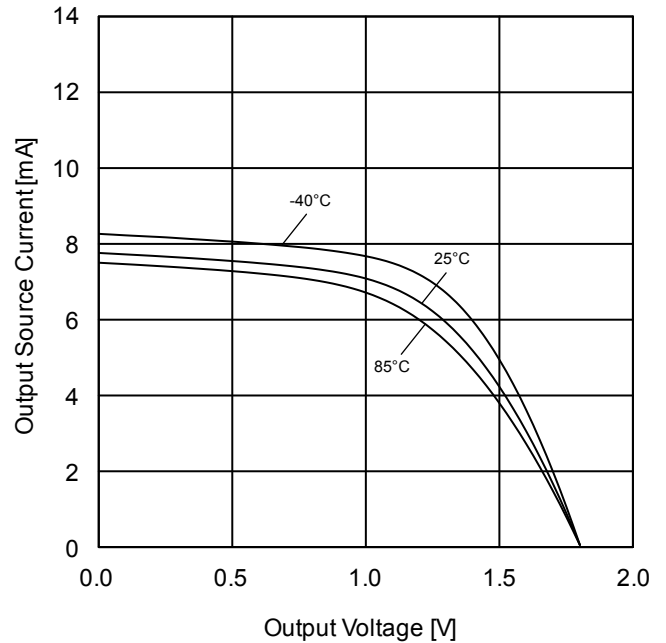

Figure 36. Output Source Current vs Output Voltage ( $V_{DD}=1.8V$ )

(\*The data above is measurement value of typical sample, it is not guaranteed.

Typical Performance Curves – continued

OTLR342xxx

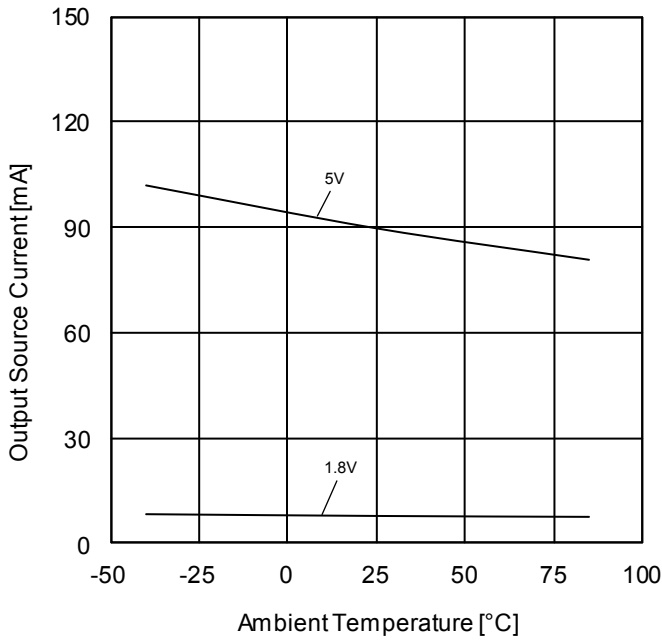

Figure 37. Output Source Current vs Ambient Temperature ( $V_{OUT}=0V$ )

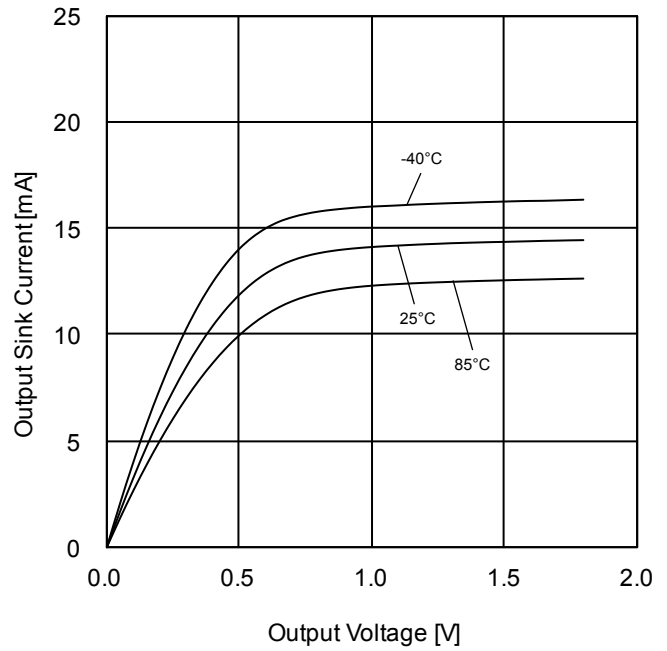

Figure 38. Output Sink Current vs Output Voltage ( $V_{DD}=1.8V$ )

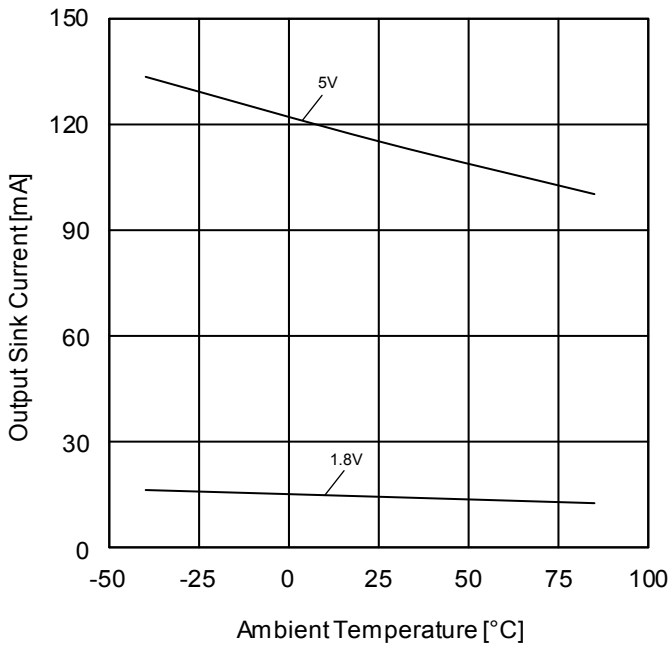

Figure 39. Output Sink Current vs Ambient Temperature ( $V_{OUT}=V_{DD}$ )

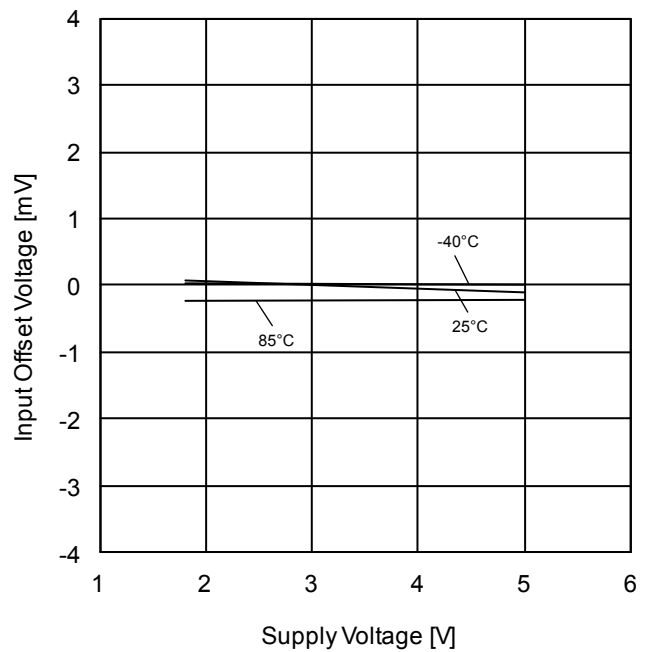

Figure 40. Input Offset Voltage vs Supply Voltage

(\*The data above is measurement value of typical sample, it is not guaranteed.

Typical Performance Curves – continued

OTLR342xxx

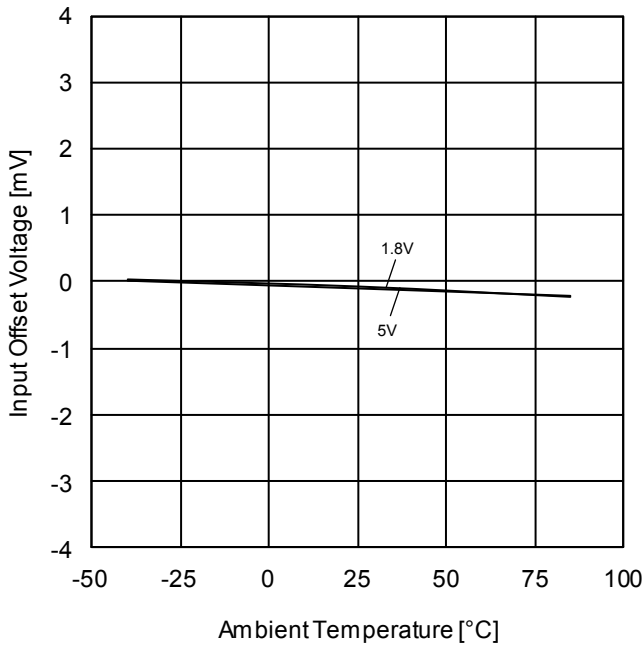

Figure 41. Input Offset Voltage vs Ambient Temperature

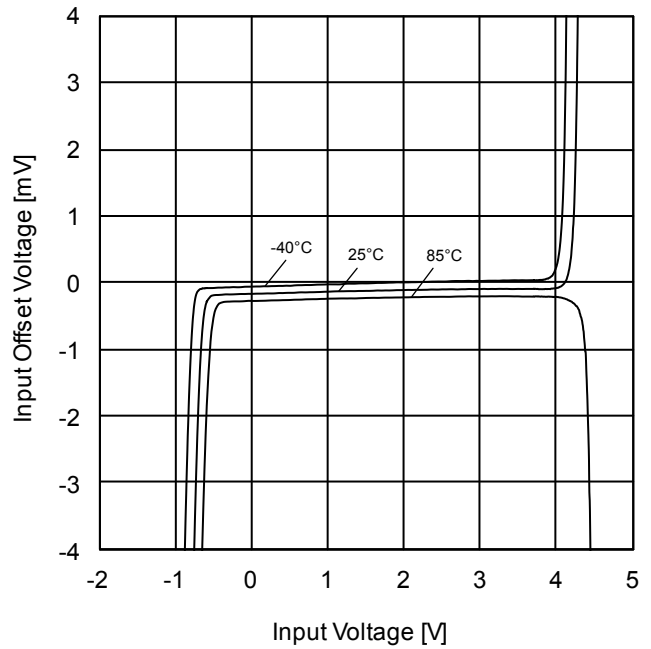

Figure 42. Input Offset Voltage vs Input Voltage (V<sub>DD</sub>=5V)

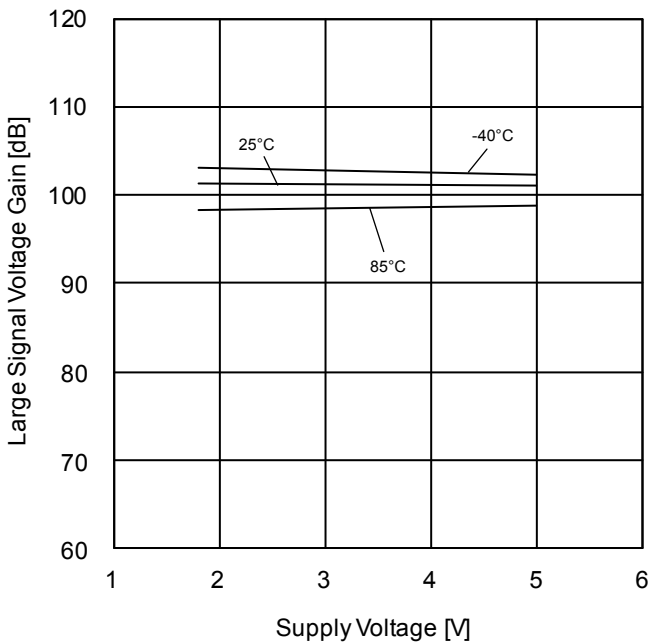

Figure 43. Large Signal Voltage Gain vs Supply Voltage (R<sub>L</sub>=2kΩ)

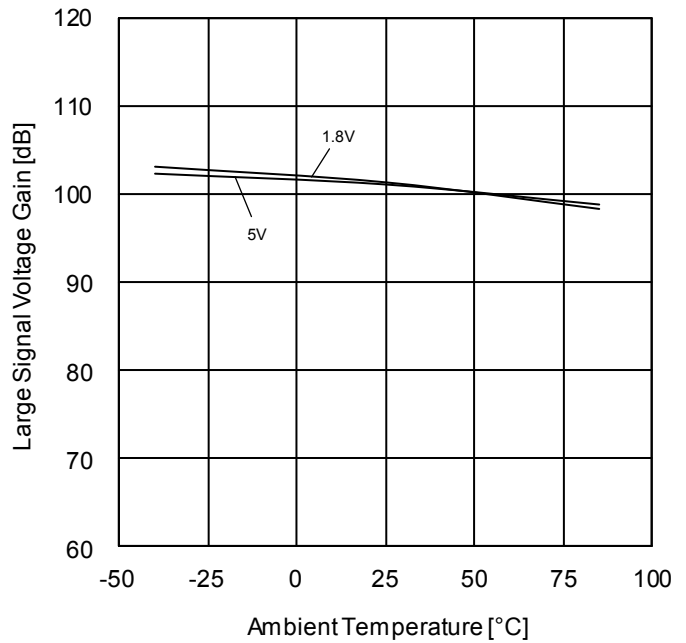

Figure 44. Large Signal Voltage Gain vs Ambient Temperature (R<sub>L</sub>=2kΩ)

(\*The data above is measurement value of typical sample, it is not guaranteed.

Typical Performance Curves – continued

○TLR342xxx

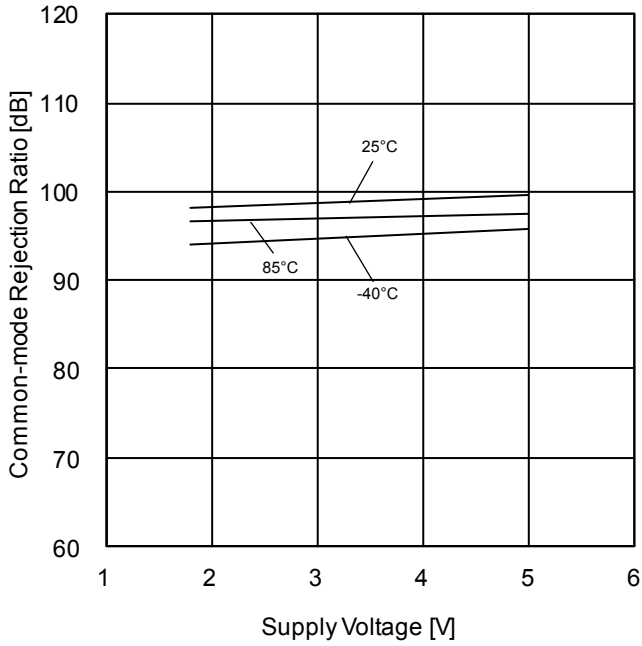

Figure 45. Common-mode Rejection Ratio vs Supply Voltage ( $V_{DD}=1.8V$ )

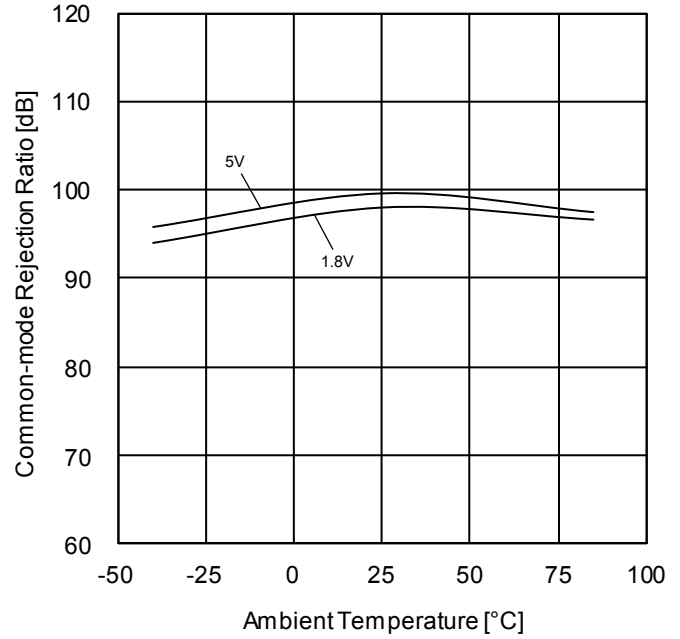

Figure 46. Common-mode Rejection Ratio vs Ambient Temperature

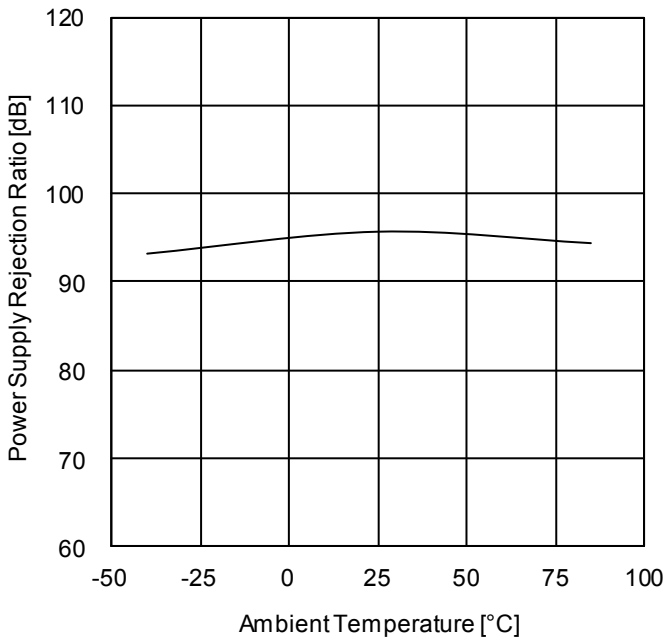

Figure 47. Power Supply Rejection Ratio vs Ambient Temperature ( $V_{DD}=1.8V$  to  $5.0V$ )

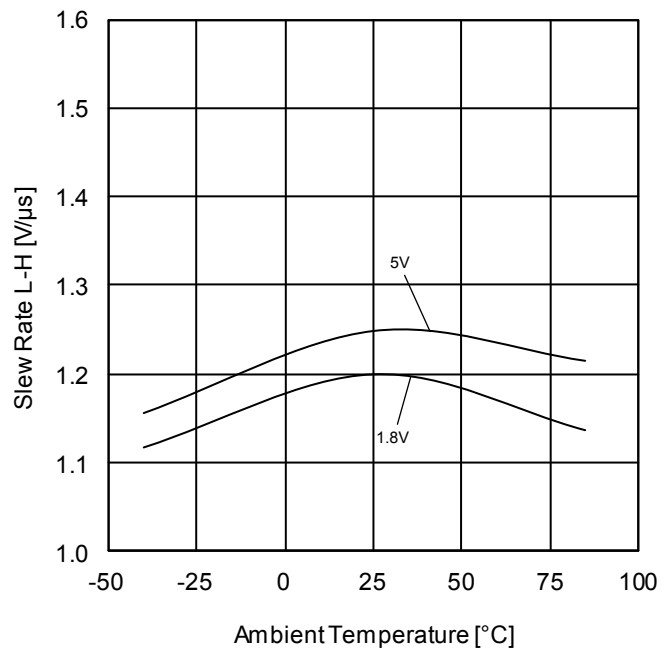

Figure 48. Slew Rate L-H vs Ambient Temperature

(\*The data above is measurement value of typical sample, it is not guaranteed.

Typical Performance Curves – continued

OTLR342xxx

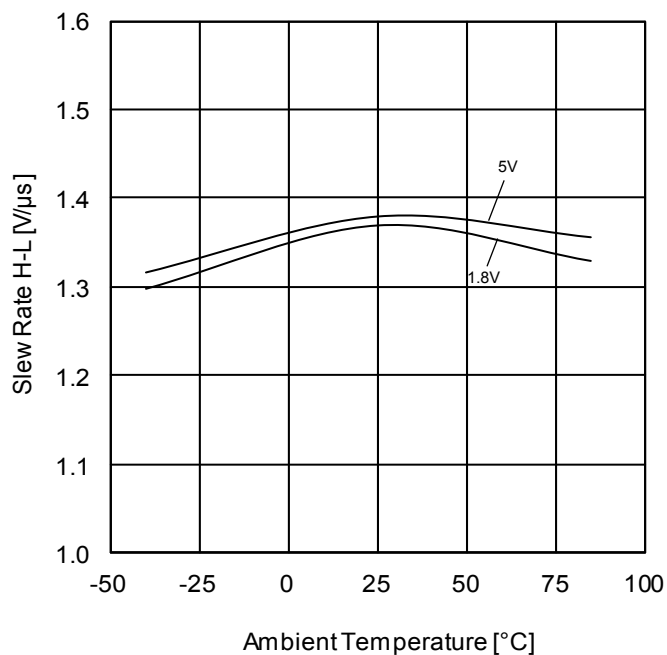

Figure 49. Slew Rate H-L vs Ambient Temperature

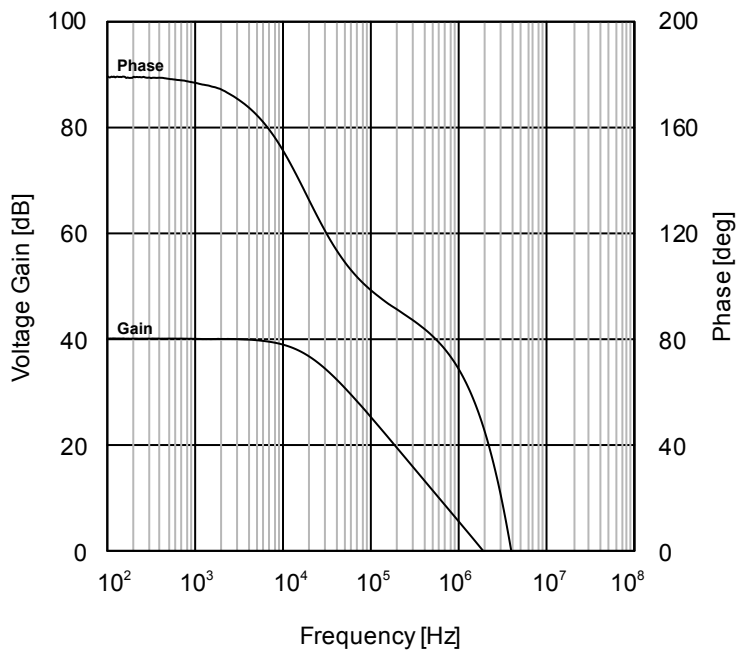

Figure 50. Voltage Gain, Phase vs Frequency (V<sub>DD</sub>=1.8V, T<sub>A</sub>=25°C)

(\*The data above is measurement value of typical sample, it is not guaranteed.



Typical Performance Curves – continued

OTLR344xxx

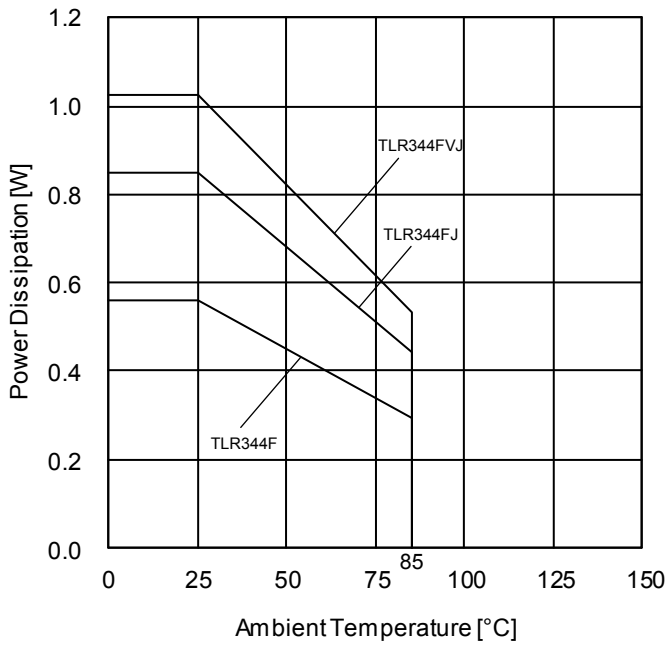

Figure 51. Power Dissipation vs Ambient Temperature (Derating Curve)

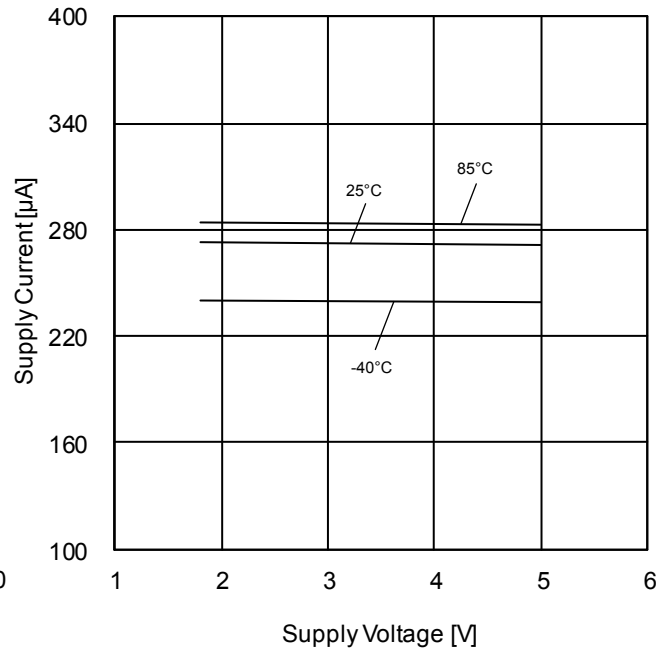

Figure 52. Supply Current vs Supply Voltage

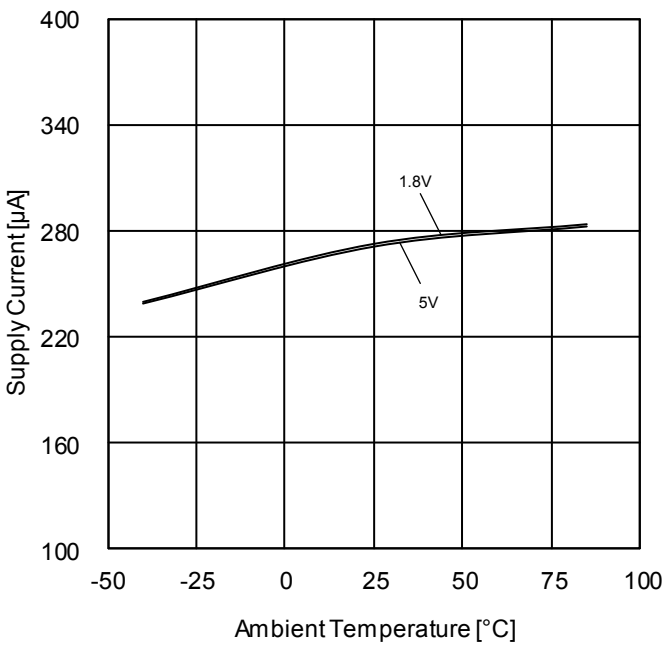

Figure 53. Supply Current vs Ambient Temperature

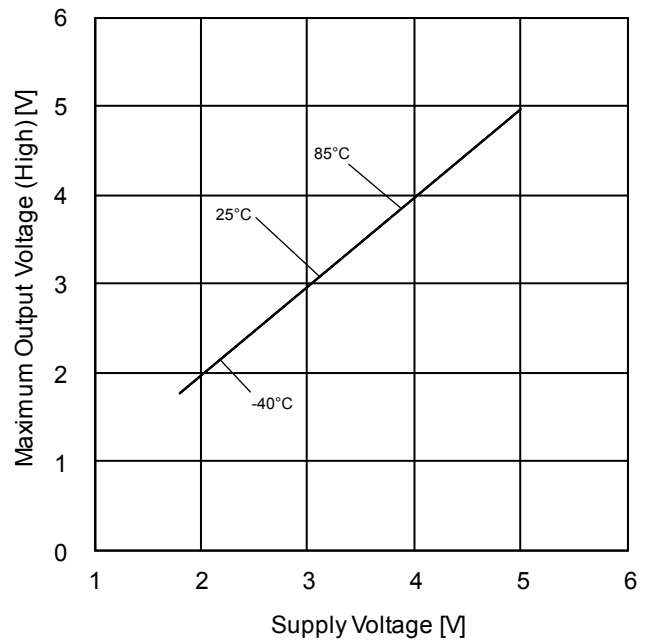

Figure 54. Maximum Output Voltage High vs Supply Voltage (RL=2kΩ)

(\*The data above is measurement value of typical sample, it is not guaranteed.

Typical Performance Curves – continued

OTLR344xxx

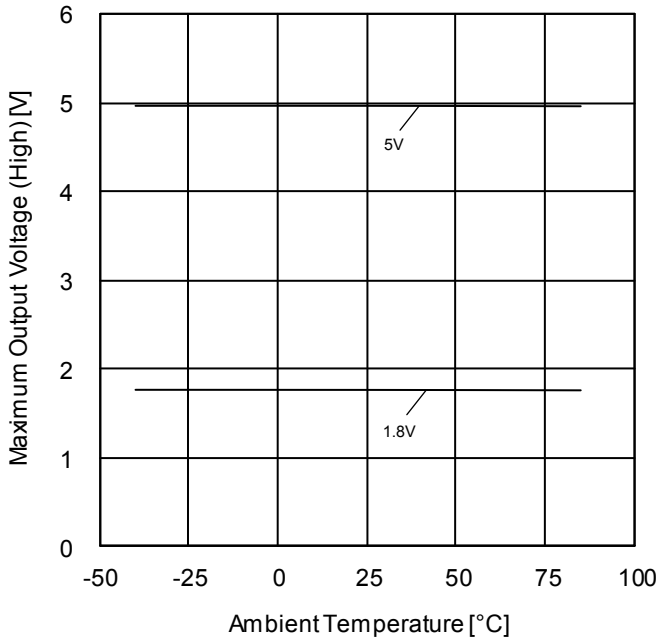

Figure 55. Maximum Output Voltage High vs Ambient Temperature ( $R_L=2k\Omega$ )

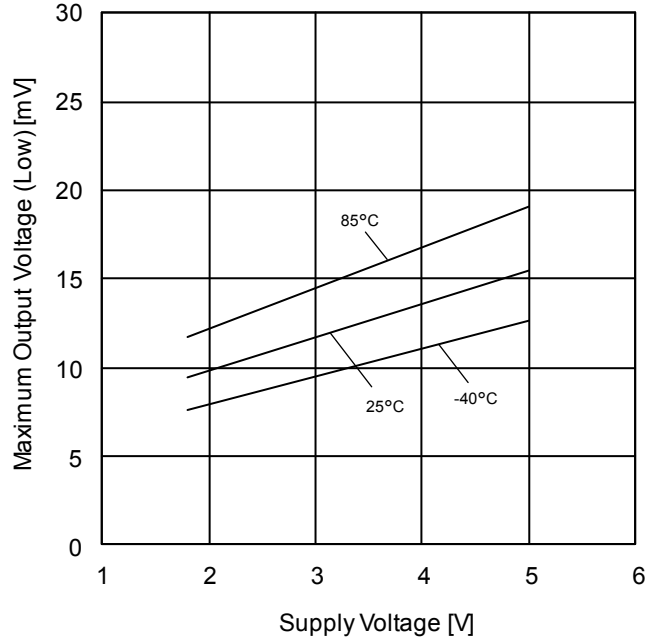

Figure 56. Maximum Output Voltage Low vs Supply Voltage ( $R_L=2k\Omega$ )

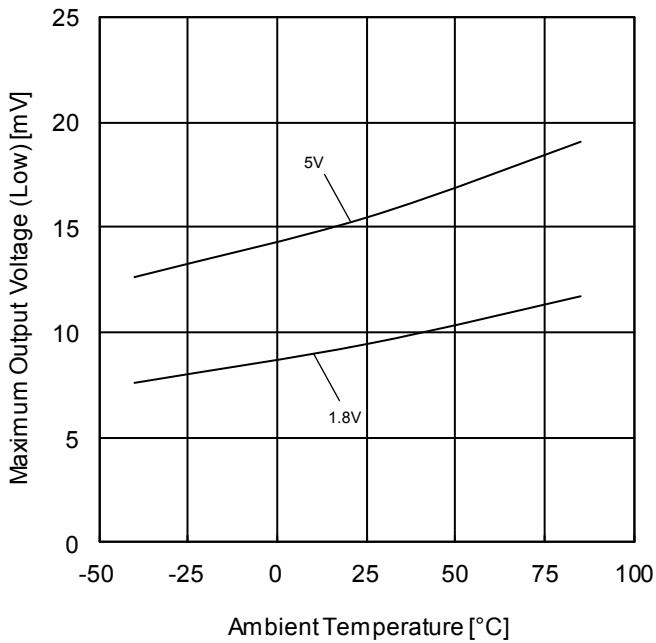

Figure 57. Maximum Output Voltage (Low) vs Ambient Temperature ( $R_L=2k\Omega$ )

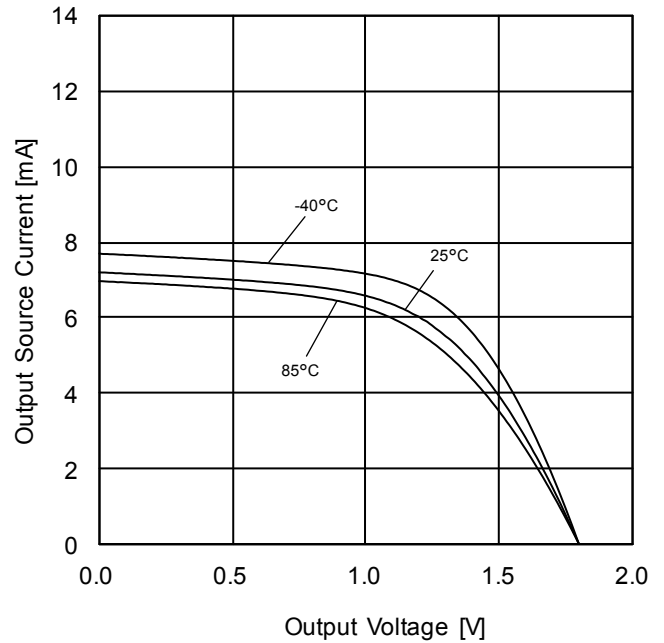

Figure 58. Output Source Current vs Output Voltage ( $V_{DD}=1.8V$ )

(\*The data above is measurement value of typical sample, it is not guaranteed.

Typical Performance Curves – continued

○TLR344xxx

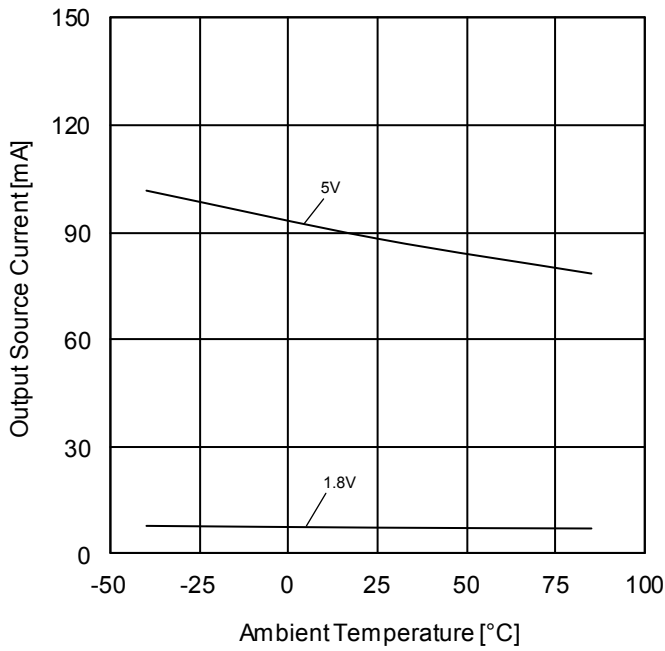

Figure 59. Output Source Current vs Ambient Temperature ( $V_{OUT}=0V$ )

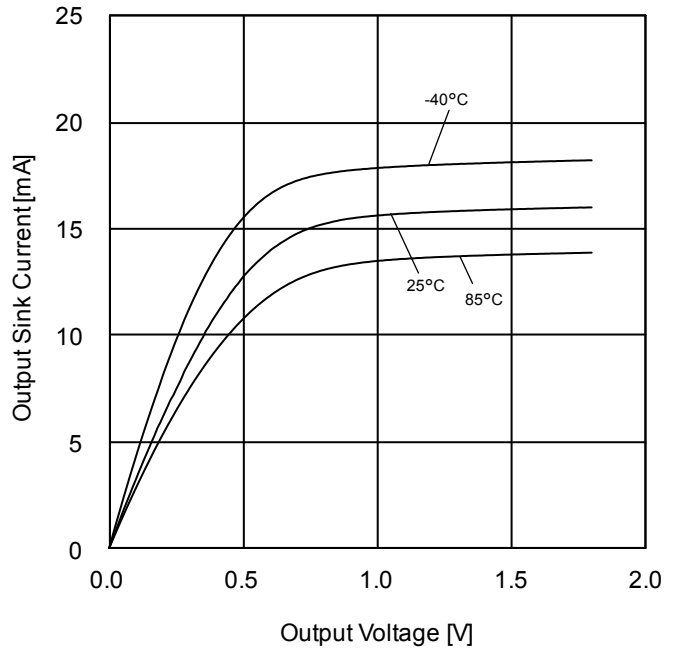

Figure 60. Output Sink Current vs Output Voltage ( $V_{DD}=1.8V$ )

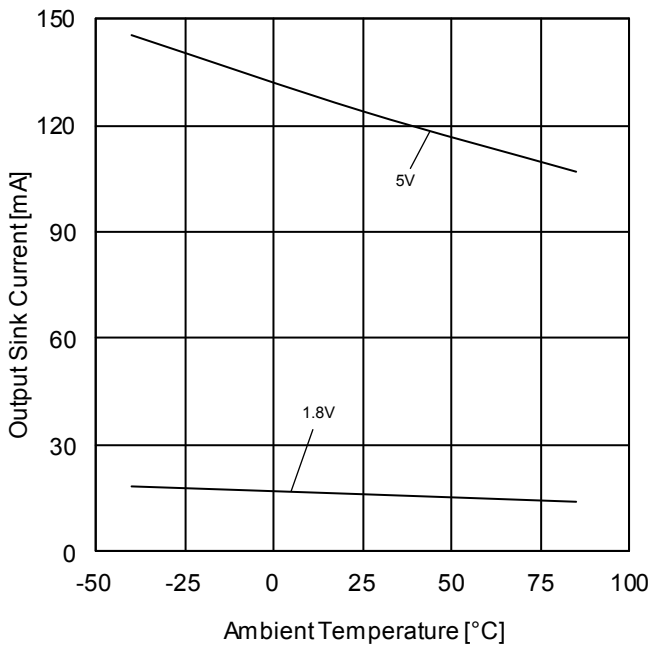

Figure 61. Output Sink Current vs Ambient Temperature ( $V_{OUT}=V_{DD}$ )

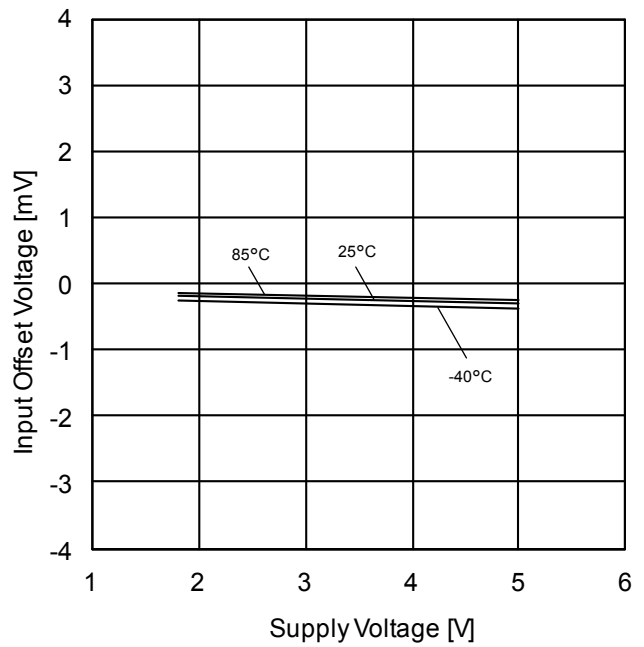

Figure 62. Input Offset Voltage vs Supply Voltage

(\*The data above is measurement value of typical sample, it is not guaranteed.

Typical Performance Curves – continued

○TLR344xxx

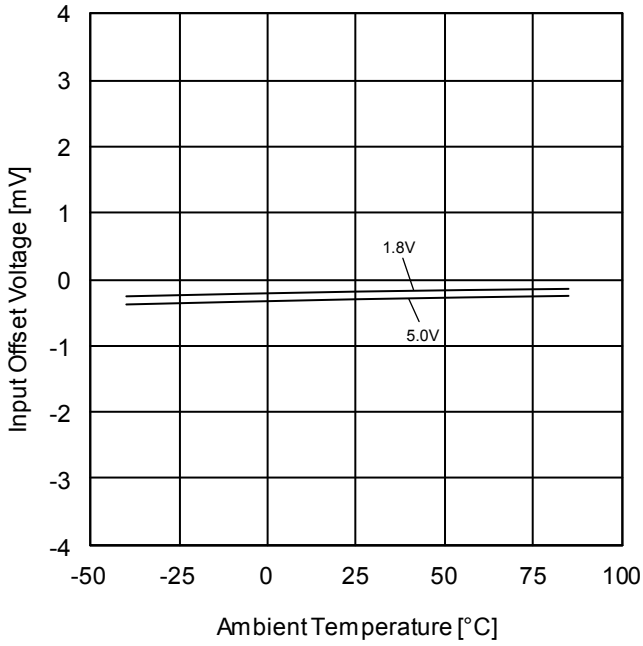

Figure 63. Input Offset Voltage vs Ambient Temperature

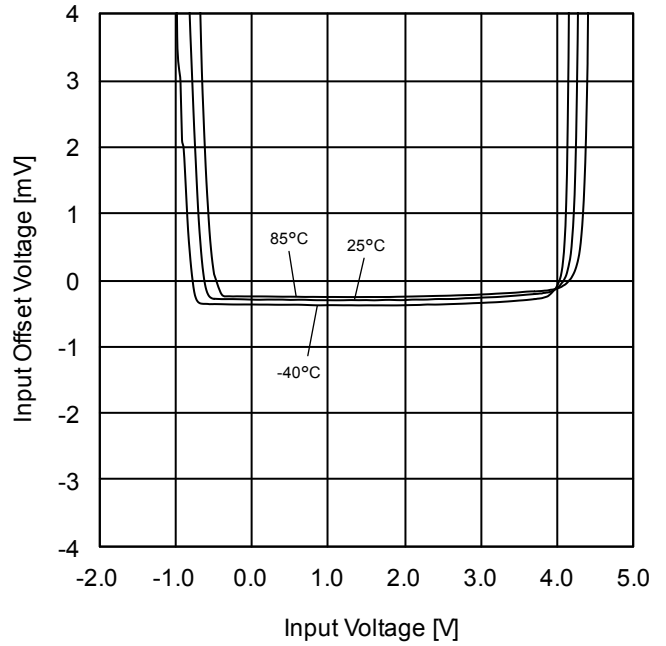

Figure 64. Input Offset Voltage vs Input Voltage (V<sub>DD</sub>=5V)

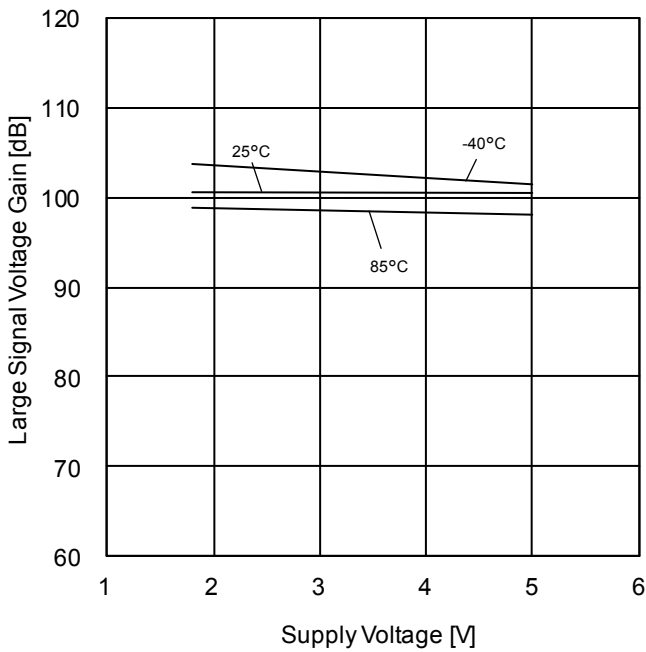

Figure 65. Large Signal Voltage Gain vs Supply Voltage (R<sub>L</sub>=2kΩ)

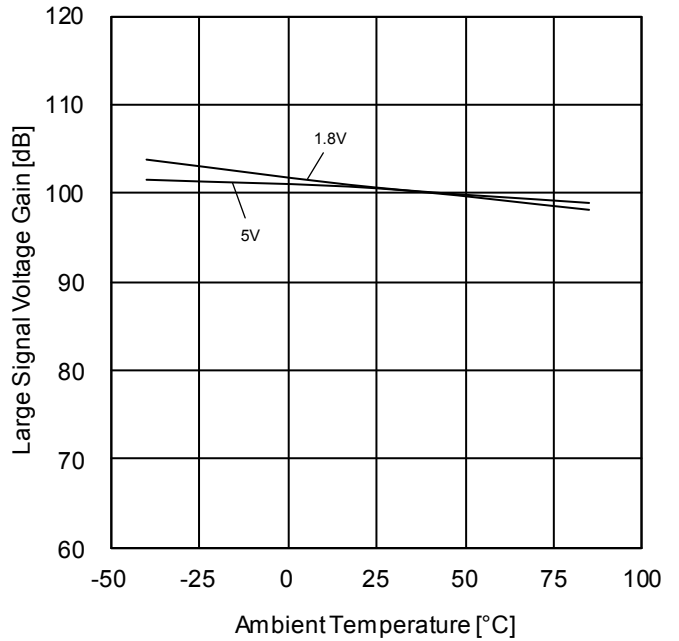

Figure 66. Large Signal Voltage Gain vs Ambient Temperature (R<sub>L</sub>=2kΩ)

(\*The data above is measurement value of typical sample, it is not guaranteed.

Typical Performance Curves – continued

○TLR344xxx

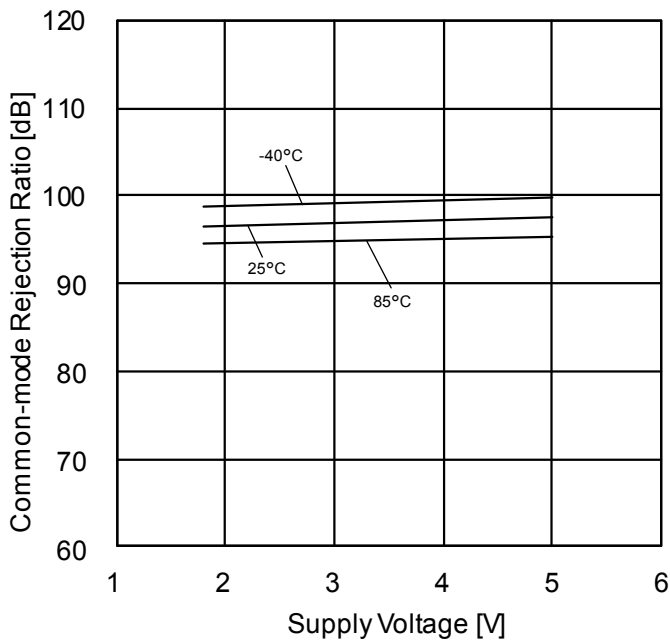

Figure 67. Common-mode Rejection Ratio vs Supply Voltage

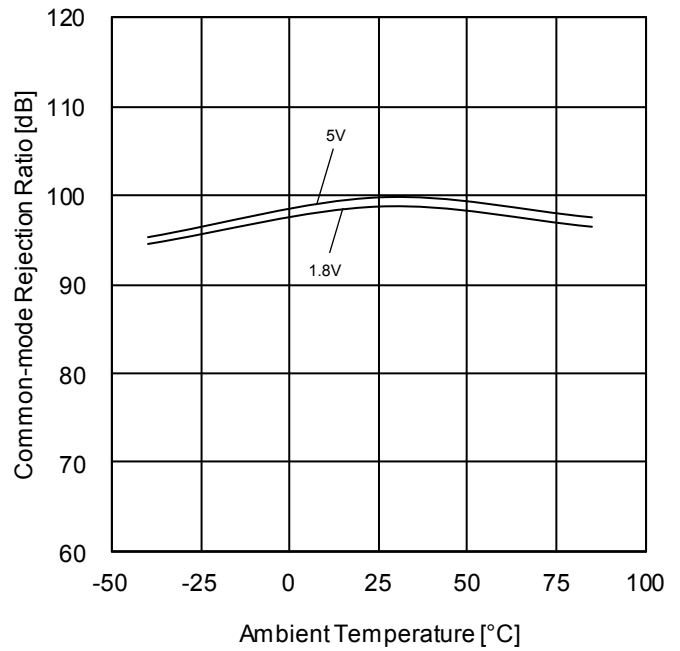

Figure 68. Common-mode Rejection Ratio vs Ambient Temperature

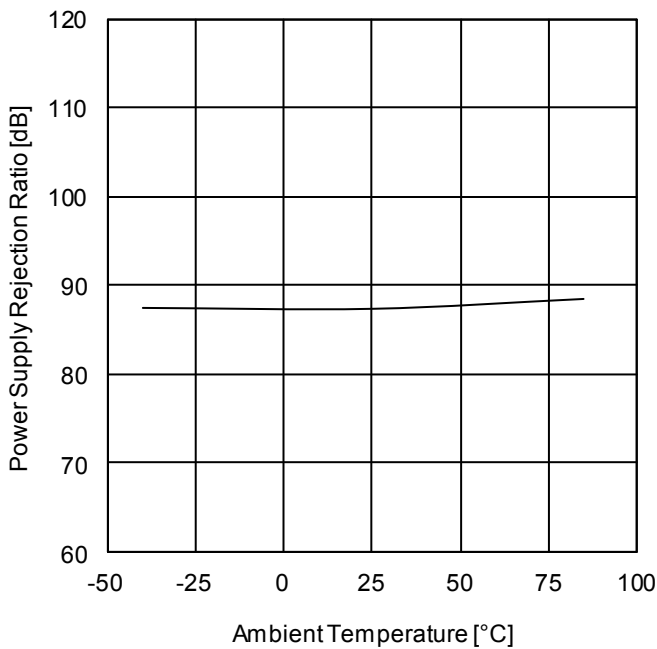

Figure 69. Power Supply Rejection Ratio vs Ambient Temperature ( $V_{DD}=1.8V$  to  $5.0V$ )

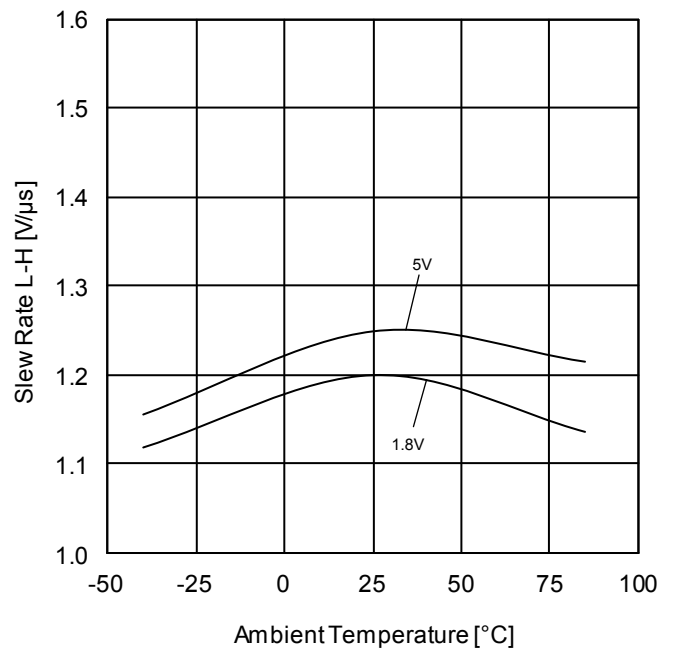

Figure 70. Slew Rate L-H vs Ambient Temperature

(\*The data above is measurement value of typical sample, it is not guaranteed.

Typical Performance Curves – continued

OTLR344xxx

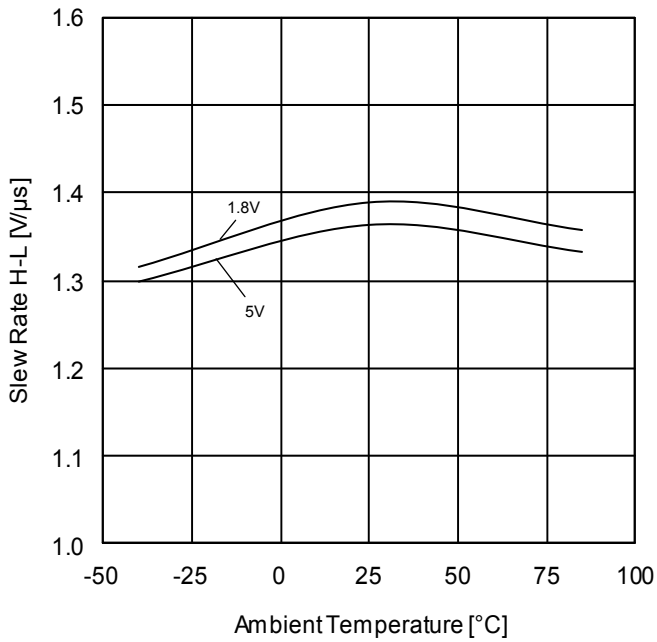

Figure 71. Slew Rate H-L vs Ambient Temperature

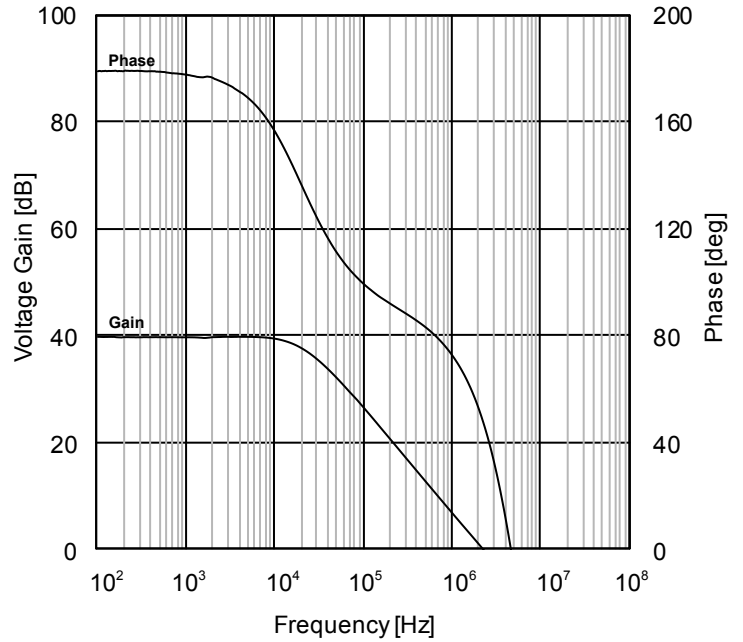

Figure 72. Voltage Gain, Phase vs Frequency (V<sub>DD</sub>=1.8V, T<sub>A</sub>=25°C)

(\*The data above is measurement value of typical sample, it is not guaranteed.

**Application Information**  
**NULL method condition for Test Circuit 1**

$V_{DD}, V_{SS}, E_K, V_{ICM}$  Unit:V

Parameter	$V_F$	SW1	SW2	SW3	$V_{DD}$	$V_{SS}$	$E_K$	$V_{ICM}$	Calculation
Input Offset Voltage	$V_{F1}$	ON	ON	OFF	5	0	-2.5	2.5	1
Large Signal Voltage Gain	$V_{F2}$	ON	ON	ON	5	0	-0.5	2.5	2
	$V_{F3}$						-3.5		
Common-mode Rejection Ratio (Input Common-mode Voltage Range)	$V_{F4}$	ON	ON	OFF	5	0	-2.5	0	3
	$V_{F5}$						-2.5	3	
Power Supply Rejection Ratio	$V_{F6}$	ON	ON	OFF	1.8	0	-0.9	0.5	4
	$V_{F7}$				5				

— Calculation—

- Input Offset Voltage ( $V_{IO}$ ) 
$$V_{IO} = \frac{|V_{F1}|}{1 + R_F/R_S} \quad [V]$$
- Large Signal Voltage Gain ( $A_V$ ) 
$$A_V = 20\text{Log} \frac{\Delta E_K \times (1 + R_F/R_S)}{|V_{F2} - V_{F3}|} \quad [\text{dB}]$$
- Common-mode Rejection Ratio (CMRR) 
$$\text{CMRR} = 20\text{Log} \frac{\Delta V_{ICM} \times (1 + R_F/R_S)}{|V_{F4} - V_{F5}|} \quad [\text{dB}]$$
- Power Supply Rejection Ratio (PSRR) 
$$\text{PSRR} = 20\text{Log} \frac{\Delta V_{DD} \times (1 + R_F/R_S)}{|V_{F6} - V_{F7}|} \quad [\text{dB}]$$

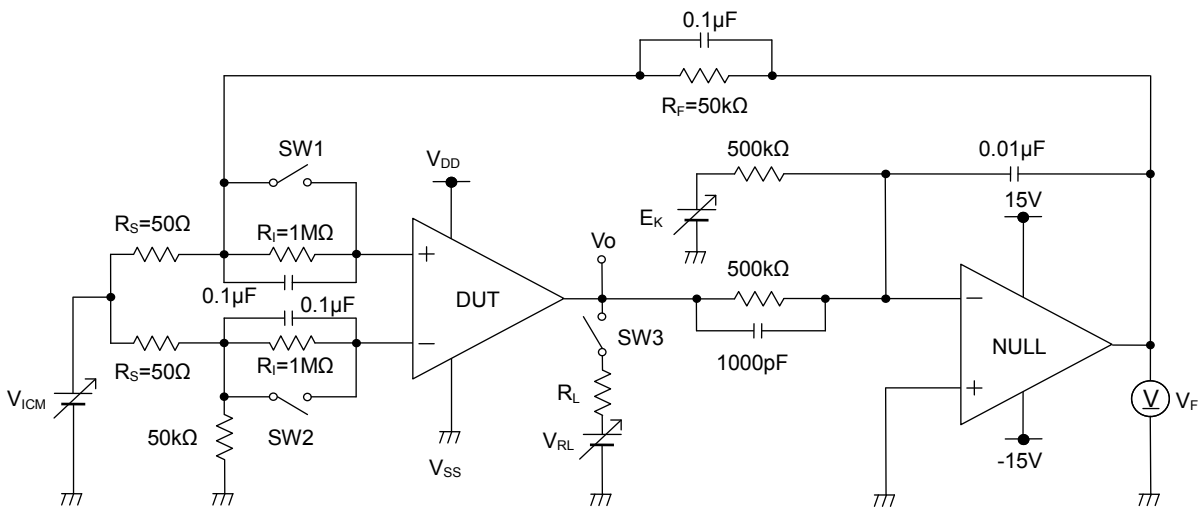

Figure 73. Test Circuit 1

Application Information – continued  
Switch Condition for Test Circuit 2

SW No.	SW1	SW2	SW3	SW4	SW5	SW6	SW7	SW8	SW9	SW10	SW11	SW12
Supply Current	OFF	OFF	ON	OFF	ON	OFF	OFF	OFF	OFF	OFF	OFF	OFF
Maximum Output Voltage $R_L=10k\Omega$	OFF	ON	OFF	OFF	ON	OFF	OFF	ON	OFF	OFF	ON	OFF
Output Current	OFF	ON	OFF	OFF	ON	OFF	OFF	OFF	OFF	ON	OFF	OFF
Slew Rate	OFF	OFF	ON	OFF	OFF	OFF	ON	ON	OFF	OFF	OFF	ON
Unity Gain Frequency	ON	OFF	OFF	ON	ON	OFF	OFF	OFF	ON	OFF	OFF	ON
Turn On Time	OFF	OFF	ON	OFF	ON	OFF	OFF	OFF	OFF	OFF	OFF	OFF

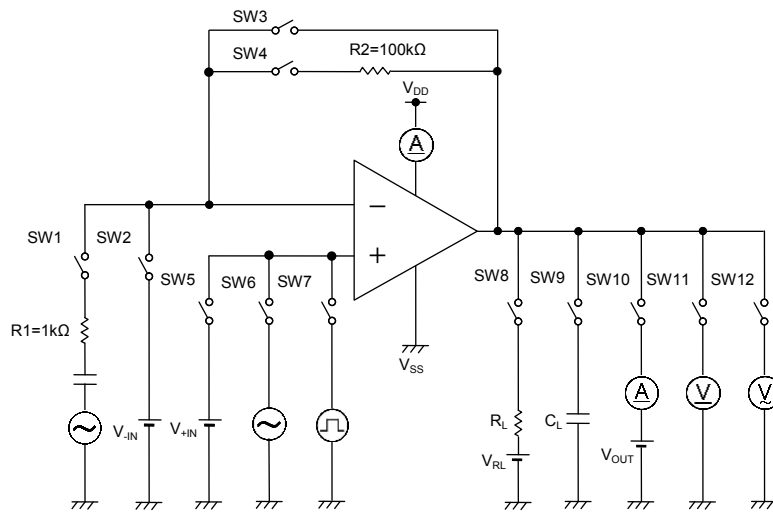

Figure 74. Test Circuit 2 (Each Op-Amp)

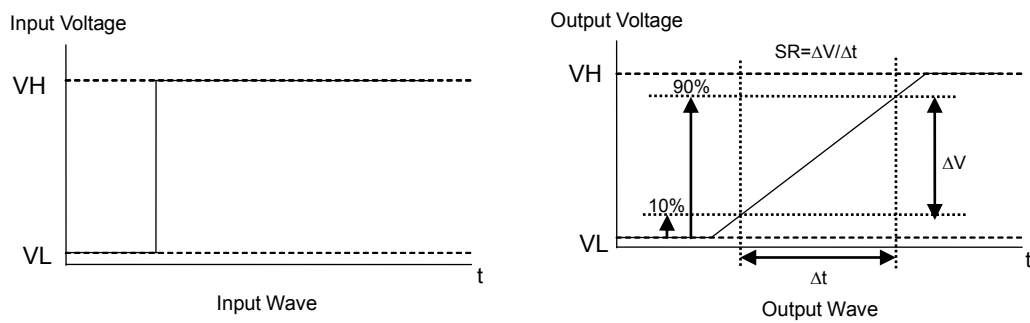

Figure 75. Slew Rate Input and Output Wave



Application Information – continued

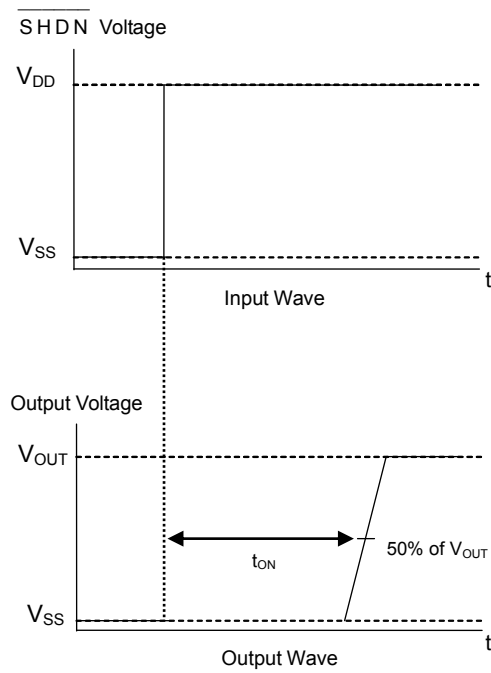

Figure 76. Turn On Time Input and Output Wave

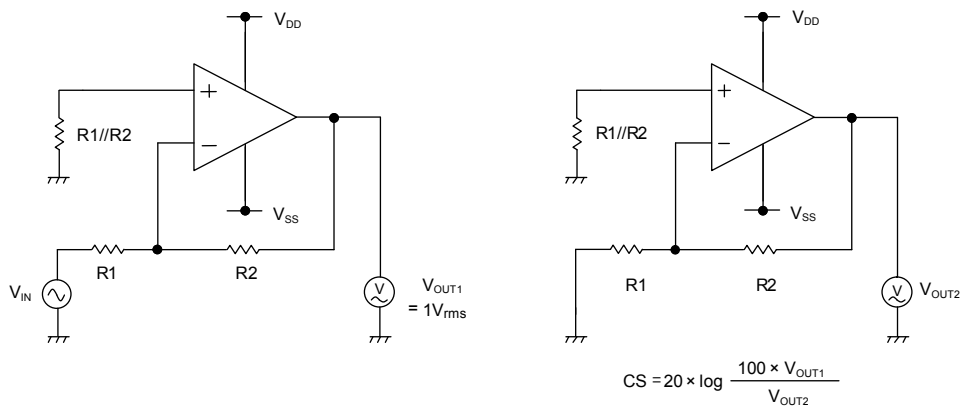

Figure 77. Test Circuit 3 (Channel Separation)  
 ( $R1=1k\Omega$ ,  $R2=100k\Omega$ )

## Application Information – continued

**1. Unused Circuits**

When there are unused op-amps, it is recommended that they are connected as in Figure 78, setting the non-inverting input pin to a potential within the in-phase input voltage range ( $V_{ICM}$ ).

**2. Input Voltage**

Applying  $V_{DD}+0.3V$  to the input pin is possible without causing deterioration of the electrical characteristics or destruction. However, this does not ensure normal circuit operation. Please note that the circuit operates normally only when the input voltage is within the common mode input voltage range of the electric characteristics.

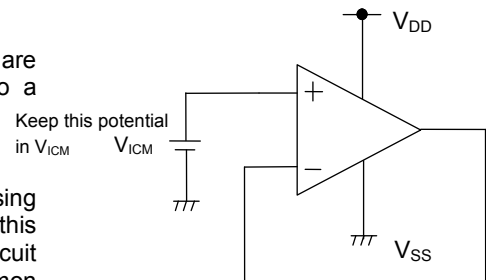

Figure 78. Example of Application Circuit for Unused Op-amp

**3. Power Supply(single/dual)**

The operational amplifiers operate when the voltage supplied is between  $V_{DD}$  and  $V_{SS}$ . Therefore, the single supply operational amplifiers can be used as dual supply operational amplifiers as well.

**4. Output Capacitor**

If a large capacitor is connected between the output pin and  $V_{SS}$  pin, current from the charged capacitor will flow into the output pin and may destroy the IC when the  $V_{DD}$  pin is shorted to ground or pulled down to 0V. Use a capacitor smaller than 0.1 $\mu$ F between output pin and  $V_{SS}$  pin.

**5. Oscillation by Output Capacitor**

Please pay attention to the oscillation by output capacitor and in designing an application of negative feedback loop circuit with these ICs.

**6. Latch Up**

Be careful of input voltage that exceed the  $V_{DD}$  and  $V_{SS}$ . When CMOS device have sometimes occur latch up and protect the IC from abnormally noise.

**7. Shutdown Terminal**

The shutdown terminal can't be left unconnected. In case shutdown operation is not needed, the shutdown pin should be connected to  $V_{DD}$  when the IC is used. Leaving the shutdown pin floating will result in an undefined operation mode, either shutdown or active, or even oscillating between the two modes.

I/O Equivalent Circuit

Symbol	Pin No.			Equivalent Circuit
	TLR341G	TLR342xxx	TLR344xxx	
+IN -IN	1,3	2,3,5,6	2,3,5,6, 9,10,12,13	
OUT	4	1,7	1,7,8,14	
VDD	6	8	4	
$\overline{\text{SHDN}}$	5	-	-	

**Application Example**

## ○Voltage Follower

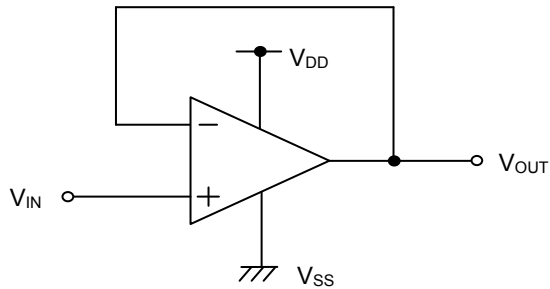

Figure 79. Voltage Follower Circuit

Voltage gain is 0dB.

Using this circuit, the output voltage ( $V_{OUT}$ ) is configured to be equal to the input voltage ( $V_{IN}$ ). This circuit also stabilizes the output voltage ( $V_{OUT}$ ) due to high input impedance and low output impedance. Computation for output voltage ( $V_{OUT}$ ) is shown below.

$$V_{OUT}=V_{IN}$$

## ○Inverting Amplifier

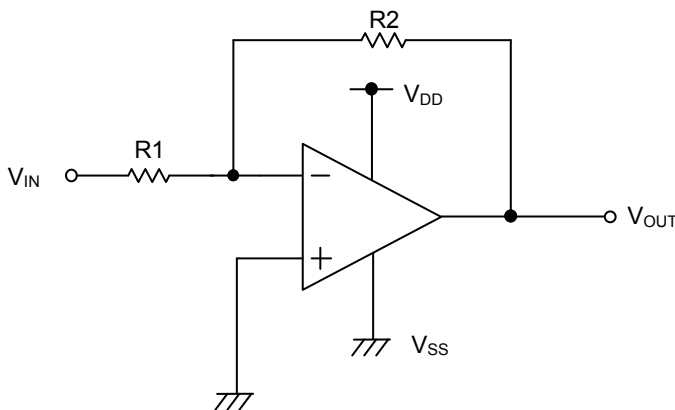

Figure 80. Inverting Amplifier Circuit

For inverting amplifier, input voltage ( $V_{IN}$ ) is amplified by a voltage gain and depends on the ratio of  $R1$  and  $R2$ . The out-of-phase output voltage is shown in the next expression

$$V_{OUT}=-\left(\frac{R2}{R1}\right) \cdot V_{IN}$$

This circuit has input impedance equal to  $R1$ .

## ○Non-inverting Amplifier

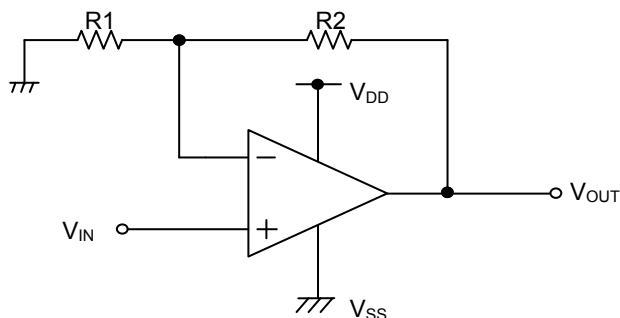

Figure 81. Non-inverting Amplifier Circuit

For non-inverting amplifier, input voltage ( $V_{IN}$ ) is amplified by a voltage gain, which depends on the ratio of  $R1$  and  $R2$ . The output voltage ( $V_{OUT}$ ) is in-phase with the input voltage ( $V_{IN}$ ) and is shown in the next expression.

$$V_{OUT}=\left(1 + \frac{R2}{R1}\right) \cdot V_{IN}$$

Effectively, this circuit has high input impedance since its input side is the same as that of the operational amplifier.

**Power Dissipation**

Power dissipation (total loss) indicates the power that the IC can consume at  $T_A=25^\circ\text{C}$  (normal temperature). As the IC consumes power, it heats up, causing its temperature to be higher than the ambient temperature. The allowable temperature that the IC can accept is limited. This depends on the circuit configuration, manufacturing process, and consumable power. Power dissipation is determined by the allowable temperature within the IC (maximum junction temperature) and the thermal resistance of the package used (heat dissipation capability). Maximum junction temperature is typically equal to the maximum storage temperature. The heat generated through the consumption of power by the IC radiates from the mold resin or lead frame of the package. Thermal resistance, represented by the symbol  $\theta_{JA}^\circ\text{C/W}$ , indicates this heat dissipation capability. Similarly, the temperature of an IC inside its package can be estimated by thermal resistance. Figure 82(a) shows the model of the thermal resistance of a package. The equation below shows how to compute the Thermal resistance ( $\theta_{JA}$ ), given the ambient temperature ( $T_A$ ), maximum junction temperature ( $T_{Jmax}$ ), and power dissipation ( $P_D$ ).

$$\theta_{JA} = (T_{Jmax} - T_A) / P_D \quad ^\circ\text{C/W}$$

The derating curve in Figure 82(b) indicates the power that the IC can consume with reference to ambient temperature. Power consumption of the IC begins to attenuate at certain temperatures. This gradient is determined by Thermal resistance ( $\theta_{JA}$ ), which depends on the chip size, power consumption, package, ambient temperature, package condition, wind velocity, etc. This may also vary even when the same of package is used. Thermal reduction curve indicates a reference value measured at a specified condition. Figure 82 (c), (d), and (e) shows an example of the derating curve for TLR341G, TLR342xxx, and TLR344xxx, respectively.

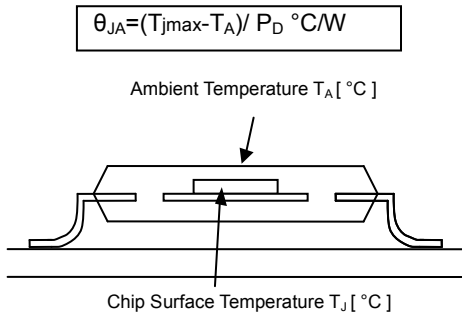

(a) Thermal Resistance

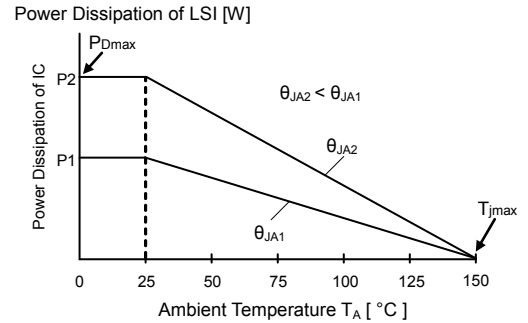

(b) Derating Curve

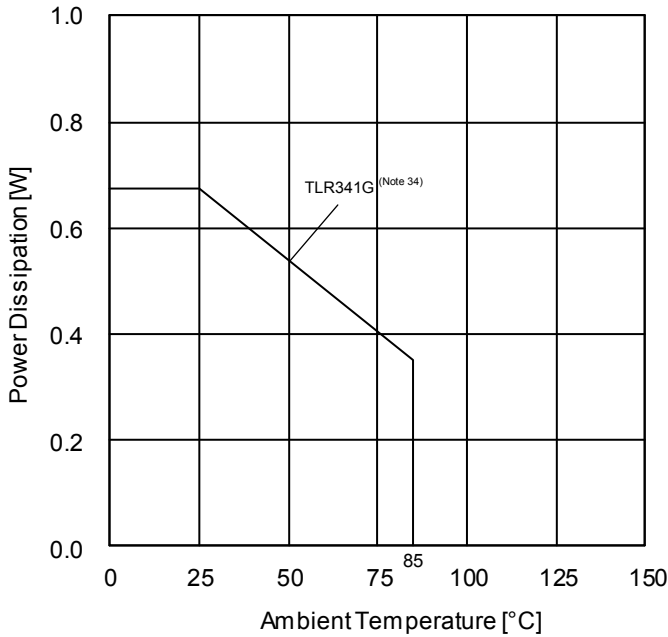

(c) TLR341G

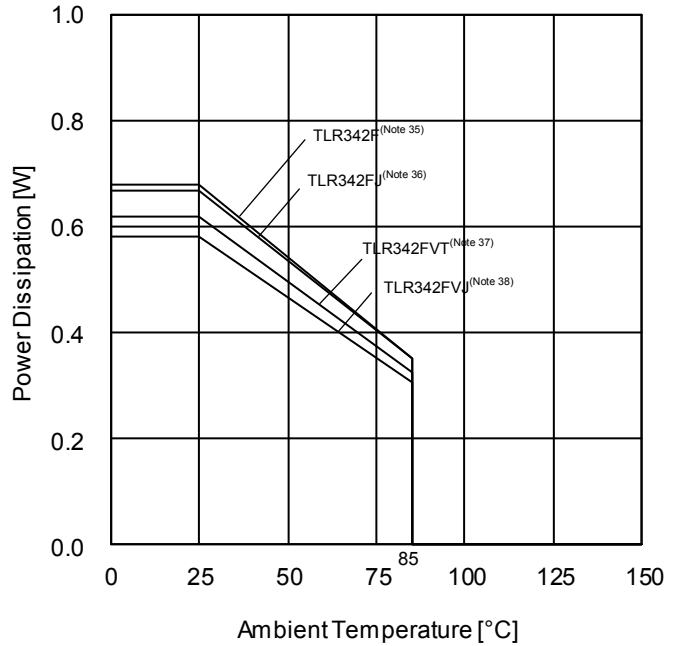

(d) TLR342xxx

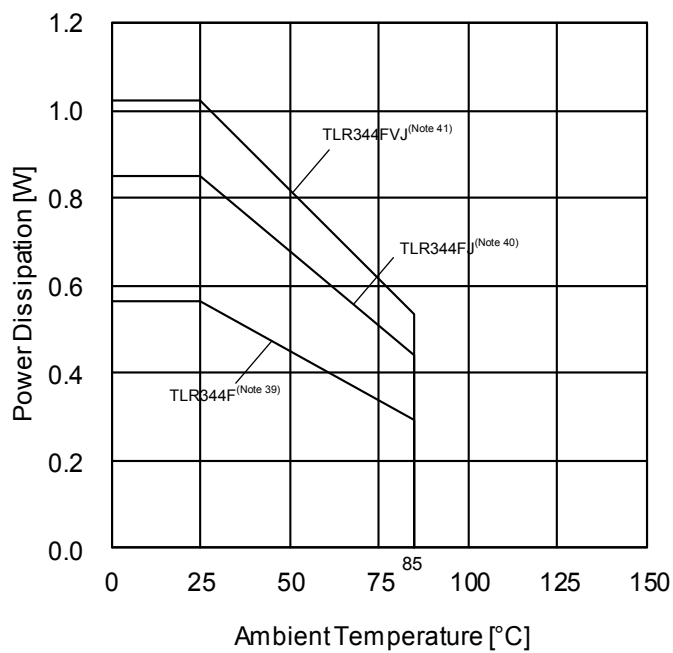

(e) TLR344xxx

(Note 34)	(Note 35)	(Note 36)	(Note 37)	(Note 38)	(Note 39)	(Note 40)	(Note 41)	Unit
5.4	5.5	5.4	5.0	4.7	4.5	8.2	6.8	mW/°C

When using the unit above  $T_A = 25^\circ\text{C}$ , subtract the value above per Celsius degree.  
 Power dissipation is the value when FR4 glass epoxy board 70mm × 70mm × 1.6mm (copper foil area less than 3%) is mounted.

Figure 82. Thermal Resistance and Derating Curve

## Operational Notes

### 1. Reverse Connection of Power Supply

Connecting the power supply in reverse polarity can damage the IC. Take precautions against reverse polarity when connecting the power supply, such as mounting an external diode between the power supply and the IC's power supply pins.

### 2. Power Supply Lines

Design the PCB layout pattern to provide low impedance supply lines. Furthermore, connect a capacitor to ground at all power supply pins. Consider the effect of temperature and aging on the capacitance value when using electrolytic capacitors.

### 3. Ground Voltage

Ensure that no pins are at a voltage below that of the ground pin at any time, even during transient condition.

### 4. Ground Wiring Pattern

When using both small-signal and large-current ground traces, the two ground traces should be routed separately but connected to a single ground at the reference point of the application board to avoid fluctuations in the small-signal ground caused by large currents. Also ensure that the GND traces of external components do not cause variations on the GND voltage. The power supply and ground lines must be as short and thick as possible to reduce line impedance.

### 5. Thermal Consideration

Should by any chance the power dissipation rating be exceeded, the rise in temperature of the chip may result in deterioration of the properties of the chip. The absolute maximum rating of the  $P_D$  stated in this specification is when the IC is mounted on a 70mm x 70mm x 1.6mm glass epoxy board. In case of exceeding this absolute maximum rating, increase the board size and copper area to prevent exceeding the  $P_D$  rating.

### 6. Recommended Operating Conditions

These conditions represent a range within which the expected characteristics of the IC can be approximately obtained. The electrical characteristics are guaranteed under the conditions of each parameter.

### 7. Inrush Current

When power is first supplied to the IC, it is possible that the internal logic may be unstable and inrush current may flow instantaneously due to the internal powering sequence and delays, especially if the IC has more than one power supply. Therefore, give special consideration to power coupling capacitance, power wiring, width of ground wiring, and routing of connections.

### 8. Operation Under Strong Electromagnetic Field

Operating the IC in the presence of a strong electromagnetic field may cause the IC to malfunction.

### 9. Testing on Application Boards

When testing the IC on an application board, connecting a capacitor directly to a low-impedance output pin may subject the IC to stress. Always discharge capacitors completely after each process or step. The IC's power supply should always be turned off completely before connecting or removing it from the test setup during the inspection process. To prevent damage from static discharge, ground the IC during assembly and use similar precautions during transport and storage.

### 10. Inter-pin Short and Mounting Errors

Ensure that the direction and position are correct when mounting the IC on the PCB. Incorrect mounting may result in damaging the IC. Avoid nearby pins being shorted to each other especially to ground, power supply and output pin. Inter-pin shorts could be due to many reasons such as metal particles, water droplets (in very humid environment) and unintentional solder bridge deposited in between pins during assembly to name a few.

### 11. Unused Input Pins

Input pins of an IC are often connected to the gate of a MOS transistor. The gate has extremely high impedance and extremely low capacitance. If left unconnected, the electric field from the outside can easily charge it. The small charge acquired in this way is enough to produce a significant effect on the conduction through the transistor and cause unexpected operation of the IC. So unless otherwise specified, unused input pins should be connected to the power supply or ground line.

### 12. Regarding the Input Pin of the IC

In the construction of this IC, P-N junctions are inevitably formed creating parasitic diodes or transistors. The operation of these parasitic elements can result in mutual interference among circuits, operational faults, or physical damage. Therefore, conditions which cause these parasitic elements to operate, such as applying a voltage to an input pin lower than the ground voltage should be avoided. Furthermore, do not apply a voltage to the input pins when no power supply voltage is applied to the IC. Even if the power supply voltage is applied, make sure that the input pins have voltages within the values specified in the electrical characteristics of this IC.

Physical Dimension, Tape and Reel Information

Package Name	SSOP6
--------------	-------

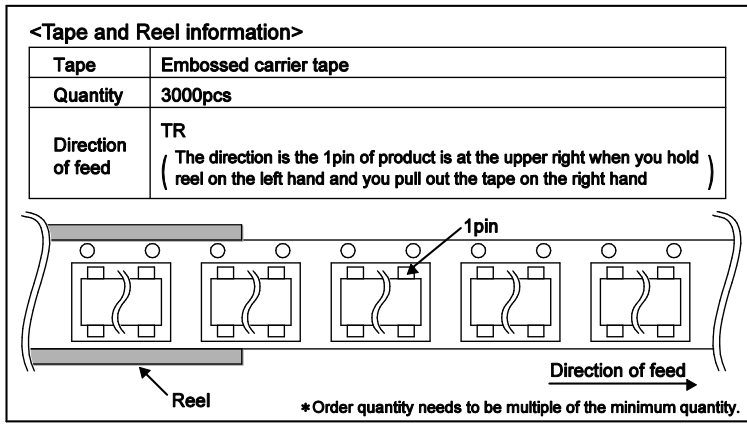
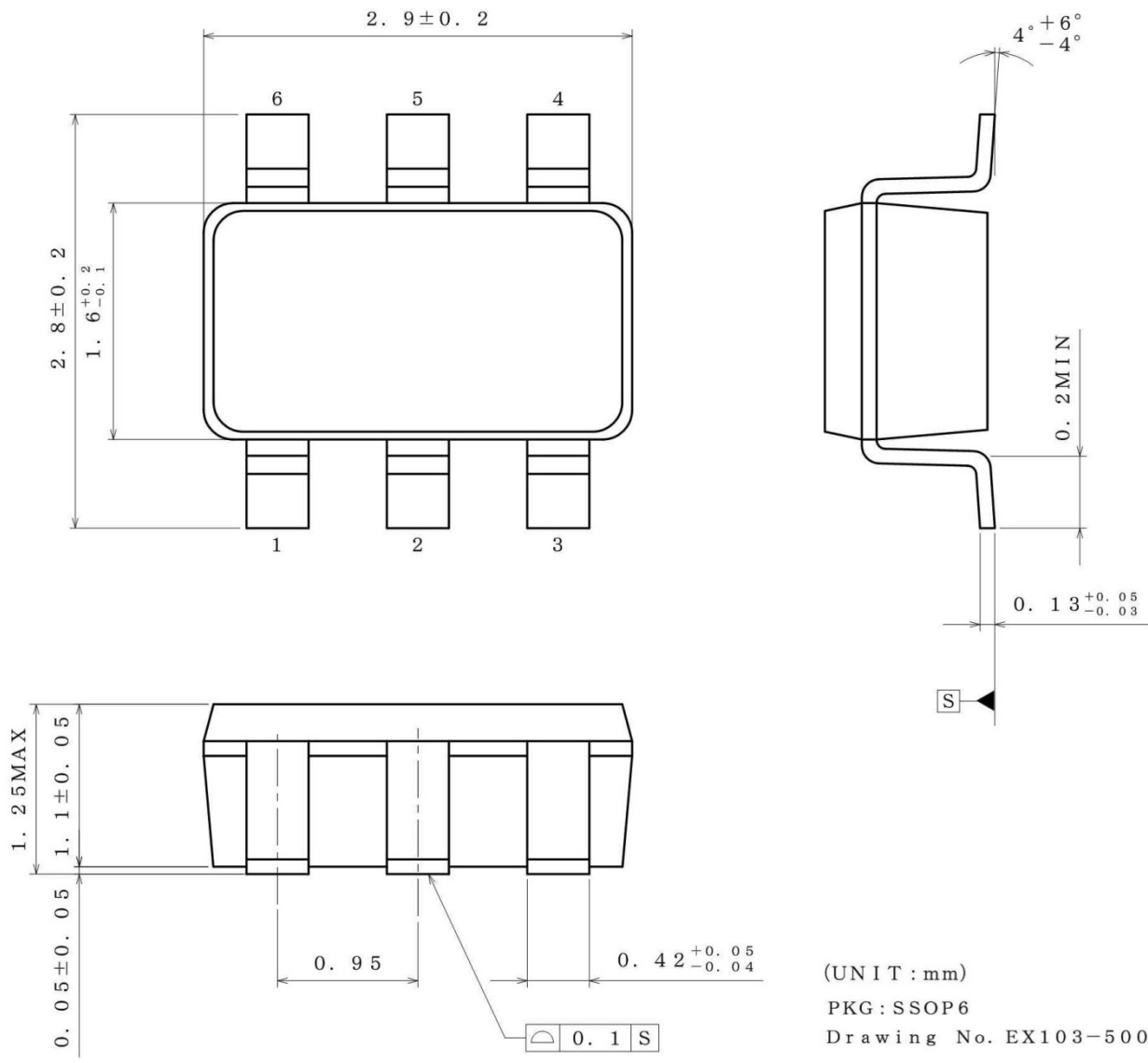



Physical Dimension, Tape and Reel Information – continued

Package Name	SOP8
--------------	------

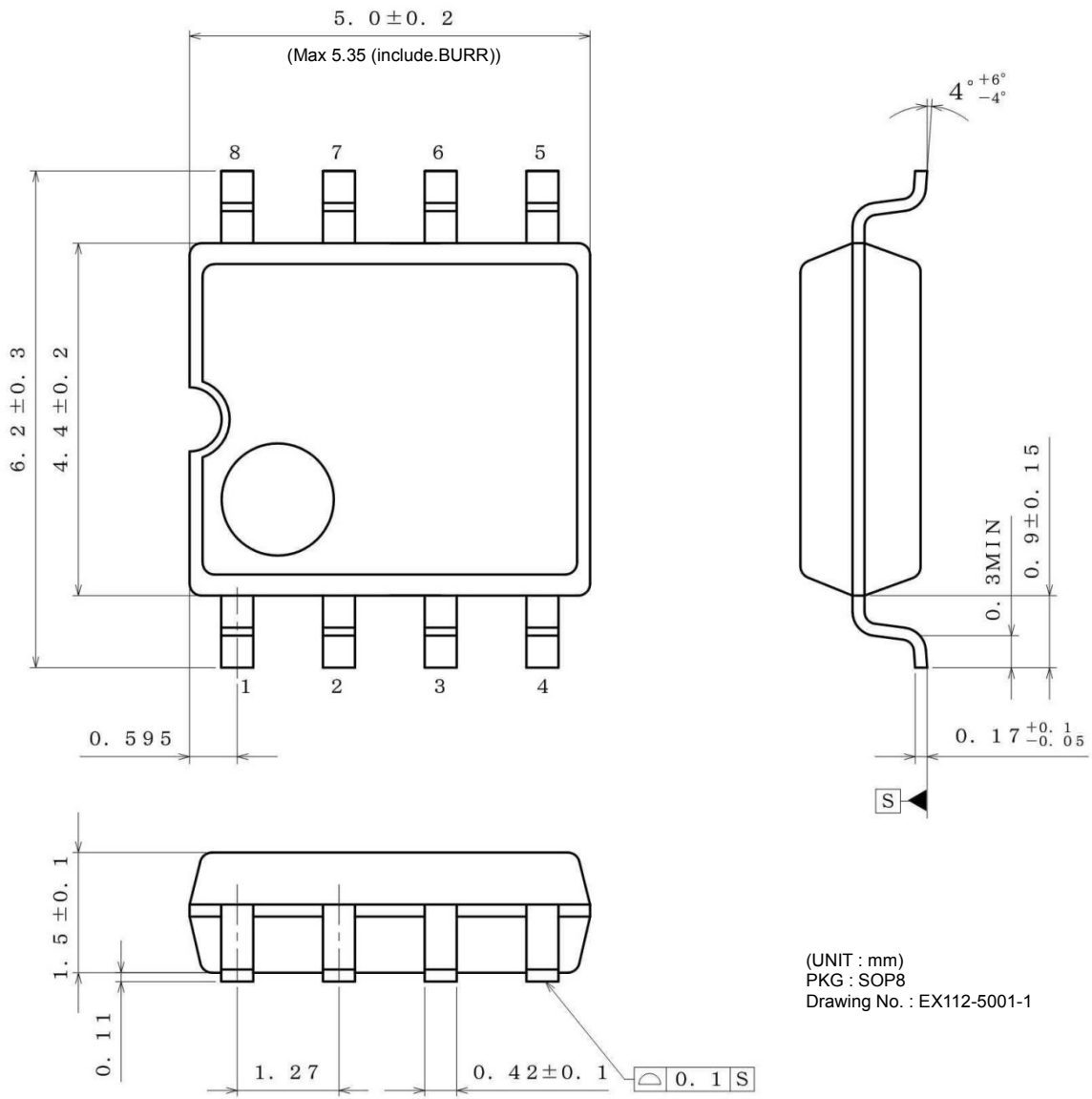

(UNIT : mm)  
 PKG : SOP8  
 Drawing No. : EX112-5001-1

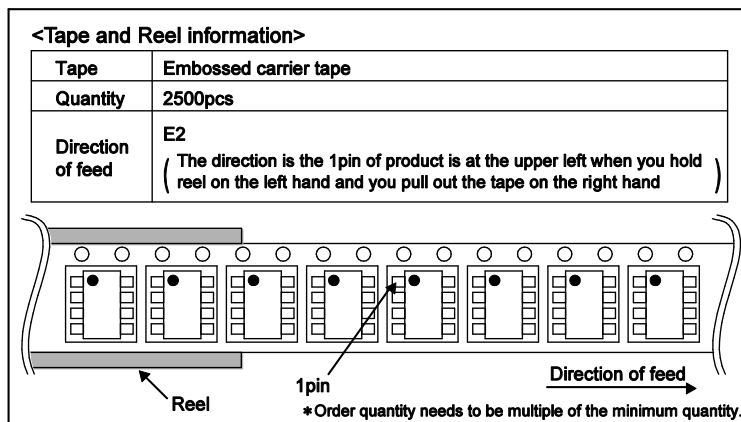

Physical Dimension, Tape and Reel Information – continued

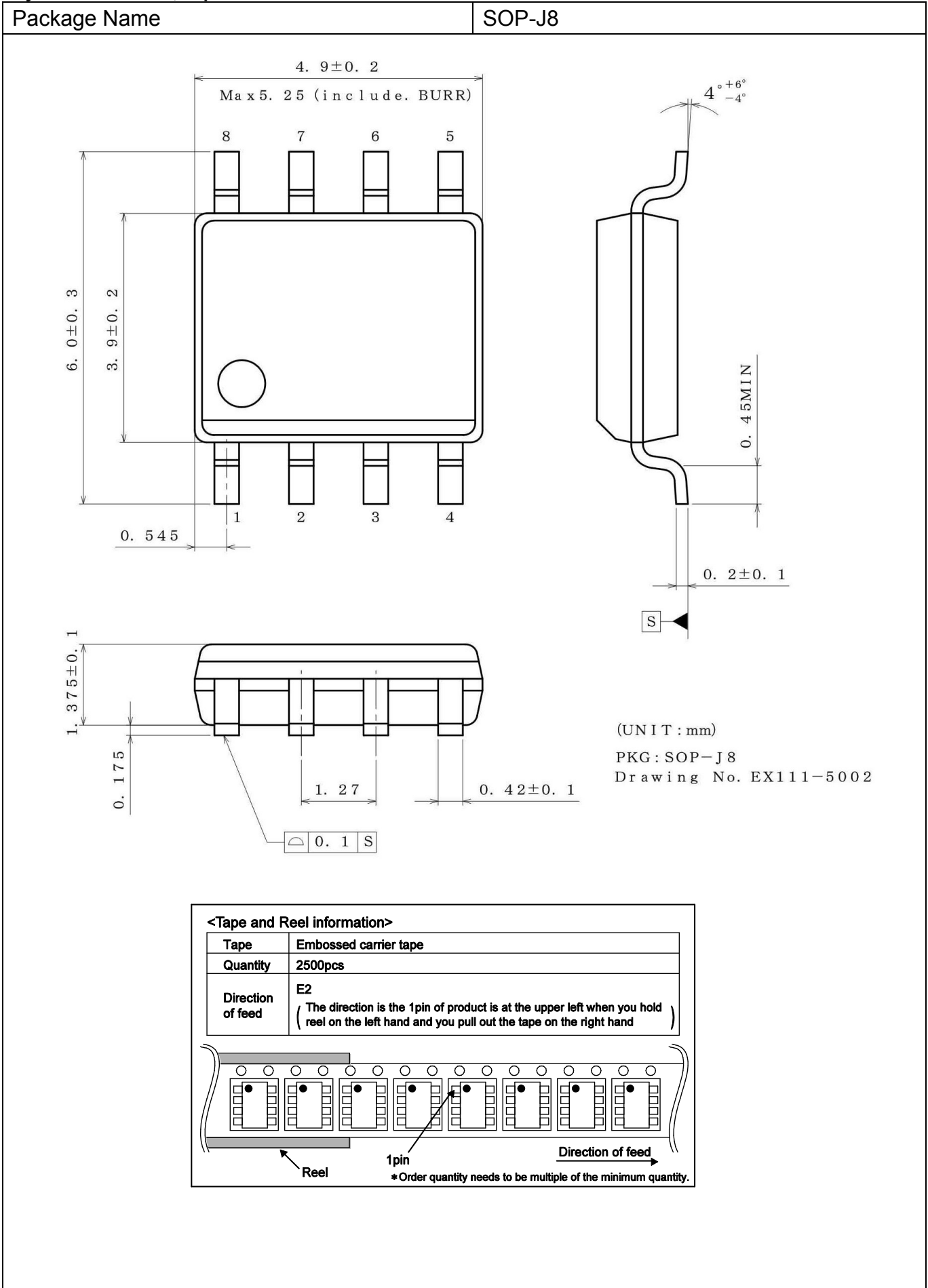

Physical Dimension, Tape and Reel Information – continued

Package Name	TSSOP-B8
--------------	----------

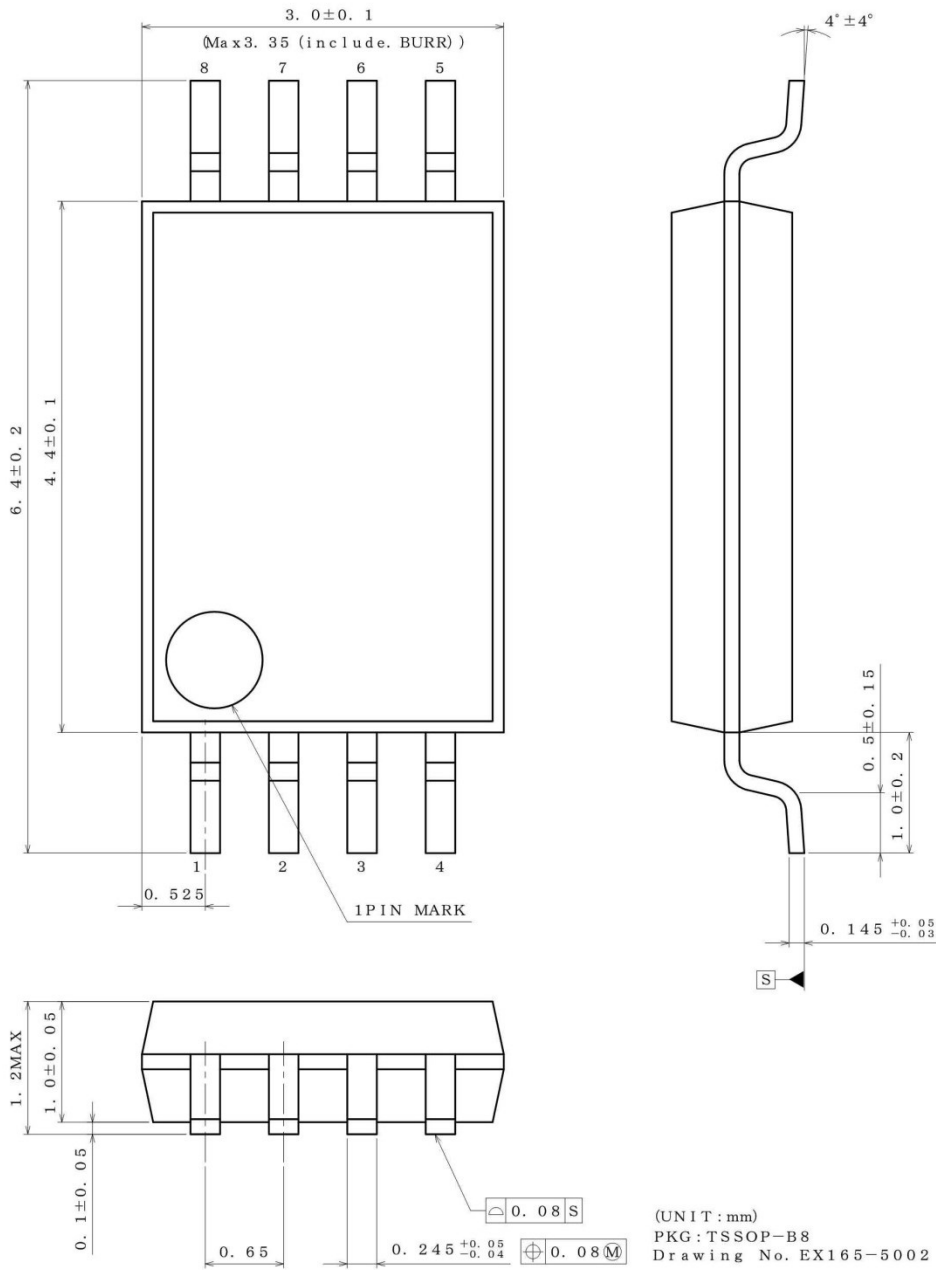

**<Tape and Reel information>**

Tape	Embossed carrier tape
Quantity	3000pcs
Direction of feed	E2 ( The direction is the 1pin of product is at the upper left when you hold reel on the left hand and you pull out the tape on the right hand )

Reel 1pin Direction of feed

\*Order quantity needs to be multiple of the minimum quantity.

Physical Dimension, Tape and Reel Information – continued

Package Name	TSSOP-B8J
--------------	-----------

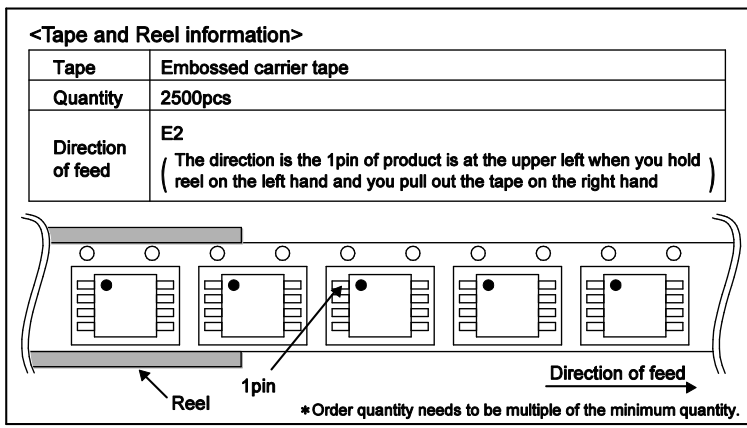
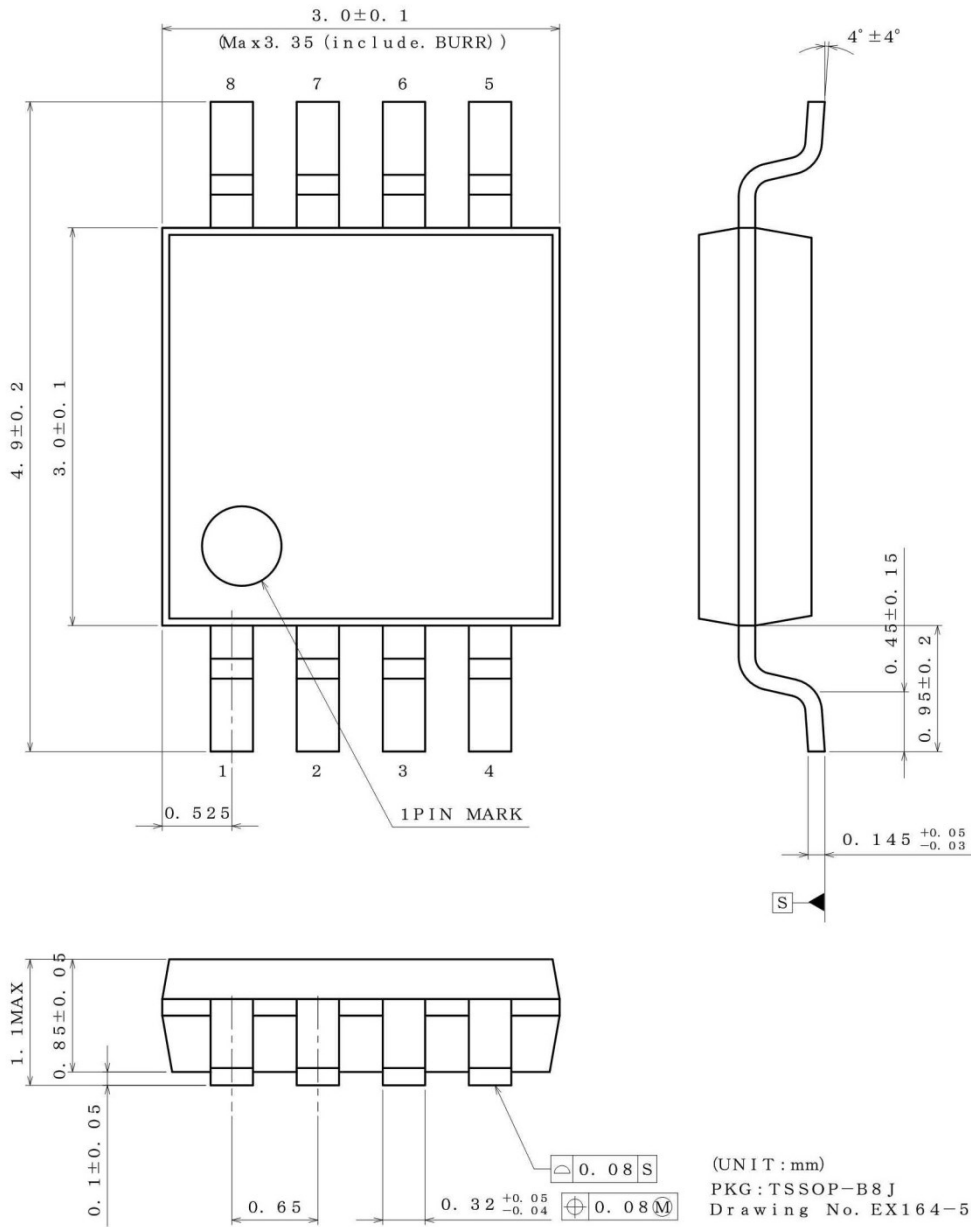

Physical Dimension, Tape and Reel Information – continued

Package Name	SOP14
--------------	-------

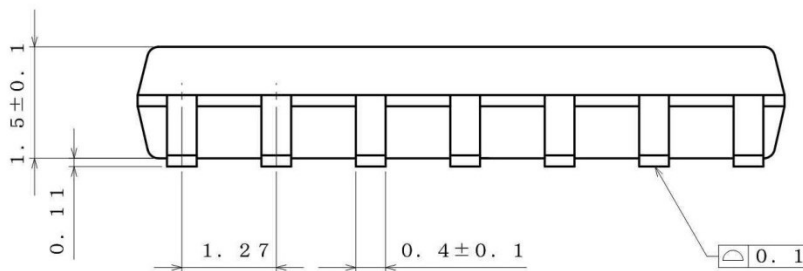
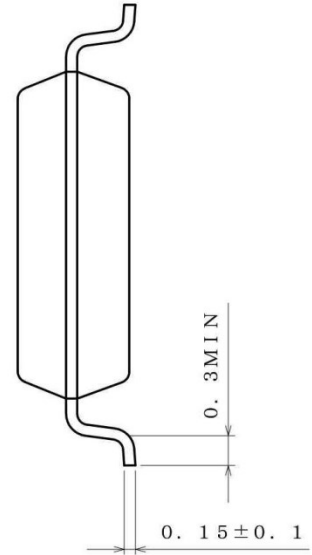
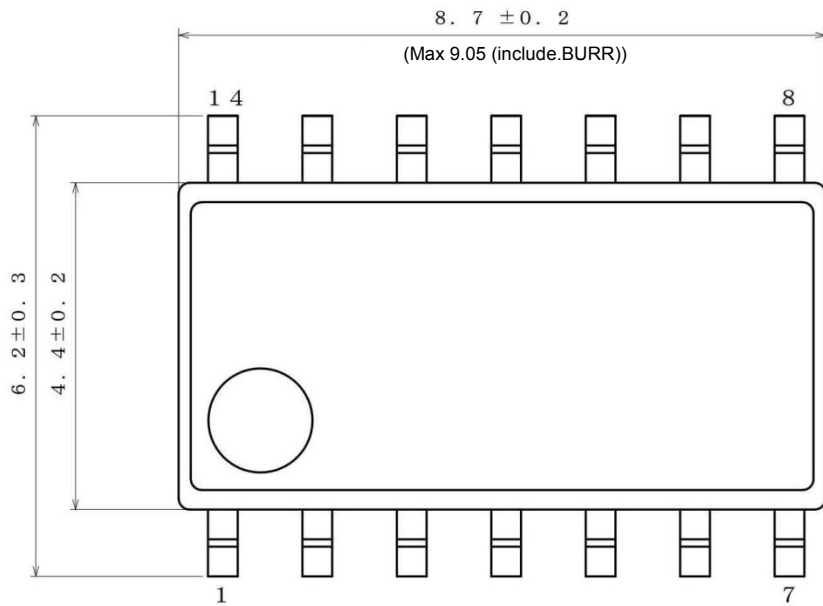

(UNIT : mm)  
PKG : SOP14  
Drawing No. : EX113-5001

**<Tape and Reel information>**

Tape	Embossed carrier tape
Quantity	2500pcs
Direction of feed	E2 ( The direction is the 1pin of product is at the upper left when you hold reel on the left hand and you pull out the tape on the right hand )

Reel

1pin

Direction of feed

\*Order quantity needs to be multiple of the minimum quantity.

Physical Dimension, Tape and Reel Information – continued

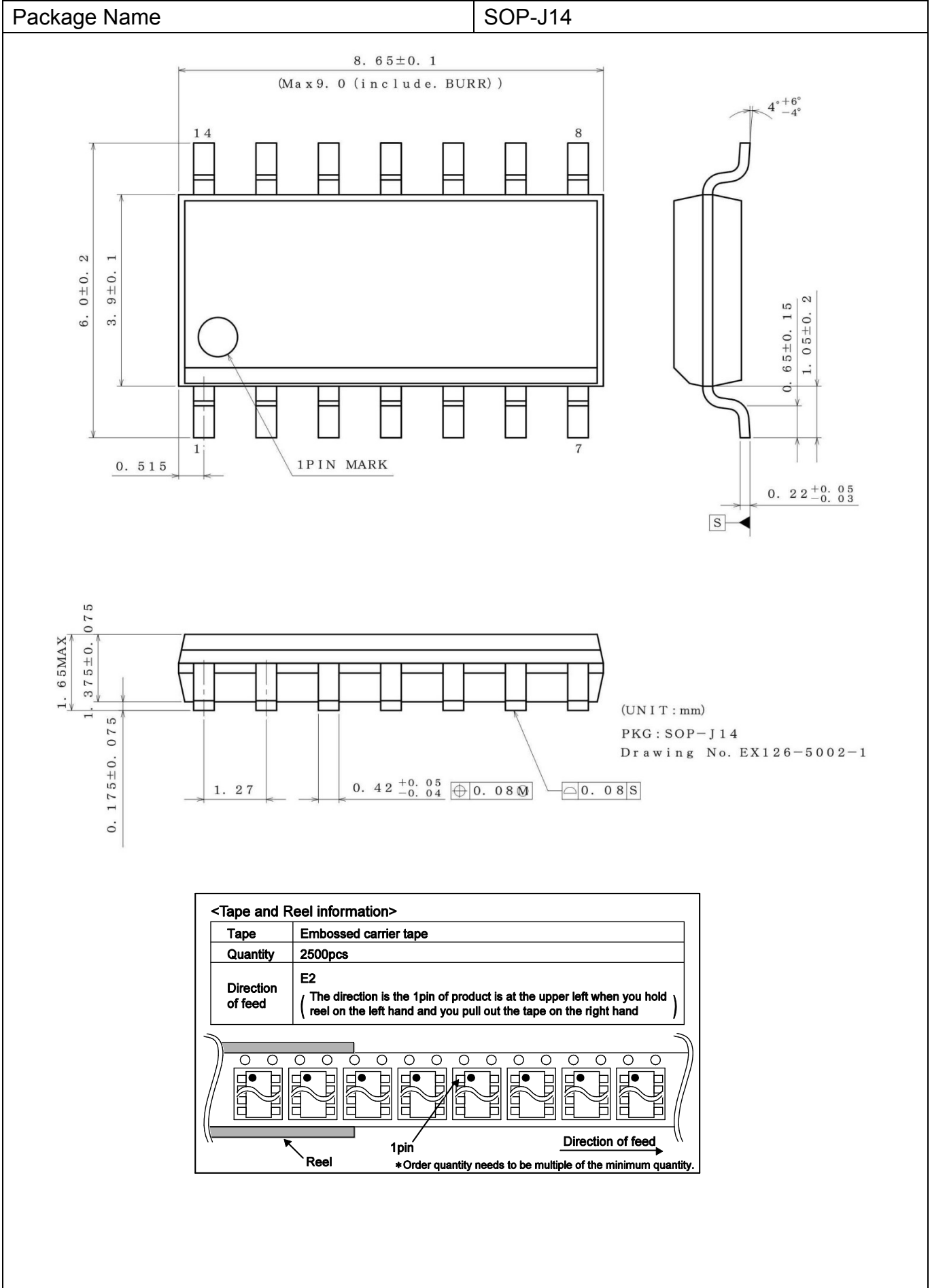

Physical Dimension, Tape and Reel Information – continued

Package Name	TSSOP-B14J
--------------	------------

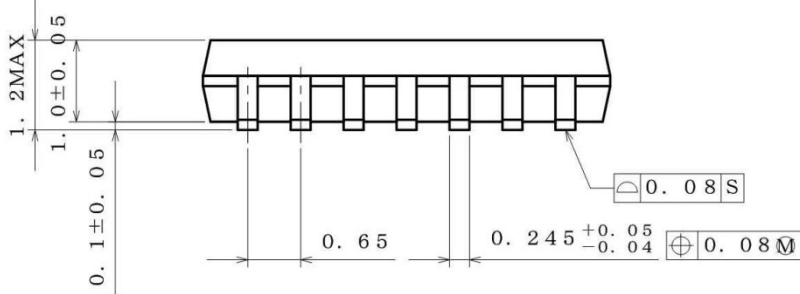
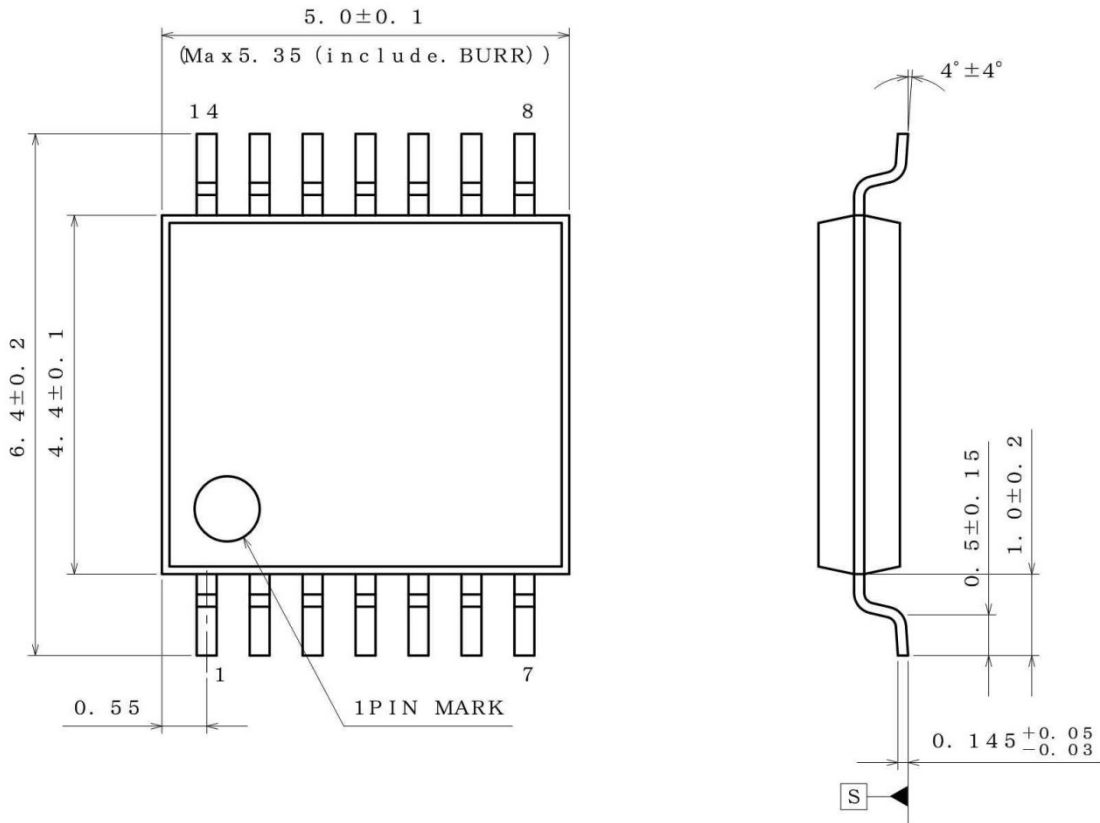

(UNIT : mm)  
 PKG : TSSOP-B14J  
 Drawing No. EX166-5002-1

**<Tape and Reel information>**

Tape	Embossed carrier tape
Quantity	2500pcs
Direction of feed	E2 (The direction is the 1pin of product is at the upper left when you hold reel on the left hand and you pull out the tape on the right hand)

\* Order quantity needs to be multiple of the minimum quantity.

Ordering Information

T	L	R	3	4	x	x	x	x	-	x	x
---	---	---	---	---	---	---	---	---	---	---	---

Part Number  
 TLR341G  
 TLR342F  
 TLR342FJ  
 TLR342FVT  
 TLR342FVJ  
 TLR344F  
 TLR344FJ  
 TLR344FVJ

Package  
 G : SSOP6  
 F : SOP8  
 : SOP14  
 FJ : SOP-J8  
 : SOP-J14  
 FVT : TSSOP-B8  
 FVJ : TSSOP-B8J  
 : TSSOP-B14J

Packaging and forming specification  
 TR: Embossed tape and reel  
 (SSOP6)  
 E2: Embossed tape and reel  
 (SOP8, SOP-J8, TSSOP-B8,  
 TSSOP-B8J, SOP14, SOP-J14,  
 TSSOP-B14J)

Line-up

T <sub>opr</sub>	Channels	Package		Orderable Part Number
-40°C to +85°C	1ch	SSOP6	Reel of 3000	TLR341G-TR
	2ch	SOP8	Reel of 2500	TLR342F-E2
		SOP-J8	Reel of 2500	TLR342FJ-E2
		TSSOP-B8	Reel of 2500	TLR342FVT-E2
		TSSOP-B8J	Reel of 2500	TLR342FVJ-E2
	4ch	SOP14	Reel of 2500	TLR344F-E2
		SOP-J14	Reel of 2500	TLR344FJ-E2
		TSSOP-B14J	Reel of 2500	TLR344FVJ-E2



Marking Diagram

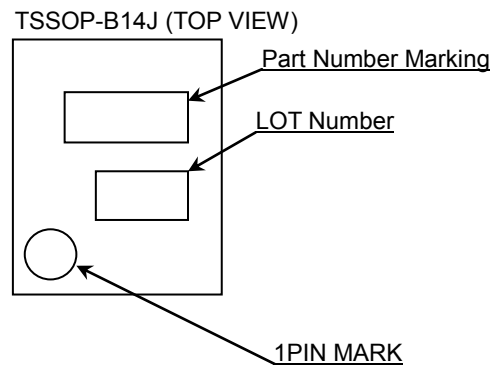
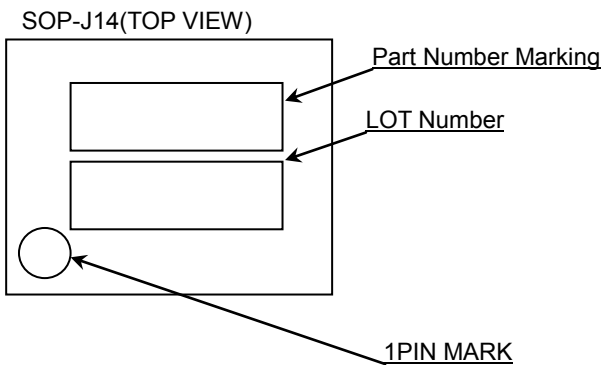
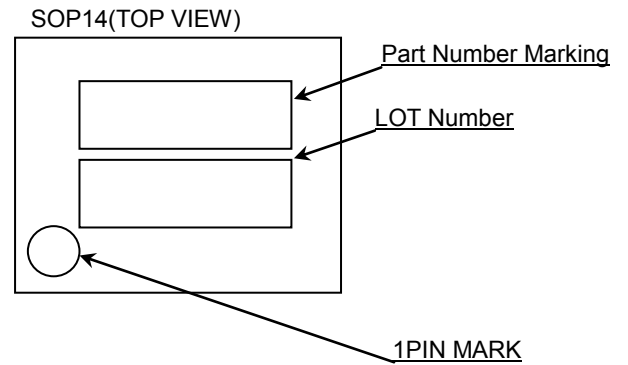
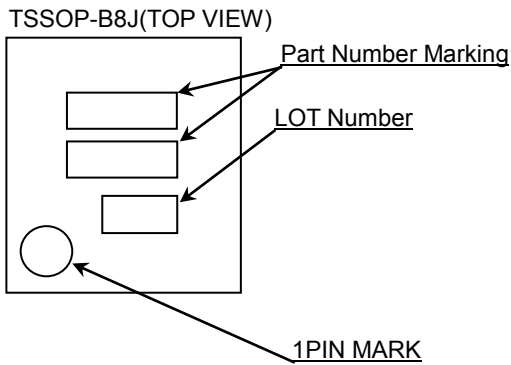
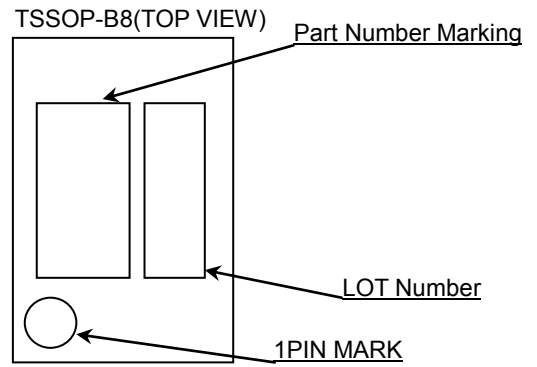
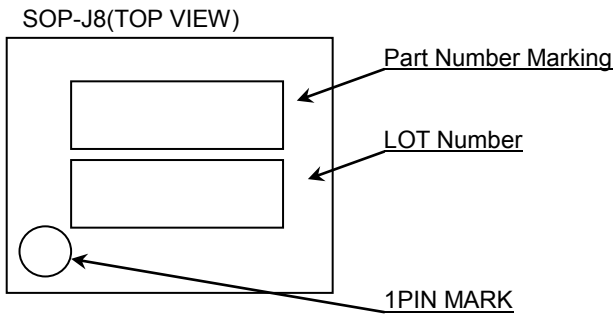
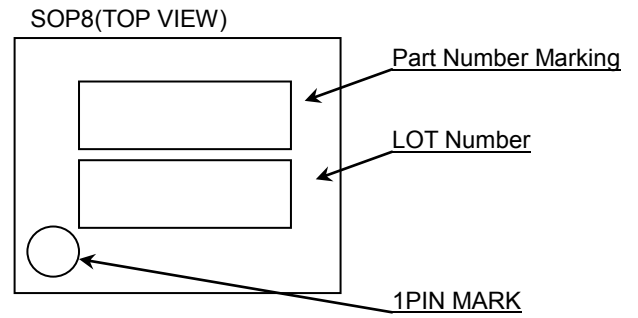
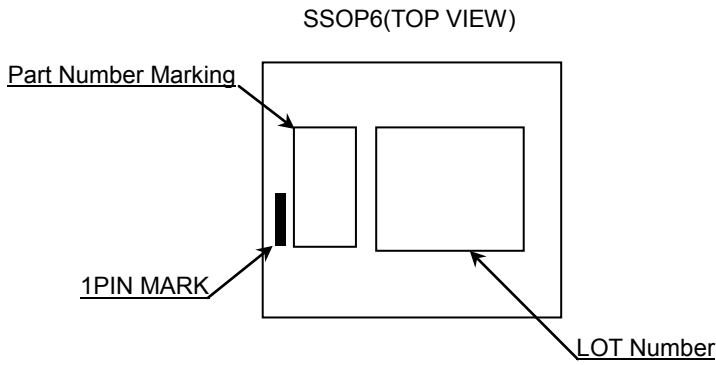

Marking Diagram – continued

Product Name		Package Type	Marking
TLR341	G	SSOP6	BC
TLR342	F	SOP8	T342
	FJ	SOP-J8	T342
	FVT	TSSOP-B8	T342
	FVJ	TSSOP-B8J	T342
TLR344	F	SOP14	TLR344F
	FJ	SOP-J14	TLR344FJ
	FVJ	TSSOP-B14J	T344

Land Pattern Data

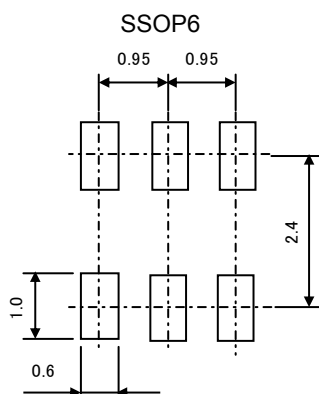

SOP8, SOP-J8, TSSOP-B8, TSSOP-B8J, SOP14, SOP-J14, TSSOP-B14J

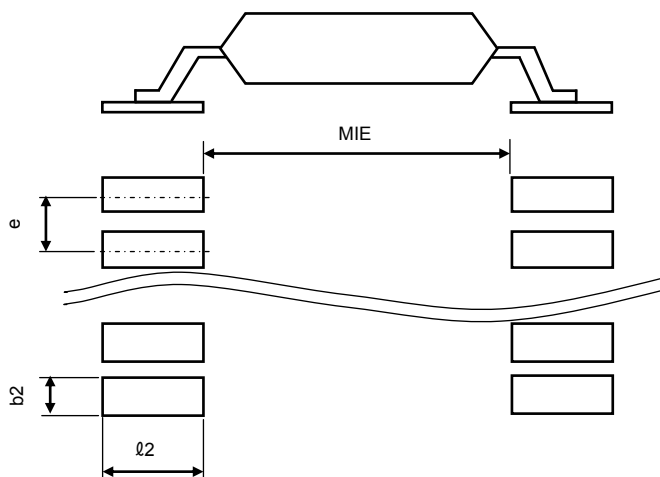

All dimensions in mm

Package	Land pitch e	Land space MIE	Land length $\geq l2$	Land width b2
SSOP6	0.95	2.4	1.0	0.6
SOP8 SOP14	1.27	4.60	1.10	0.76
SOP-J8 SOP-J14	1.27	3.9	1.35	0.76
TSSOP-B8 TSSOP-B14J	0.65	4.60	1.20	0.35
TSSOP-B8J	0.65	3.20	1.15	0.35

**Revision History**

Date	Revision	Changes
29.Aug.2014	001	New Release
19.Mar.2015	002	Add TLR342FJ, TLR342FVT, TLR342FVJ, TLR344F
14.Oct.2015	003	Add TLR344FJ and TLR344FVJ
03.Feb.2016	004	Add TLR341G

# Notice

## Precaution on using ROHM Products

- Our Products are designed and manufactured for application in ordinary electronic equipments (such as AV equipment, OA equipment, telecommunication equipment, home electronic appliances, amusement equipment, etc.). If you intend to use our Products in devices requiring extremely high reliability (such as medical equipment <sup>(Note 1)</sup>, transport equipment, traffic equipment, aircraft/spacecraft, nuclear power controllers, fuel controllers, car equipment including car accessories, safety devices, etc.) and whose malfunction or failure may cause loss of human life, bodily injury or serious damage to property ("Specific Applications"), please consult with the ROHM sales representative in advance. Unless otherwise agreed in writing by ROHM in advance, ROHM shall not be in any way responsible or liable for any damages, expenses or losses incurred by you or third parties arising from the use of any ROHM's Products for Specific Applications.

(Note1) Medical Equipment Classification of the Specific Applications

JAPAN	USA	EU	CHINA
CLASS III	CLASS III	CLASS II b	CLASS III
CLASS IV		CLASS III	

- ROHM designs and manufactures its Products subject to strict quality control system. However, semiconductor products can fail or malfunction at a certain rate. Please be sure to implement, at your own responsibilities, adequate safety measures including but not limited to fail-safe design against the physical injury, damage to any property, which a failure or malfunction of our Products may cause. The following are examples of safety measures:
  - Installation of protection circuits or other protective devices to improve system safety
  - Installation of redundant circuits to reduce the impact of single or multiple circuit failure
- Our Products are designed and manufactured for use under standard conditions and not under any special or extraordinary environments or conditions, as exemplified below. Accordingly, ROHM shall not be in any way responsible or liable for any damages, expenses or losses arising from the use of any ROHM's Products under any special or extraordinary environments or conditions. If you intend to use our Products under any special or extraordinary environments or conditions (as exemplified below), your independent verification and confirmation of product performance, reliability, etc. prior to use, must be necessary:
  - Use of our Products in any types of liquid, including water, oils, chemicals, and organic solvents
  - Use of our Products outdoors or in places where the Products are exposed to direct sunlight or dust
  - Use of our Products in places where the Products are exposed to sea wind or corrosive gases, including Cl<sub>2</sub>, H<sub>2</sub>S, NH<sub>3</sub>, SO<sub>2</sub>, and NO<sub>2</sub>
  - Use of our Products in places where the Products are exposed to static electricity or electromagnetic waves
  - Use of our Products in proximity to heat-producing components, plastic cords, or other flammable items
  - Sealing or coating our Products with resin or other coating materials
  - Use of our Products without cleaning residue of flux (even if you use no-clean type fluxes, cleaning residue of flux is recommended); or Washing our Products by using water or water-soluble cleaning agents for cleaning residue after soldering
  - Use of the Products in places subject to dew condensation
- The Products are not subject to radiation-proof design.
- Please verify and confirm characteristics of the final or mounted products in using the Products.
- In particular, if a transient load (a large amount of load applied in a short period of time, such as pulse. is applied, confirmation of performance characteristics after on-board mounting is strongly recommended. Avoid applying power exceeding normal rated power; exceeding the power rating under steady-state loading condition may negatively affect product performance and reliability.
- De-rate Power Dissipation depending on ambient temperature. When used in sealed area, confirm that it is the use in the range that does not exceed the maximum junction temperature.
- Confirm that operation temperature is within the specified range described in the product specification.
- ROHM shall not be in any way responsible or liable for failure induced under deviant condition from what is defined in this document.

## Precaution for Mounting / Circuit board design

- When a highly active halogenous (chlorine, bromine, etc.) flux is used, the residue of flux may negatively affect product performance and reliability.
- In principle, the reflow soldering method must be used on a surface-mount products, the flow soldering method must be used on a through hole mount products. If the flow soldering method is preferred on a surface-mount products, please consult with the ROHM representative in advance.

For details, please refer to ROHM Mounting specification

### Precautions Regarding Application Examples and External Circuits

1. If change is made to the constant of an external circuit, please allow a sufficient margin considering variations of the characteristics of the Products and external components, including transient characteristics, as well as static characteristics.
2. You agree that application notes, reference designs, and associated data and information contained in this document are presented only as guidance for Products use. Therefore, in case you use such information, you are solely responsible for it and you must exercise your own independent verification and judgment in the use of such information contained in this document. ROHM shall not be in any way responsible or liable for any damages, expenses or losses incurred by you or third parties arising from the use of such information.

### Precaution for Electrostatic

This Product is electrostatic sensitive product, which may be damaged due to electrostatic discharge. Please take proper caution in your manufacturing process and storage so that voltage exceeding the Products maximum rating will not be applied to Products. Please take special care under dry condition (e.g. Grounding of human body / equipment / solder iron, isolation from charged objects, setting of Ionizer, friction prevention and temperature / humidity control).

### Precaution for Storage / Transportation

1. Product performance and soldered connections may deteriorate if the Products are stored in the places where:
  - [a] the Products are exposed to sea winds or corrosive gases, including Cl<sub>2</sub>, H<sub>2</sub>S, NH<sub>3</sub>, SO<sub>2</sub>, and NO<sub>2</sub>
  - [b] the temperature or humidity exceeds those recommended by ROHM
  - [c] the Products are exposed to direct sunshine or condensation
  - [d] the Products are exposed to high Electrostatic
2. Even under ROHM recommended storage condition, solderability of products out of recommended storage time period may be degraded. It is strongly recommended to confirm solderability before using Products of which storage time is exceeding the recommended storage time period.
3. Store / transport cartons in the correct direction, which is indicated on a carton with a symbol. Otherwise bent leads may occur due to excessive stress applied when dropping of a carton.
4. Use Products within the specified time after opening a humidity barrier bag. Baking is required before using Products of which storage time is exceeding the recommended storage time period.

### Precaution for Product Label

A two-dimensional barcode printed on ROHM Products label is for ROHM's internal use only.

### Precaution for Disposition

When disposing Products please dispose them properly using an authorized industry waste company.

### Precaution for Foreign Exchange and Foreign Trade act

Since concerned goods might be fallen under listed items of export control prescribed by Foreign exchange and Foreign trade act, please consult with ROHM in case of export.

### Precaution Regarding Intellectual Property Rights

1. All information and data including but not limited to application example contained in this document is for reference only. ROHM does not warrant that foregoing information or data will not infringe any intellectual property rights or any other rights of any third party regarding such information or data.
2. ROHM shall not have any obligations where the claims, actions or demands arising from the combination of the Products with other articles such as components, circuits, systems or external equipment (including software).
3. No license, expressly or implied, is granted hereby under any intellectual property rights or other rights of ROHM or any third parties with respect to the Products or the information contained in this document. Provided, however, that ROHM will not assert its intellectual property rights or other rights against you or your customers to the extent necessary to manufacture or sell products containing the Products, subject to the terms and conditions herein.

### Other Precaution

1. This document may not be reprinted or reproduced, in whole or in part, without prior written consent of ROHM.
2. The Products may not be disassembled, converted, modified, reproduced or otherwise changed without prior written consent of ROHM.
3. In no event shall you use in any way whatsoever the Products and the related technical information contained in the Products or this document for any military purposes, including but not limited to, the development of mass-destruction weapons.
4. The proper names of companies or products described in this document are trademarks or registered trademarks of ROHM, its affiliated companies or third parties.

**General Precaution**

1. Before you use our Products, you are requested to carefully read this document and fully understand its contents. ROHM shall not be in any way responsible or liable for failure, malfunction or accident arising from the use of any ROHM's Products against warning, caution or note contained in this document.
2. All information contained in this document is current as of the issuing date and subject to change without any prior notice. Before purchasing or using ROHM's Products, please confirm the latest information with a ROHM sales representative.
3. The information contained in this document is provided on an "as is" basis and ROHM does not warrant that all information contained in this document is accurate and/or error-free. ROHM shall not be in any way responsible or liable for any damages, expenses or losses incurred by you or third parties resulting from inaccuracy or errors of or concerning such information.



TLR341G - Web Page

Part Number	TLR341G
Package	SSOP6
Unit Quantity	3000
Minimum Package Quantity	3000
Packing Type	Taping
Constitution Materials List	inquiry
RoHS	Yes