 <div style="display: inline-block; margin-left: 20px;"> <p style="margin: 0;">-Preliminary-</p> <h1 style="margin: 0;">AP1159ADSXX</h1> <h2 style="margin: 0;">14V Input / 100mA Low voltage Output LDO Regulator</h2> </div>

1. General Description

The AP1159ADSXX is a low dropout linear regulator with ON/OFF control, which can supply 100mA load current. The IC is an integrated circuit with a silicon monolithic bipolar structure. The output voltage, trimmed with high accuracy, is available from 0.9 to 1.2V in 0.1V steps. The output capacitor is available to use a small 0.47 μ F ceramic capacitor. The over current, thermal and reverse bias protections are integrated, and also the package is small and thin type, SOT23-5. The IC is designed for space saving requirements.

2. Features

- Available to use a small 0.47 μ F ceramic capacitor
- Output Voltage 0.9V, 1.0V, 1.1V, 1.2V
- High Precision output voltage \pm 50mV
- Output Current 100mA
- High ripple rejection ratio 80dB at 1kHz
- Low Output Noise 30 μ V_{RMS}
- Wide operating voltage range 2.1V to 14.0V
- Very low quiescent current I_{QUT}=110 μ A at I_{OUT}=0mA
- Low Standby Current 0.1 μ A
- On/Off control (High active)
- Built-in Short circuit protection, thermal shutdown
- Built-in reverse bias over current protection
- Available very low noise application
- Very small surface mount package SOT23-5

3. Application

- Automotive accessory equipment
- Any Electronic Equipment
- Battery Powered Systems
- Mobile Communication

4. Table of Contents

1. General Description	1
2. Features	1
3. Application.....	1
4. Table of Contents	2
5. Block Diagram	3
6. Ordering Information	3
7. Pin Configurations and Functions.....	4
■ Pin Configurations.....	4
■ Pin Functions	4
8. Absolute Maximum Ratings	5
9. Recommended Operation Conditions	5
10. Electric Characteristics	6
■ Electrical Characteristics of $T_a=T_j=25^{\circ}\text{C}$	6
■ Electrical Characteristics of $T_a=-40^{\circ}\text{C}\sim 85^{\circ}\text{C}$	7
11. Functional Descriptions	8
11.1 DC characteristics.....	8
11.2 DC temperature characteristics.....	10
11.3 Ripple Rejection	11
11.4 Line Transient.....	11
11.5 Load Transient.....	12
11.6 On/Off Transient	13
11.7 Inrush Current.....	13
11.8 Output Noise	14
11.9 Stability.....	15
11.10 Operating Region and Power Dissipation	16
12. Definition of technical terms	17
13. Package	18
■ Outline Dimensions	18
IMPORTANT NOTICE	19

5. Block Diagram

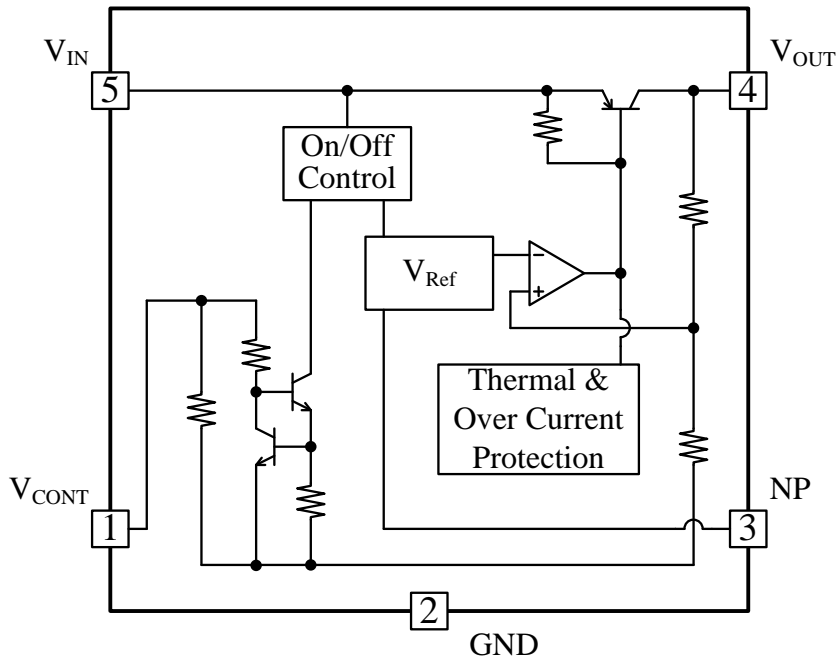

Figure 1. Block Diagram

6. Ordering Information

AP1159ADSXX $T_a = -40$ to 85°C SOT23-5

- Output Voltage Code

For product name, please check the below chart. Please contact your authorized ASAHI KASEI MICRODEVICES representative for voltage availability.

AP1159ADSXX

└─── Output voltage code

Table 1. Standard Voltage Version, Output Voltage & Voltage Code

XX	VOUT	XX	VOUT	XX	VOUT	XX	VOUT
09	0.9	10	1.0	11	1.1	12	1.2

7. Pin Configurations and Functions

■ Pin Configurations

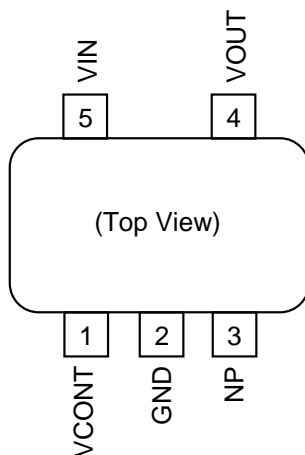

■ Pin Functions

Pin #	Pin Name	Function
1	VCONT	ON/OFF control VCONT > 1.8V : ON VCONT < 0.35V : OFF Internal Pull-down(500kΩ)
2	GND	GND
3	NP	Noise pass Connect noise pass capacitor to GND.
4	VOUT	Output
5	VIN	Input

8. Absolute Maximum Ratings

Parameter	Symbol	min	max	Unit	Condition
Input voltage	V _{INMAX}	-0.4	16	V	
Output bias	V _{REVMAX}	-0.4	6	V	
NP pin voltage	V _{NPMAX}	-0.4	5	V	
Control pin voltage	V _{CONTMAX}	-0.4	16	V	
Junction temperature	T _j	-	150	°C	
Storage temperature	T _{STG}	-55	150	°C	
Power dissipation	P _D	-	400	mW	(Note 1)

Note 1. Ambient temperature is over 25°C, power dissipation decreases by 4.0mW/°C. In case of mounting on 2 layer glass epoxy substrate (3cm×3cm, t=1mm, copper layer t=0.35μm)

WARNING: Operation at or beyond these limits may result in permanent damage to the device. Normal operation is not guaranteed at these extremes.

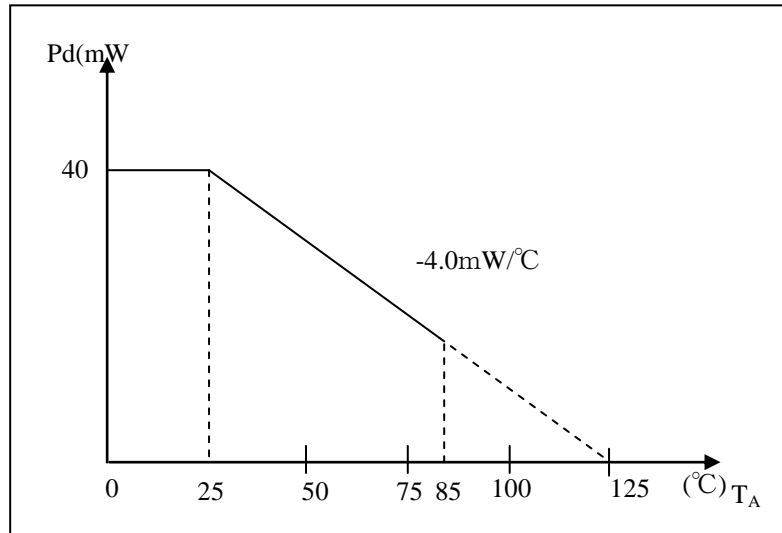

Figure 2. Maximum Power Dissipation

9. Recommended Operation Conditions

Parameter	Symbol	min	typ	max	Unit	Comments
Operational temperature	T _a	-40	-	85	V	
Input voltage	V _{IN}	2.1	-	14	°C	

10. Electric Characteristics

■ **Electrical Characteristics of Ta=Tj=25°C**

The parameters with min or max values will be guaranteed at Ta=Tj=25°C.

(Ta =Tj= 25°C, V_{IN}=2.1V, V_{CONT} = 1.8V, unless otherwise specified)

Parameter	Symbol	Test Conditions	min	typ	Max	Unit
Output voltage	V _{OUT}	I _{OUT} = 5mA	(Table 2)			V
Line regulation	L _{IN} R _{EG}	ΔV _{IN} = 5V	-	0.0	5.0	mV
Load regulation	L _{OA} R _{EG}	I _{OUT} = 5mA ~ 50mA	-	5.0	10.0	mV
		I _{OUT} = 5mA ~ 100mA	-	10.0	22.0	mV
Output current	I _{OUT}		100	-	-	mA
Quiescent Current	I _Q	I _{OUT} = 0mA	-	110	160	μA
Standby current	I _{STANDBY}	V _{CONT} = 0V	-	0.0	0.1	μA
Ground pin current	I _{GND}	I _{OUT} = 50mA	-	1.5	2.7	mA
Control pin						
Control current	I _{CONT}	V _{CONT} = 1.8V	-	5.5	15.0	μA
Control voltage	V _{CONT}	V _{OUT} ON state	1.8	-	-	V
		V _{OUT} OFF state	-	-	0.35	V
Reference value (Note 2)						
Np pin voltage	V _{NP}		-	0.8	-	V
V _{OUT} drift	V _{OUT} /T _A		-	60	-	ppm/°C
Output noise voltage	V _{noise}	C _{OUT} =1.0μF, C _{NP} =0.01μF I _{out} =30mA	-	30	-	μV _{RMS}
Ripple rejection (Note 3)	RR	V _{IN} =2.1V, I _{OUT} =10mA, f=1kHz C _{OUT} =1.0μF, C _{NP} =0.001μF	-	48	-	dB
		V _{IN} =2.3V, I _{OUT} =10mA, f=1kHz C _{OUT} =1.0μF, C _{NP} =0.001μF	-	80	-	dB
Output rising time	tr	C _{OUT} =1.0μF, C _{NP} =0.001μF V _{CONT} : pulse input(100Hz) V _{CONT} ON → V _{out} ×95% point	-	120	-	μs

Note 2. Reference value doesn't guarantee.

Note 3. Ripple rejection is varied by output voltage and external components specifications.

Table 2. Standard Voltage Version

Parameter	Output voltage		
	MIN	TYP	MAX
	V	V	V
AP1159ADS09	0.85	0.9	0.95
AP1159ADS10	0.95	1.0	1.05
AP1159ADS11	1.05	1.1	1.15
AP1159ADS12	1.15	1.2	1.25

■ Electrical Characteristics of Ta=-40°C~85°C

The parameters with min or max values will be guaranteed at Ta=Tj=-40 ~ 85°C.

(Ta =Tj= -40~85°C, V_{IN}=2.1V, V_{CONT} = 1.8V, unless otherwise specified)

Parameter	Symbol	Test Conditions	Min	typ	max	Unit
Output voltage	V _{OUT}	I _{OUT} = 5mA	(Table 3)			V
Line regulation	L _{IN} R _{EG}	ΔV _{IN} = 5V	-	0	8	mV
Load regulation	L _{OA} R _{EG}	I _{OUT} = 5mA ~ 50mA	-	5.0	13.0	mV
		I _{OUT} = 5mA ~ 100mA	-	10.0	28.0	mV
Output current	I _{OUT}		100	-	-	mA
Quiescent Current	I _Q	I _{OUT} = 0mA	-	110	192	μA
Standby current	I _{STANDBY}	V _{CONT} = 0V	-	0	0.5	μA
Ground pin current	I _{GND}	I _{OUT} = 50mA	-	1.5	3.3	mA
Control pin						
Control current	I _{CONT}	V _{CONT} = 1.8V	-	5.5	15.0	μA
Control voltage	V _{CONT}	V _{OUT} ON state	1.8	-	-	V
		V _{OUT} OFF state	-	-	0.35	V
Reference value (Note 4)						
Np pin voltage	V _{NP}		-	0.8	-	V
V _{OUT} drift	V _{OUT} /T _A		-	60	-	ppm/°C
Output noise voltage	V _{noise}	C _{OUT} =1.0μF, C _{NP} =0.01μF I _{out} =30mA	-	30	-	μV _{RMS}
Ripple rejection (Note 5)	RR	V _{IN} =2.1V, I _{OUT} =10mA, f=1kHz	-	48	-	dB
		C _{OUT} =1.0μF, C _{NP} =0.001μF	-	80	-	dB
		V _{IN} =2.3V, I _{OUT} =10mA, f=1kHz	-	80	-	dB
		C _{OUT} =1.0μF, C _{NP} =0.001μF	-	80	-	dB
Output rising time	tr	C _{OUT} =1.0μF, C _{NP} =0.001μF V _{CONT} : pulse input(100Hz) V _{CONT} ON → V _{out} ×95% point	-	120	-	μs

Note 4. Reference value doesn't guarantee.

Note 5. Ripple rejection is varied by output voltage and external components specifications.

Table 3. Standard Voltage Version

Parameter	Output voltage		
	MIN	TYP	MAX
	V	V	V
AP1159ADS09	0.82	0.9	0.98
AP1159ADS10	0.92	1.0	1.08
AP1159ADS11	1.02	1.1	1.18
AP1159ADS12	1.12	1.2	1.28

11. Functional Descriptions

11.1 DC characteristics

■ V_{OUT} VS V_{IN}

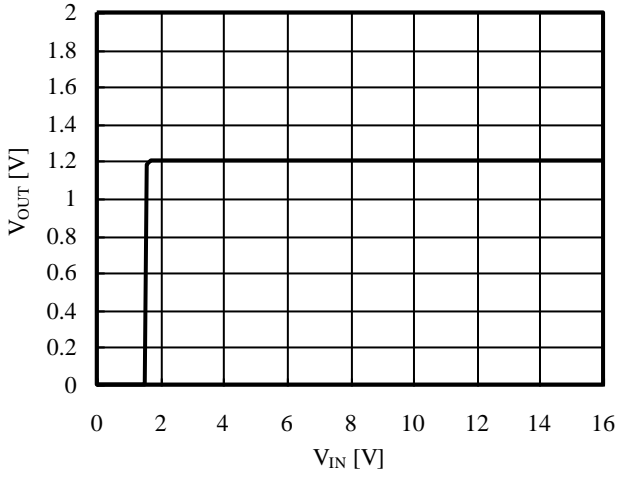

■ V_{NP} VS V_{IN}

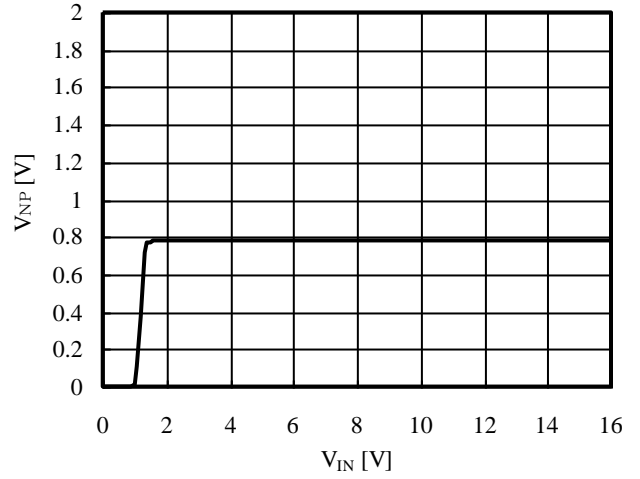

■ Line Regulation

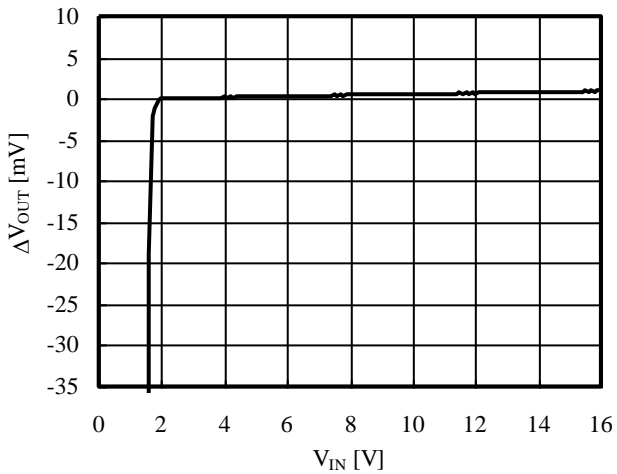

■ Load Regulation

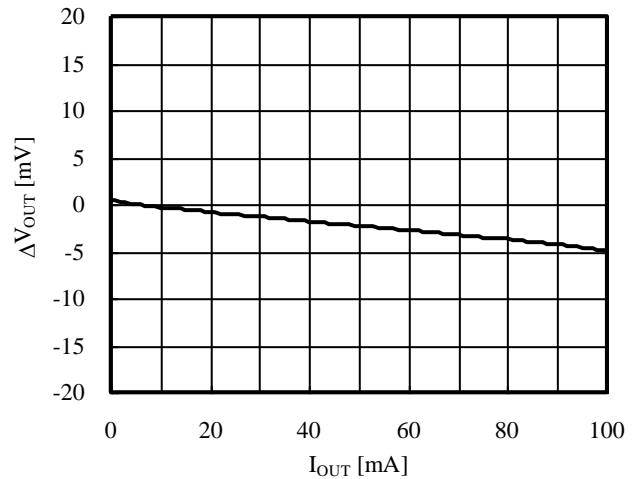

■ Short Circuit Current

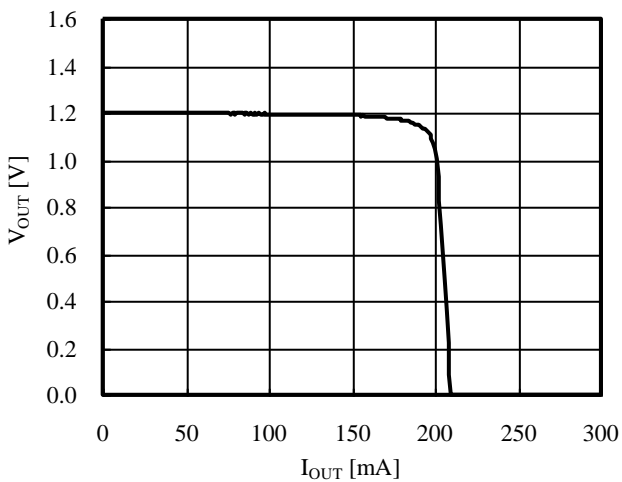

■ Quiescent Current ($I_{OUT}=0V$)

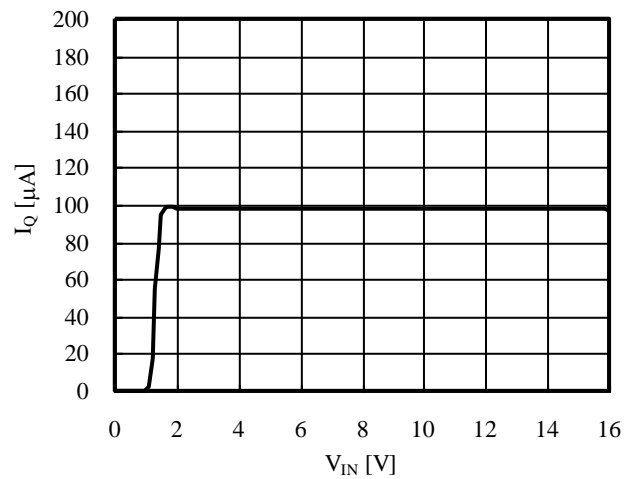

■ Standby Current (VCONT=0V)

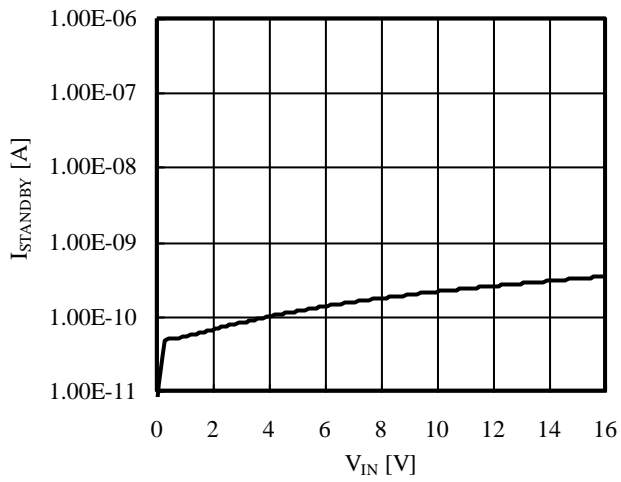

■ GND Pin Current

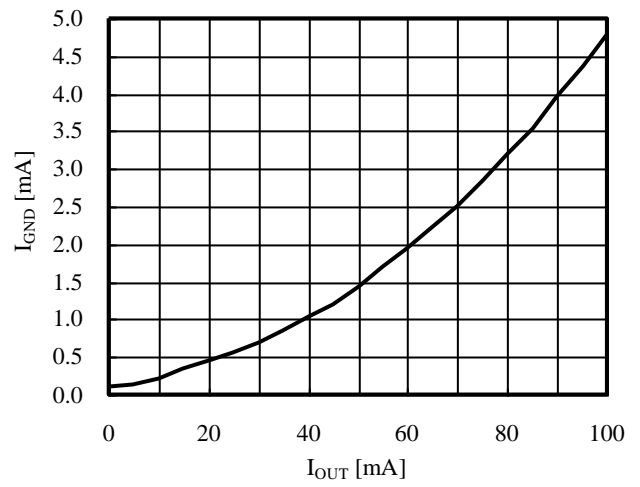

■ Control Current

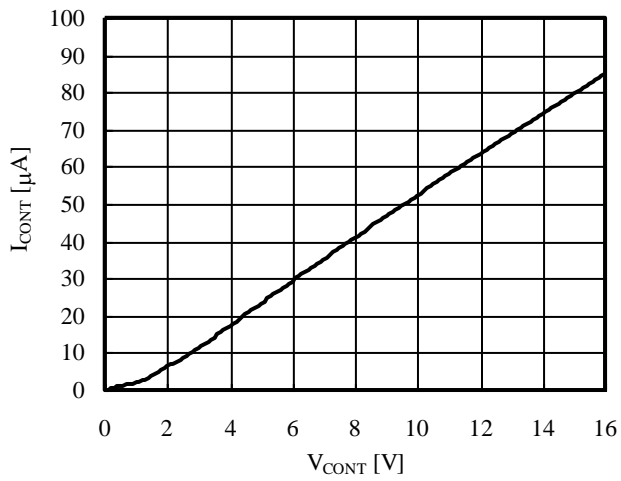

■ VOUT ON/OFF Point

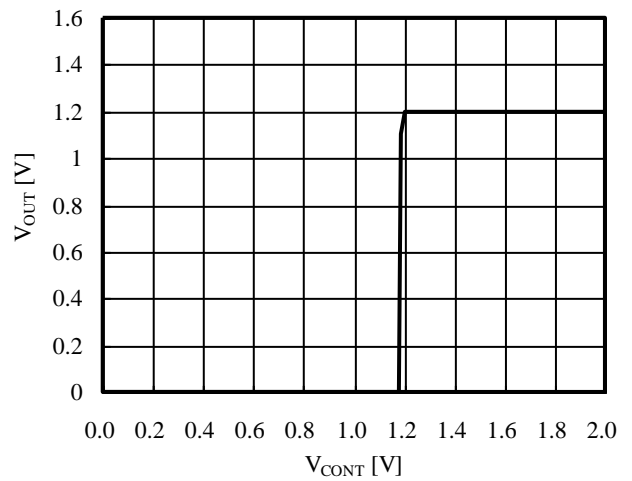

11.2 DC temperature characteristics

■ V_{OUT}

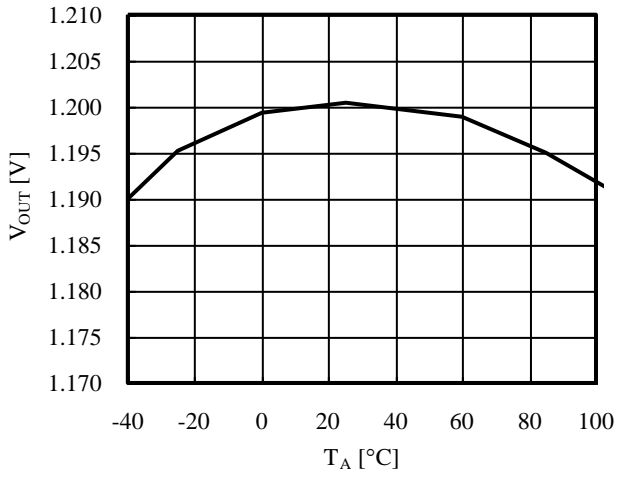

■ Load Regulation

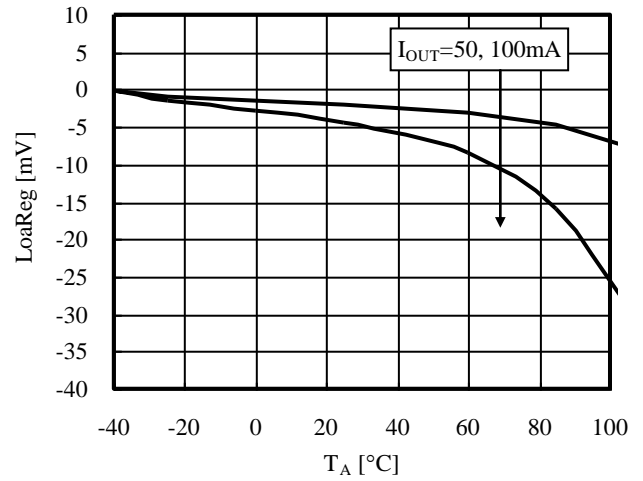

■ Short Circuit Current

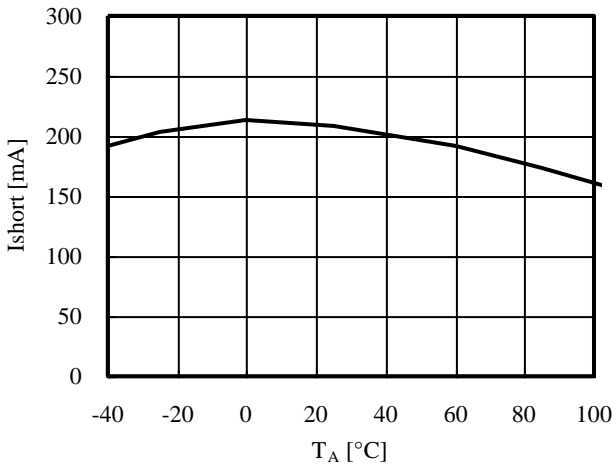

■ Quiescent Current ($I_{OUT}=0V$)

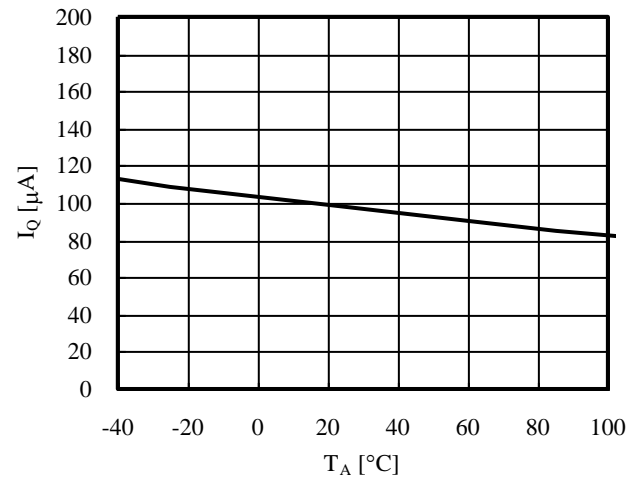

■ GND Pin Current

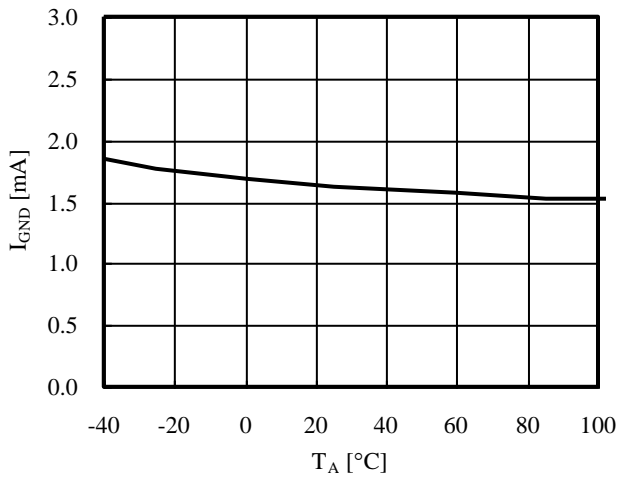

■ Control Current

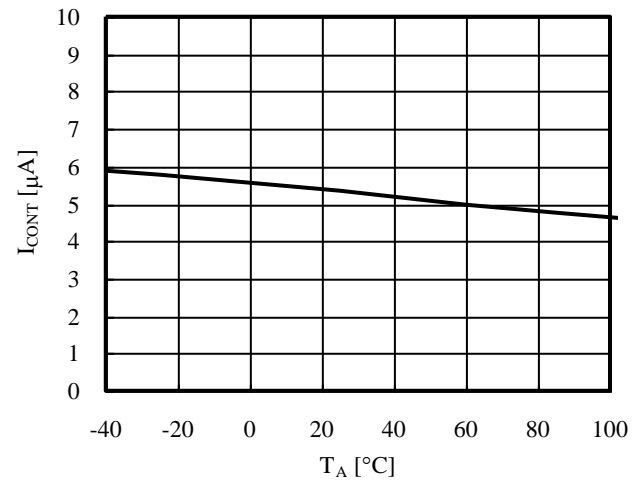

■ V_{OUT} ON/OFF Point

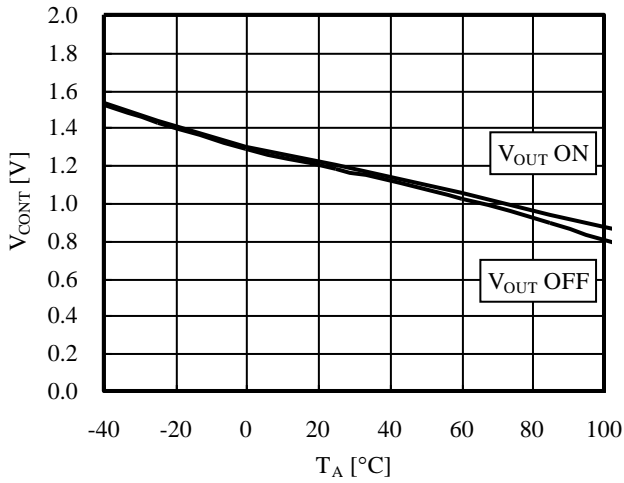

11.3 Ripple Rejection

■ C_{OUT}=0.47, 1.0, 2.2, 4.7, 10 μF

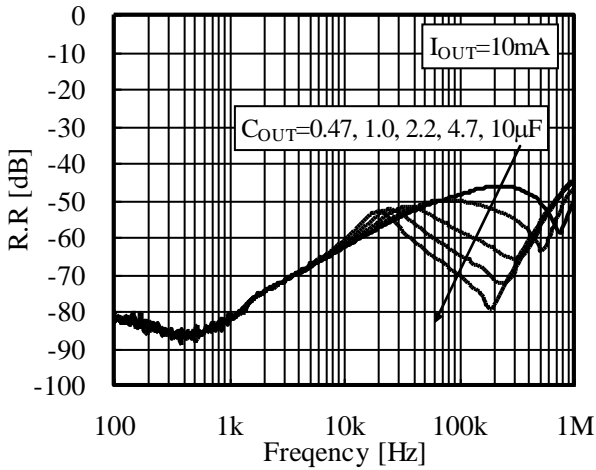

■ R.R vs I_{OUT} (Frequency=1kHz)

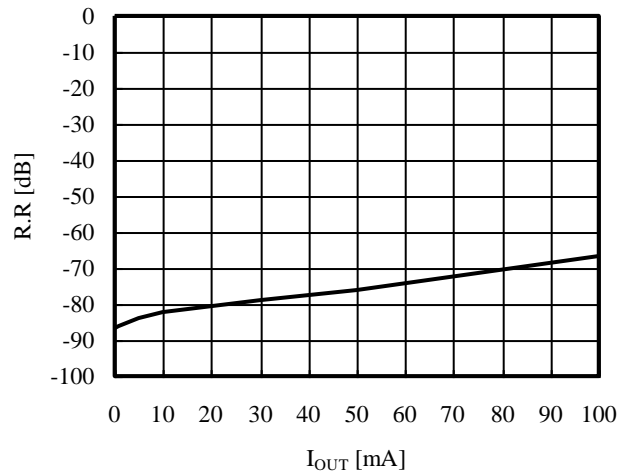

11.4 Line Transient

■ I_{OUT}=1, 30, 100mA

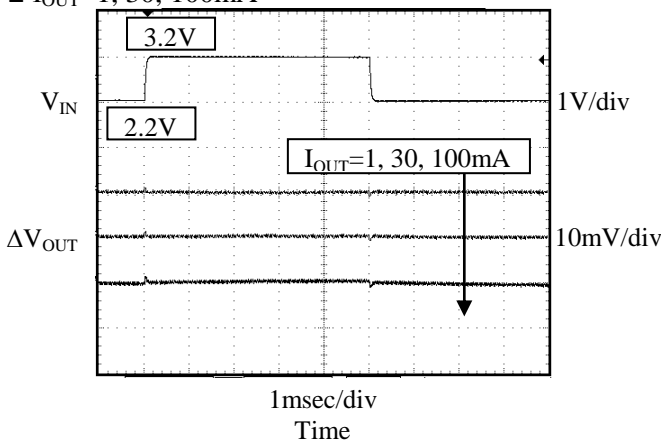

■ C_{OUT}=10, 4.7, 2.2, 1.0, 0.47 μF (I_{OUT}=1mA)

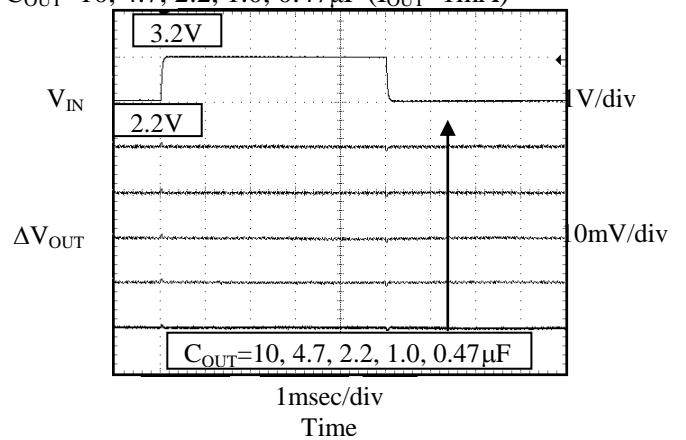

11.5 Load Transient

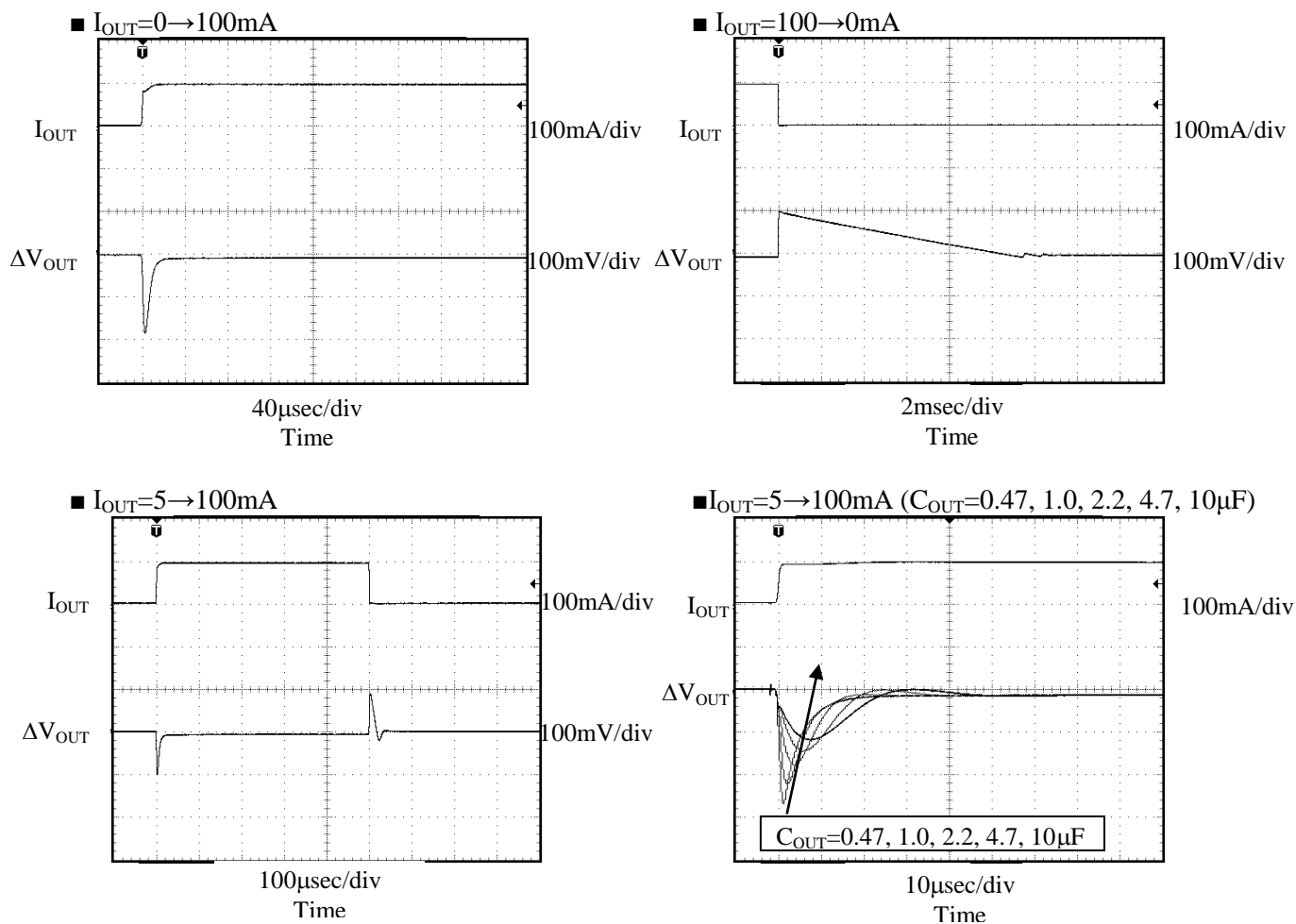

11.6 On/Off Transient

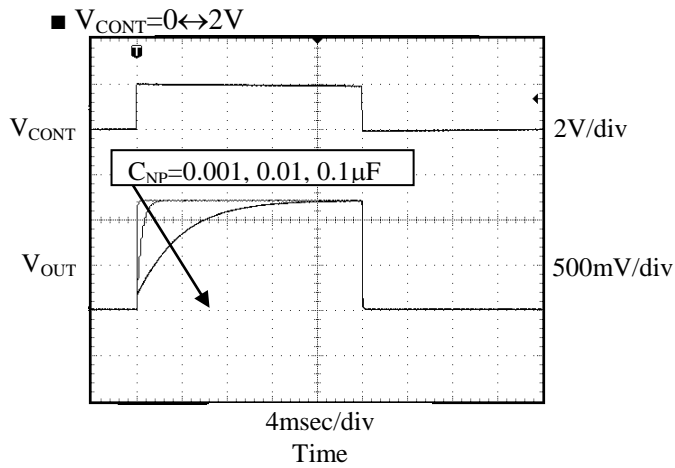
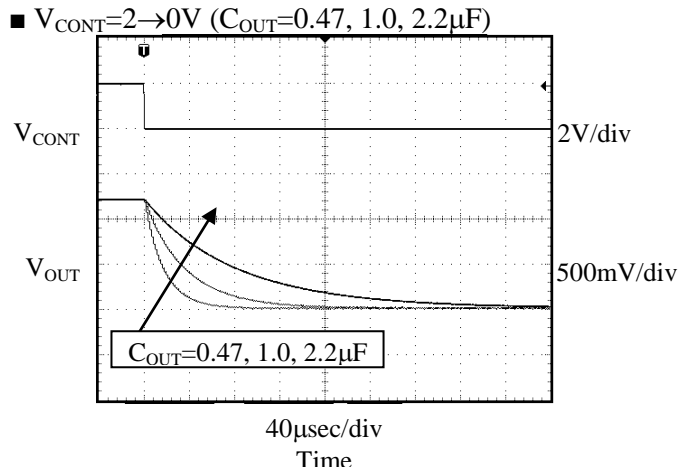
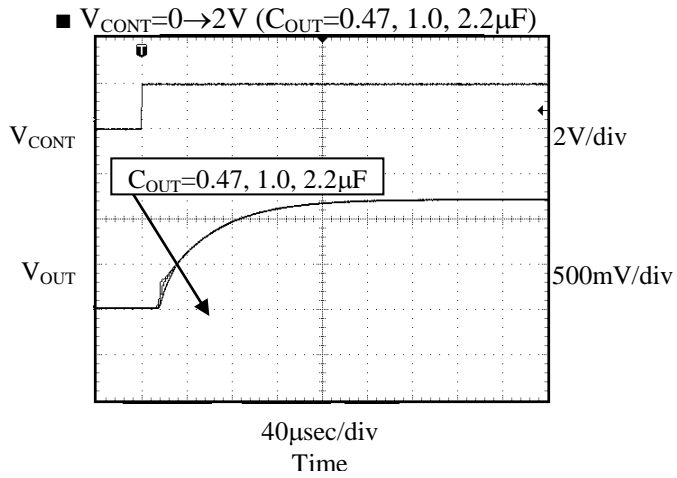

11.7 Inrush Current

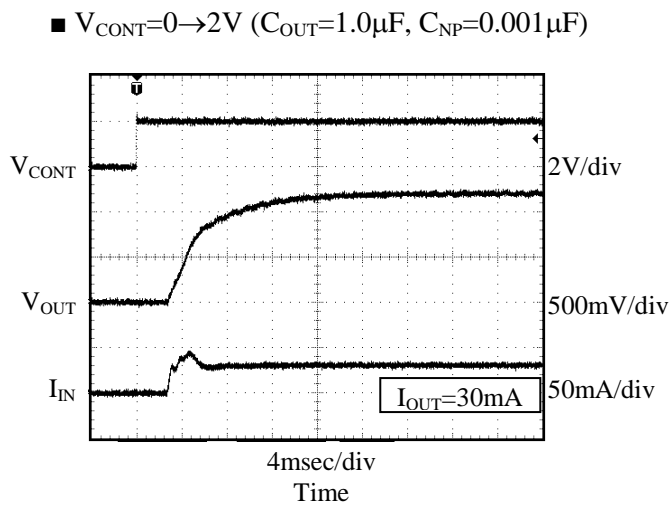

■ InRush Current vs C_{NP}

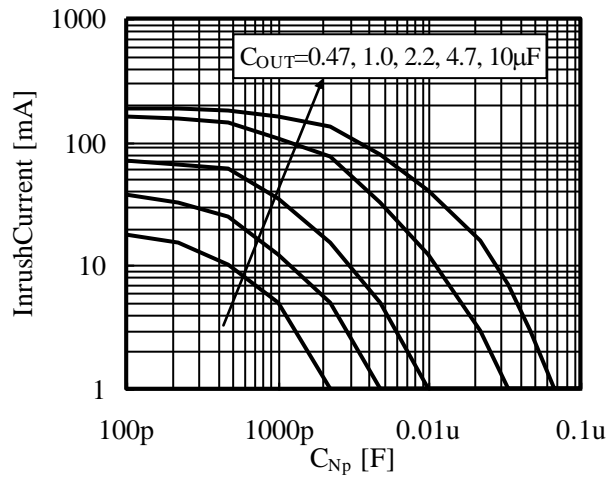

11.8 Output Noise

■ Noise vs I_{OUT} (BPF=100Hz~80kHz)

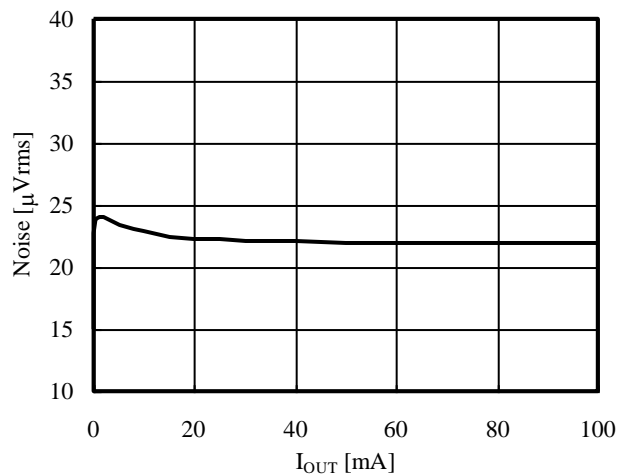

■ Noise vs C_{NP} (BPF=100Hz~80kHz)

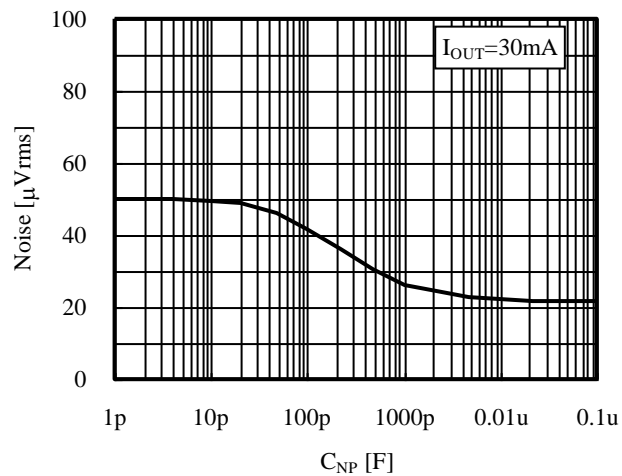

■ Noise vs Frequency

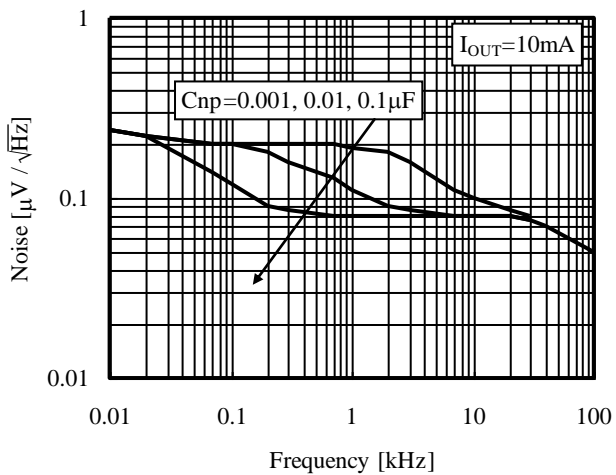

11.9 Stability

Linear regulators require input and output capacitors in order to maintain the regulator's loop stability. If 0.47 μ F or larger capacitor is connected to the output side, the IC provides stable operation at any voltage ($0.9V \leq V_{out_TYP} \leq 1.2V$). (The capacitor must be larger than 0.47 μ F at all temperature and voltage range) If the capacitor with high Equivalent Series Resistance (ESR) (several ohms) is used, such as tantalum capacitor etc., the regulator may oscillate. Please select parts with low ESR. Due to the parts are uneven, please enlarge the capacitance as much as possible. With larger capacity, the output noise decreases more. In addition, the response to the load change, etc. can be improved. The IC won't be damaged by enlarging the capacity. A recommended value of the application is as follows.

Measurement circuit

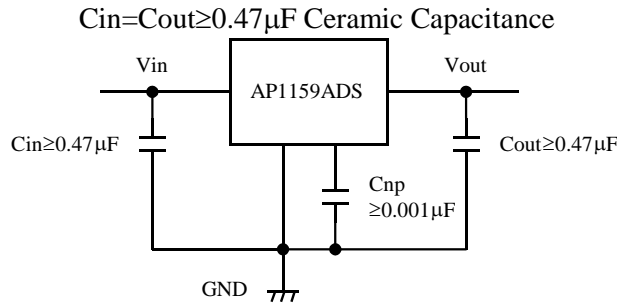

Output Voltage, Output Current vs. Stable Operation Area

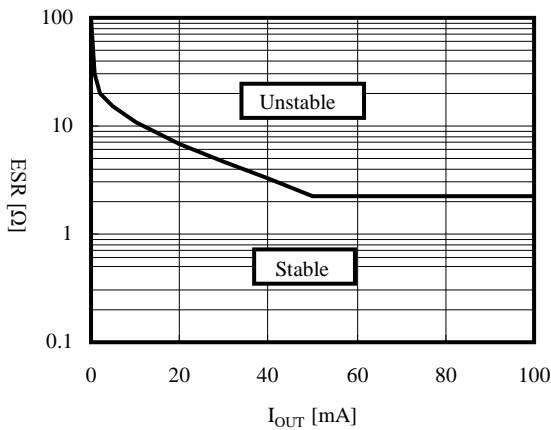

Figure 3. $C_{out} = 0.47\mu F$

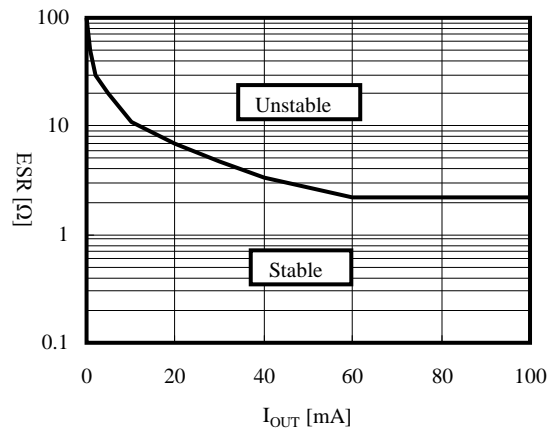

Figure 4. $C_{out} = 0.68\mu F$

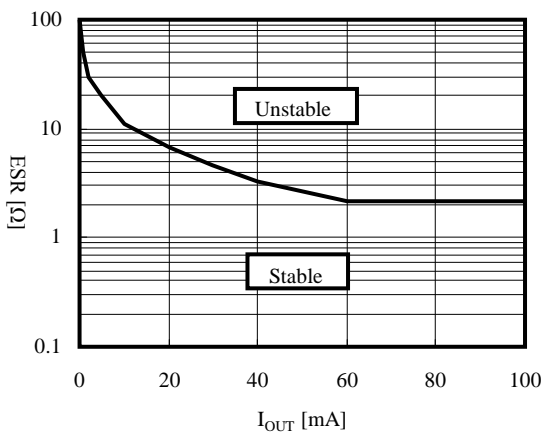

Figure 5. $C_{OUT} = 1.0\mu F$

Generally, a ceramic capacitor has both temperature characteristic and voltage characteristic. Please consider both characteristics when selecting the part. The B curves are the recommend characteristics.

11.10 Operating Region and Power Dissipation

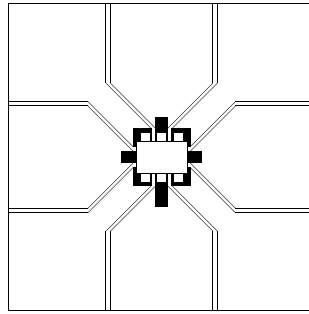

Figure 6. PCB Material: Glass epoxy (t=1.0mm)

Please do derating with 4.0mW/°C at Pd=400mW and 25°C or more. Thermal resistance (θ_{ja}) is=250°C/W. The package loss is limited at the temperature that the internal temperature sensor works (about 150°C). Therefore, the package loss is assumed to be an internal limitation. There is no heat radiation characteristic of the package unit assumed because of the small size. The device being mounted on the PCB carries heat away. This value changes by the material and the copper pattern etc. of the PCB. The losses are approximately 400mW. Enduring these losses becomes possible in a lot of applications operating at 25°C.

The overheating protection circuit operates when there are a lot of losses with the regulator (When outside temperature is high or heat radiation is bad). The output current cannot be pulled enough and the output voltage will drop when the protection circuit operates. When the junction temperature reaches 150°C, the IC is shut down. However, operation begins at once when the IC stops operation and the temperature of the chip decreases.

How to determine the thermal resistance when mounted on PCB

The thermal resistance when mounted is expressed as follows:

$$T_j = \theta_{ja} \times P_d + T_a$$

T_j of IC is set around 150°C. P_d is the value when the thermal sensor is activated.

If the ambient temperature is 25°C, then:

$$150 = \theta_{ja} \times P_d + 25$$

$$\theta_{ja} = 125 / P_d \text{ (}^\circ\text{C / mW)}$$

Noise bypass capacitor

The noise and the ripple rejection characteristics depend on the capacitance on the Np terminal.

The ripple rejection characteristic of the low frequency region improves by increasing the capacitance of Cnp. A standard value is Cnp=0.001μF. Increase Cnp in a design with important output noise and ripple rejection requirements. The IC will not be damaged if the capacitor value is increased.

The on/off switching speed changes depending on the Np terminal capacitance. The switching speed slows when the capacitance is large.

12. Definition of technical terms

■ Relating Characteristic

• Output Voltage (Vout)

The output voltage is specified with $V_{in}=(V_{out_TYP}+1V)$ and $I_{out}=5mA$.

• Maximum Output Current (Iout MAX)

The rated output current is specified under the condition where the output voltage drops 0.3V the value specified with $I_{out}=5mA$. The input voltage is set to $V_{out_TYP}+1V$ and the current is pulsed to minimize temperature effect.

• Dropout Voltage (Vdrop)

The dropout voltage is the difference between the input voltage and the output voltage at which point the regulator starts to fall out of regulation. Below this value, the output voltage will fall as the input voltage is reduced. It is dependent upon the load current and the junction temperature.

• Line Regulation (LinReg)

Line regulation is the ability of the regulator to maintain a constant output voltage as the input voltage changes. The line regulation is specified as the input voltage is changed from $V_{in}=V_{out_TYP}+1V$ to $V_{in}=V_{out_TYP}+6V$. It is a pulse measurement to minimize temperature effect.

• Load Regulation (LoaReg)

Load regulation is the ability of the regulator to maintain a constant output voltage as the load current changes. It is a pulsed measurement to minimize temperature effects with the input voltage set to $V_{in}=V_{out_TYP}+1V$. The load regulation is specified output current step conditions of 5mA to 100mA.

• Ripple Rejection (R.R)

Ripple rejection is the ability of the regulator to attenuate the ripple content of the input voltage at the output. It is specified with $200mV_{rms}$, 1kHz super-imposed on the input voltage, where $V_{in}=V_{out}+1.5V$. Ripple rejection is the ratio of the ripple content of the output vs. input and is expressed in dB.

• Standby Current (Istandby)

Standby current is the current, which flows into the regulator when the output is turned off by the control function ($V_{cont}=0V$).

■ Relating Protection Circuit

• Over Current Sensor

The over current sensor protects the device when there is excessive output current. It also protects the device if the output is accidentally connected to ground.

• Thermal Sensor

The thermal sensor protects the device in case the junction temperature exceeds the safe value ($T_j=150^{\circ}C$). This temperature rise can be caused by external heat, excessive power dissipation caused by large input to output voltage drops, or excessive output current. The regulator will shut off when the temperature exceeds the safe value. As the junction temperatures decrease, the regulator will begin to operate again. Under sustained fault conditions, the regulator output will oscillate as the device turns off then resets. Damage may occur to the device under extreme fault.

Please reduce the loss of the regulator when this protection operate, by reducing the input voltage or make better heat efficiency.

In the case that the power, $V_{in} \times I_{short}$ (Short Circuit Current), becomes more than twice of the maximum rating of its power dissipation in a moment, there is a possibility that the IC is destroyed before internal thermal protection works.

• Reverse Voltage Protection

Reverse voltage protection prevents damage due to the output voltage being higher than the input voltage. This fault condition can occur when the output capacitor remains charged and the input is reduced to zero, or when an external voltage higher than the input voltage is applied to the output side

• ESD

MM: 200pF 0Ω 200V or more

HBM: 100pF 1.5kΩ 2000V or more

13. Package

■ Outline Dimensions

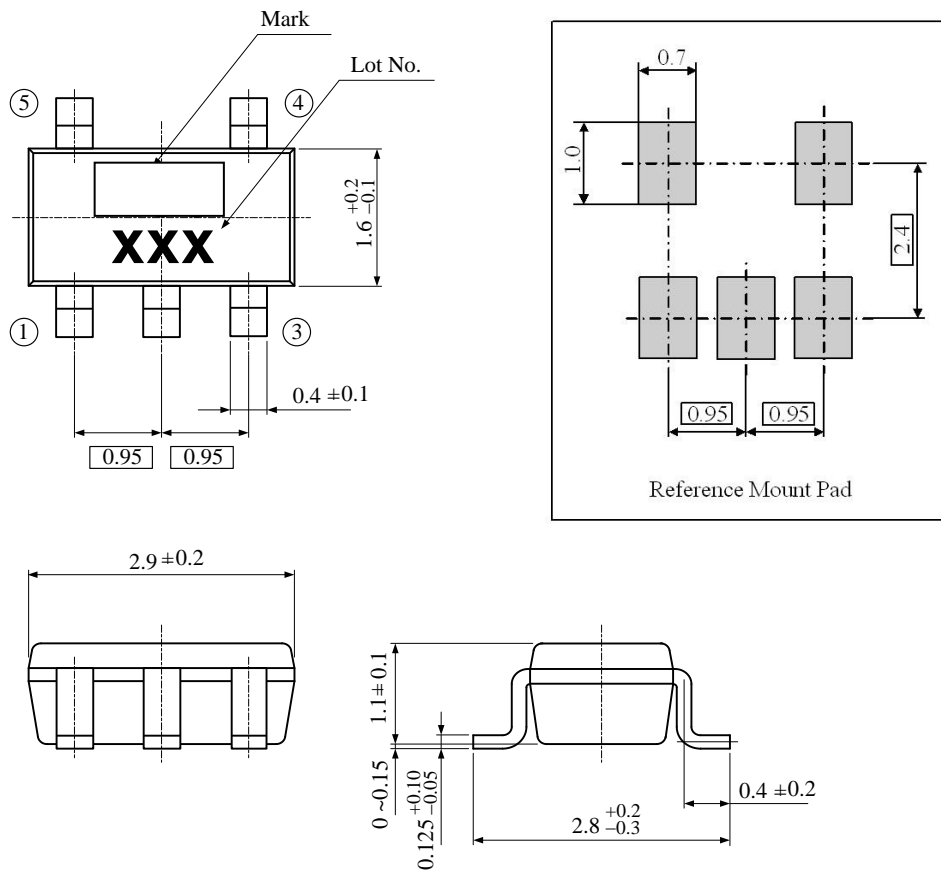

IMPORTANT NOTICE

0. Asahi Kasei Microdevices Corporation (“AKM”) reserves the right to make changes to the information contained in this document without notice. When you consider any use or application of AKM product stipulated in this document (“Product”), please make inquiries the sales office of AKM or authorized distributors as to current status of the Products.
1. All information included in this document are provided only to illustrate the operation and application examples of AKM Products. AKM neither makes warranties or representations with respect to the accuracy or completeness of the information contained in this document nor grants any license to any intellectual property rights or any other rights of AKM or any third party with respect to the information in this document. You are fully responsible for use of such information contained in this document in your product design or applications. **AKM ASSUMES NO LIABILITY FOR ANY LOSSES INCURRED BY YOU OR THIRD PARTIES ARISING FROM THE USE OF SUCH INFORMATION IN YOUR PRODUCT DESIGN OR APPLICATIONS.**
2. The Product is neither intended nor warranted for use in equipment or systems that require extraordinarily high levels of quality and/or reliability and/or a malfunction or failure of which may cause loss of human life, bodily injury, serious property damage or serious public impact, including but not limited to, equipment used in nuclear facilities, equipment used in the aerospace industry, medical equipment, equipment used for automobiles, trains, ships and other transportation, traffic signaling equipment, equipment used to control combustions or explosions, safety devices, elevators and escalators, devices related to electric power, and equipment used in finance-related fields. Do not use Product for the above use unless specifically agreed by AKM in writing.
3. Though AKM works continually to improve the Product’s quality and reliability, you are responsible for complying with safety standards and for providing adequate designs and safeguards for your hardware, software and systems which minimize risk and avoid situations in which a malfunction or failure of the Product could cause loss of human life, bodily injury or damage to property, including data loss or corruption.
4. Do not use or otherwise make available the Product or related technology or any information contained in this document for any military purposes, including without limitation, for the design, development, use, stockpiling or manufacturing of nuclear, chemical, or biological weapons or missile technology products (mass destruction weapons). When exporting the Products or related technology or any information contained in this document, you should comply with the applicable export control laws and regulations and follow the procedures required by such laws and regulations. The Products and related technology may not be used for or incorporated into any products or systems whose manufacture, use, or sale is prohibited under any applicable domestic or foreign laws or regulations.
5. Please contact AKM sales representative for details as to environmental matters such as the RoHS compatibility of the Product. Please use the Product in compliance with all applicable laws and regulations that regulate the inclusion or use of controlled substances, including without limitation, the EU RoHS Directive. AKM assumes no liability for damages or losses occurring as a result of noncompliance with applicable laws and regulations.
6. Resale of the Product with provisions different from the statement and/or technical features set forth in this document shall immediately void any warranty granted by AKM for the Product and shall not create or extend in any manner whatsoever, any liability of AKM.
7. This document may not be reproduced or duplicated, in any form, in whole or in part, without prior written consent of AKM.