

General Description

The MDD5N50Z uses advanced Magnachip's MOSFET Technology, which provides low on-state resistance, high switching performance and excellent quality.

MDD5N50Z is suitable device for SMPS, HID and general purpose applications.

Features

- $V_{DS} = 500V$
- $V_{DS} = 550V$ @ T_{jmax}
- $I_D = 4.4A$ @ $V_{GS} = 10V$
- $R_{DS(ON)} \leq 1.4\Omega$ @ $V_{GS} = 10V$

Applications

- Power Supply
- PFC
- Ballast

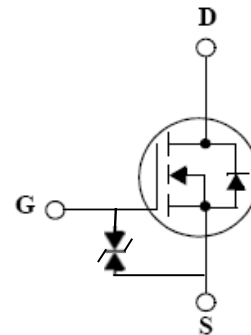
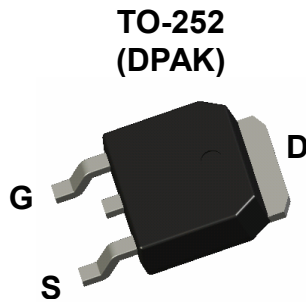

Absolute Maximum Ratings (Ta = 25°C)

Characteristics	Symbol	Rating	Unit
Drain-Source Voltage	V_{DSS}	500	V
Drain-Source Voltage @ T_{jmax}	$V_{DSS} @ T_{jmax}$	550	V
Gate-Source Voltage	V_{GSS}	±30	V
Continuous Drain Current	I_D	$T_C=25^\circ C$	4.4 A
		$T_C=100^\circ C$	2.8 A
Pulsed Drain Current ⁽¹⁾	I_{DM}	17.6	A
Power Dissipation	P_D	$T_C=25^\circ C$	70 W
		Derate above 25 °C	0.56 W/°C
Peak Diode Recovery dv/dt ⁽³⁾	Dv/dt	4.5	V/ns
Single Pulse Avalanche Energy ⁽⁴⁾	E_{AS}	230	mJ
Junction and Storage Temperature Range	T_J, T_{stg}	-55~150	°C

Thermal Characteristics

Characteristics	Symbol	Rating	Unit
Thermal Resistance, Junction-to-Ambient ⁽¹⁾	$R_{\theta JA}$	62.5	°C/W
Thermal Resistance, Junction-to-Case ⁽¹⁾	$R_{\theta JC}$	1.8	

Ordering Information

Part Number	Temp. Range	Package	Packing	RoHS Status
MDD5N50ZRH	-55~150°C	DPAK	Reel	Halogen Free

Electrical Characteristics (Ta =25°C)

Characteristics	Symbol	Test Condition	Min	Typ	Max	Unit
Static Characteristics						
Drain-Source Breakdown Voltage	BV_{DSS}	$I_D = 250\mu A, V_{GS} = 0V$	500	-	-	V
Gate Threshold Voltage	$V_{GS(th)}$	$V_{DS} = V_{GS}, I_D = 250\mu A$	3.0	-	5.0	
Drain Cut-Off Current	I_{DSS}	$V_{DS} = 500V, V_{GS} = 0V$	-	-	1	μA
Gate Leakage Current	I_{GSS}	$V_{GS} = \pm 20V, V_{DS} = 0V$	-	-	10	μA
Drain-Source ON Resistance	$R_{DS(on)}$	$V_{GS} = 10V, I_D = 2.2A$		1.15	1.4	Ω
Forward Transconductance	g_{fs}	$V_{DS} = 30V, I_D = 2.2A$	-	5	-	S
Dynamic Characteristics						
Total Gate Charge	Q_g	$V_{DS} = 400V, I_D = 5.0A, V_{GS} = 10V^{(3)}$	-	12.2	16	nC
Gate-Source Charge	Q_{gs}		-	3.6	5	
Gate-Drain Charge	Q_{gd}		-	4.7	6.5	
Input Capacitance	C_{iss}	$V_{DS} = 25V, V_{GS} = 0V, f = 1.0MHz$	-	500	650	pF
Reverse Transfer Capacitance	C_{rss}		-	3	4.0	
Output Capacitance	C_{oss}		-	65	85	
Turn-On Delay Time	$t_{d(on)}$	$V_{GS} = 10V, V_{DS} = 250V, I_D = 5.0A, R_G = 25\Omega^{(3)}$	-	12	35	ns
Rise Time	t_r		-	24	60	
Turn-Off Delay Time	$t_{d(off)}$		-	24	60	
Fall Time	t_f		-	22	55	
Drain-Source Body Diode Characteristics						
Maximum Continuous Drain to Source Diode Forward Current	I_S	$I_S = 4.4A, V_{GS} = 0V$	-	4.4	-	A
Source-Drain Diode Forward Voltage	V_{SD}		-		1.4	V
Body Diode Reverse Recovery Time	t_{rr}	$I_F = 5.0A, di/dt = 100A/\mu s^{(3)}$	-	270		ns
Body Diode Reverse Recovery Charge	Q_{rr}		-	1.8		μC

Note :

- Pulse width is based on $R_{\theta JC}$ & $R_{\theta JA}$ and the maximum allowed junction temperature of 150°C.
- Pulse test: pulse width $\leq 300\mu s$, duty cycle $\leq 2\%$, pulse width limited by junction temperature $T_J(MAX)=150^\circ C$.
- $I_{SD} \leq 5.0A$, $di/dt \leq 200A/\mu s$, $V_{DD}=50V$, $R_g = 25\Omega$, Starting $T_J=25^\circ C$
- $L=16.5mH$, $I_{AS}=5.0A$, $V_{DD}=50V$, $R_g = 25\Omega$, Starting $T_J=25^\circ C$

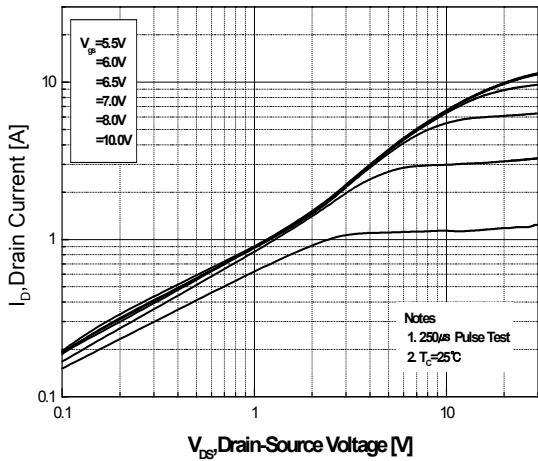

Fig.1 On-Region Characteristics

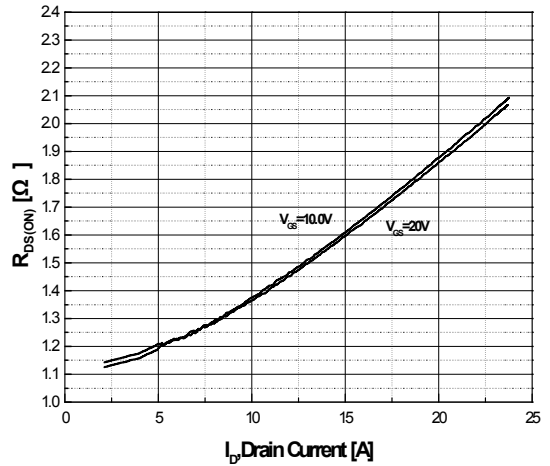

Fig.2 On-Resistance Variation with Drain Current and Gate Voltage

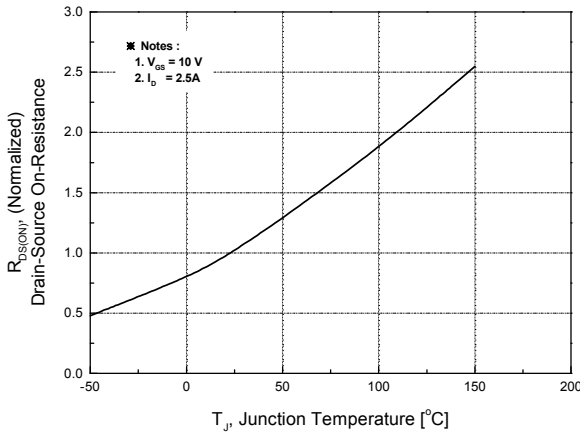

Fig.3 On-Resistance Variation with Temperature

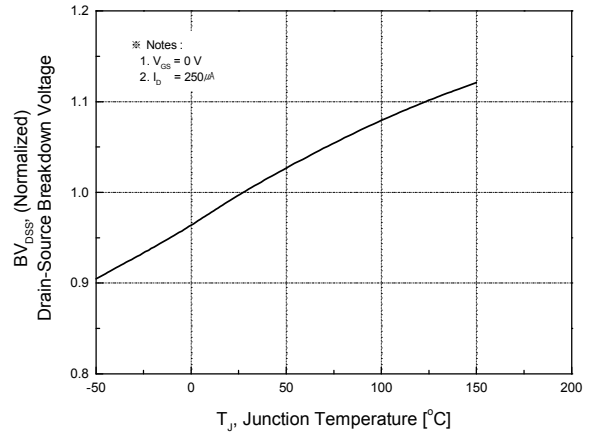

Fig.4 Breakdown Voltage Variation vs. Temperature

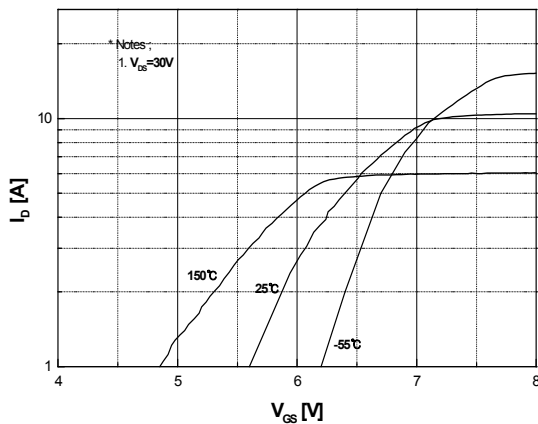

Fig.5 Transfer Characteristics

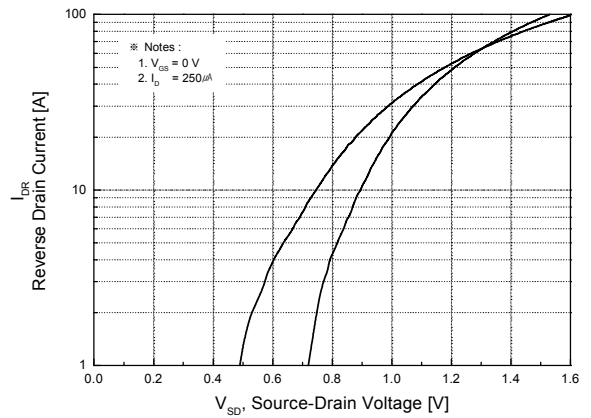

Fig.6 Body Diode Forward Voltage Variation with Source Current and Temperature

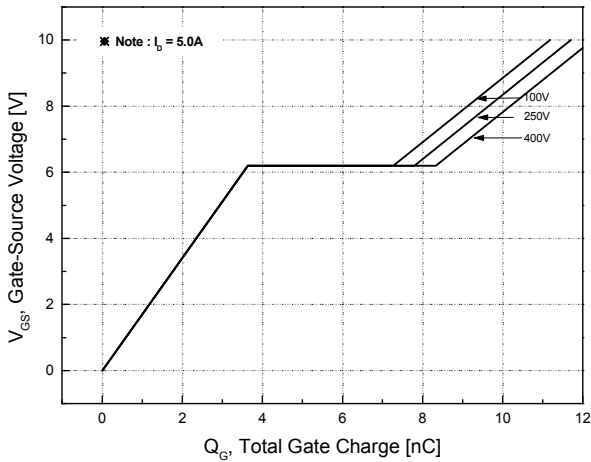

Fig.7 Gate Charge Characteristics

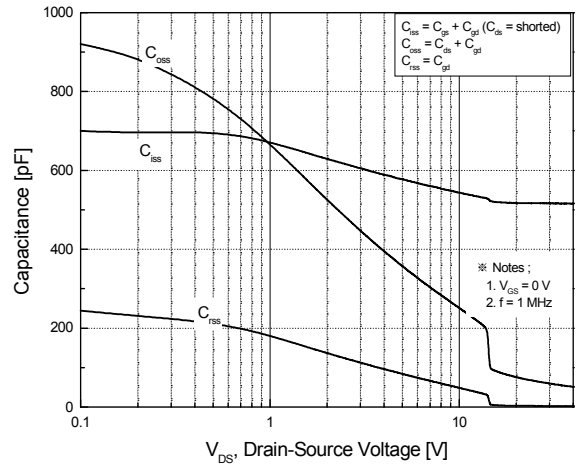

Fig.8 Capacitance Characteristics

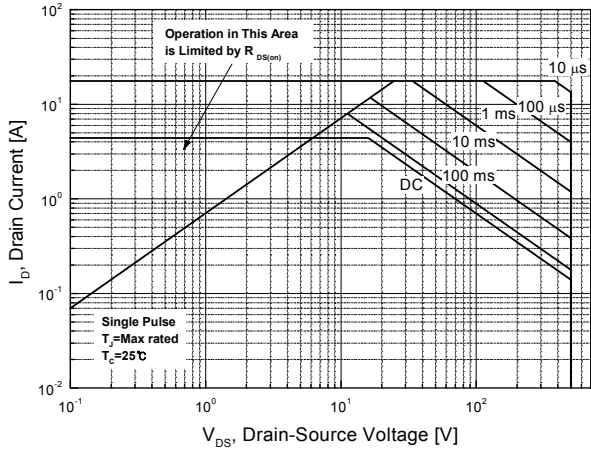

Fig.9 Maximum Safe Operating Area

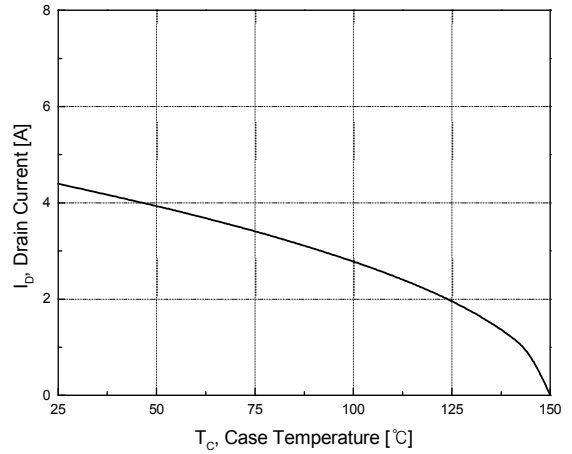

Fig.10 Maximum Drain Current vs. Case Temperature

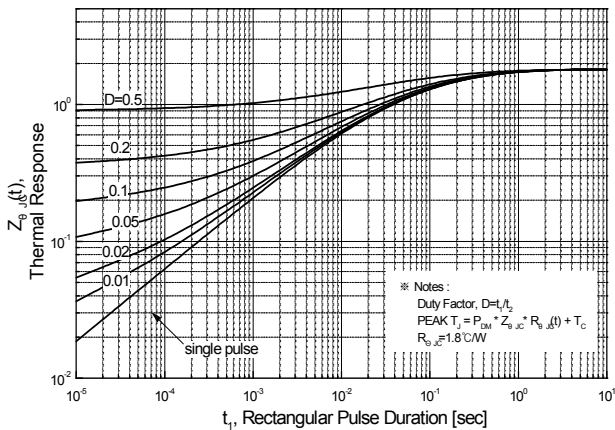

Fig.11 Transient Thermal Response Curve

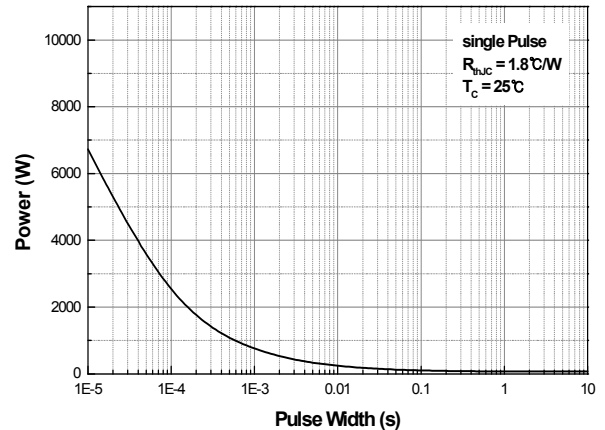
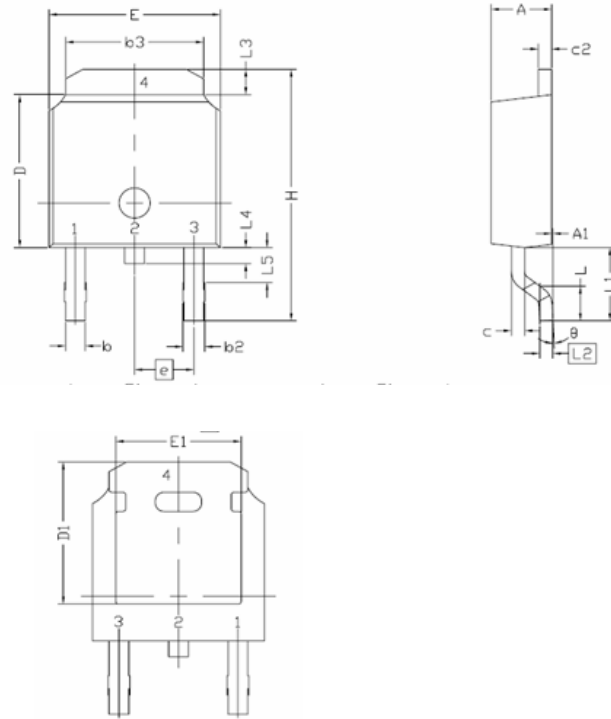

Fig.12 Single Pulse Maximum Power Dissipation

Physical Dimension

D- pak , 3L

Dimensions are in millimeters, unless otherwise specified



Symbol	Min.	Nom.	Max.
E	6.35	-	6.73
L	1.40	1.52	1.78
L1	2.74 REF		
L2	0.508 BCS		
L3	0.89	-	1.27
L4	-	-	1.02
L5	1.14	-	1.52
D	5.97	6.10	6.22
H	9.40	-	10.41
b	0.64	-	0.89
b2	0.76	-	1.14
b3	4.95	-	5.46
e	2.286 BSC		
A	2.18	-	2.39
A1	-	-	0.13
c	0.46	-	0.61
c2	0.46	-	0.89
D1	5.21	-	-
E1	4.32	-	-
⌀	0.00	-	10.00

Worldwide Sales Support Locations

U.S.A**Sunnyvale Office**

787 N. Mary Ave. Sunnyvale
 CA 94085 U.S.A
 Tel : 1-408-636-5200
 Fax : 1-408-213-2450
 E-Mail : usasales@magnachip.com

U.K

Knyvett House The Causeway,
 Staines Middx, TW18 3BA, U.K.
 Tel : +44 (0) 1784-895-000
 Fax : +44 (0) 1784-895-115
 E-Mail : uksales@magnachip.com

Japan**Osaka Office**

3F, Shin-Osaka MT-2 Bldg 3-5-36
 Miyahara Yodogawa-Ku
 Osaka, 532-0003 Japan
 Tel : 81-6-6394-9160
 Fax : 81-6-6394-9150
 E-Mail : osakasales@magnachip.com

Taiwan R.O.C

2F, No.61, Chowize Street, Nei Hu
 Taipei, 114 Taiwan R.O.C
 Tel : 886-2-2657-7898
 Fax : 886-2-2657-8751
 E-Mail : taiwansales@magnachip.com

China**Hong Kong Office**

Suite 1024, Ocean Centre 5 Canton Road,
 Tsim Sha Tsui Kowloon, Hong Kong
 Tel : 852-2828-9700
 Fax : 852-2802-8183
 E-Mail : chinasales@magnachip.com

Shenzhen Office

Room 2003B, 20/F
 International Chamber of Commerce Tower
 Fuhua Road3 CBD, Futian District, China
 Tel : 86-755-8831-5561
 Fax : 86-755-8831-5565
 E-Mail : chinasales@magnachip.com

Shanghai Office

Room E, 8/F, Liaoshen International Building 1068
 Wuzhong Road, (C) 201103
 Shanghai, China
 Tel : 86-21-6405-1521
 Fax : 86-21-6505-1523
 E-Mail : chinasales@magnachip.com

Korea

891, Daechi-Dong, Kangnam-Gu
 Seoul, 135-738 Korea
 Tel : 82-2-6903-3451
 Fax : 82-2-6903-3668 ~9
 Email : koreasales@magnachip.com

DISCLAIMER:

The Products are not designed for use in hostile environments, including, without limitation, aircraft, nuclear power generation, medical appliances, and devices or systems in which malfunction of any Product can reasonably be expected to result in a personal injury. Seller's customers using or selling Seller's products for use in such applications do so at their own risk and agree to fully defend and indemnify Seller.

MagnaChip reserves the right to change the specifications and circuitry without notice at any time. MagnaChip does not consider responsibility for use of any circuitry other than circuitry entirely included in a MagnaChip product.  is a registered trademark of MagnaChip Semiconductor Ltd.