

P-Channel Logic Level Enhancement Mode Field Effect Transistor

Product Summary:

BV _{DSS}	-30V
R _{DS(on)} (MAX.)	44mΩ
I _D	-4A

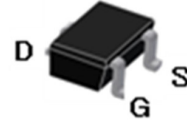
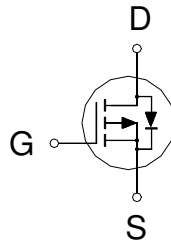

Pb-Free Lead Plating & Halogen Free



ABSOLUTE MAXIMUM RATINGS (T_A = 25 °C Unless Otherwise Noted)

PARAMETERS/TEST CONDITIONS		SYMBOL	LIMITS	UNIT
Gate-Source Voltage		V _{GS}	±12	V
Continuous Drain Current	T _A = 25 °C	I _D	-4	A
	T _A = 70 °C		-3	
Pulsed Drain Current ¹		I _{DM}	-16	
Power Dissipation	T _A = 25 °C	P _D	1.25	W
	T _A = 70 °C		0.8	
Operating Junction & Storage Temperature Range		T _J , T _{stg}	-55 to 150	°C

THERMAL RESISTANCE RATINGS

THERMAL RESISTANCE	SYMBOL	TYPICAL	MAXIMUM	UNIT
Junction-to-Ambient ³	R _{θJA}		100	°C / W
Junction-to-Lead ⁴	R _{θJL}		55	

¹Pulse width limited by maximum junction temperature.

²Duty cycle ≤ 1%

³100°C / W when mounted on a 1 in² pad of 2 oz copper.

⁴ R_{θJA} is the sum of the thermal impedance from junction to lead R_{θJL} and lead to ambient.

ELECTRICAL CHARACTERISTICS ($T_J = 25\text{ }^\circ\text{C}$, Unless Otherwise Noted)

PARAMETER	SYMBOL	TEST CONDITIONS	LIMITS			UNIT
			MIN	TYP	MAX	
STATIC						
Drain-Source Breakdown Voltage	$V_{(BR)DSS}$	$V_{GS} = 0V, I_D = -250\mu A$	-30			V
Gate Threshold Voltage	$V_{GS(th)}$	$V_{DS} = V_{GS}, I_D = -250\mu A$	-0.3	-0.75	-1.2	
Gate-Body Leakage	I_{GSS}	$V_{DS} = 0V, V_{GS} = \pm 12V$			± 100	nA
Zero Gate Voltage Drain Current	I_{DSS}	$V_{DS} = -24V, V_{GS} = 0V$			-1	μA
		$V_{DS} = -20V, V_{GS} = 0V, T_J = 125\text{ }^\circ\text{C}$			-10	
On-State Drain Current ¹	$I_{D(ON)}$	$V_{DS} = -5V, V_{GS} = -4.5V$	-4			A
Drain-Source On-State Resistance ¹	$R_{DS(ON)}$	$V_{GS} = -10V, I_D = -4.5A$		32	38	m Ω
		$V_{GS} = -4.5V, I_D = -4A$		39	44	
		$V_{GS} = -2.5V, I_D = -3A$		60	75	
Forward Transconductance ¹	g_{fs}	$V_{DS} = -5V, I_D = -4A$		13		S
DYNAMIC						
Input Capacitance	C_{iss}	$V_{GS} = 0V, V_{DS} = -15V, f = 1MHz$		1170		pF
Output Capacitance	C_{oss}			185		
Reverse Transfer Capacitance	C_{rss}			137		
Total Gate Charge ^{1,2}	Q_g	$V_{DS} = -15V, V_{GS} = -4.5V,$ $I_D = -4A$		14.2		nC
Gate-Source Charge ^{1,2}	Q_{gs}			3.2		
Gate-Drain Charge ^{1,2}	Q_{gd}			4.1		
Turn-On Delay Time ^{1,2}	$t_{d(on)}$	$V_{DS} = -15V,$ $I_D = -1A, V_{GS} = -4.5V, R_{GS} = 6\Omega$		10		nS
Rise Time ^{1,2}	t_r			10		
Turn-Off Delay Time ^{1,2}	$t_{d(off)}$			45		
Fall Time ^{1,2}	t_f			15		
SOURCE-DRAIN DIODE RATINGS AND CHARACTERISTICS ($T_C = 25\text{ }^\circ\text{C}$)						
Continuous Current	I_S				-3	A
Pulsed Current ³	I_{SM}				-12	
Forward Voltage ¹	V_{SD}	$I_F = I_S, V_{GS} = 0V$			-1.2	V

¹Pulse test : Pulse Width $\leq 300\text{ }\mu\text{sec}$, Duty Cycle $\leq 2\%$.

²Independent of operating temperature.

³Pulse width limited by maximum junction temperature.

EMC will review datasheet by quarter, and update new version.

TYPICAL CHARACTERISTICS

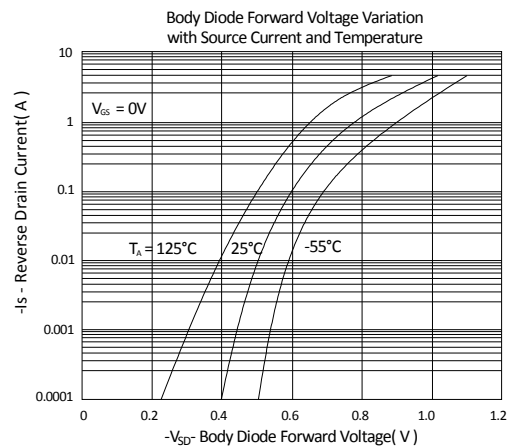
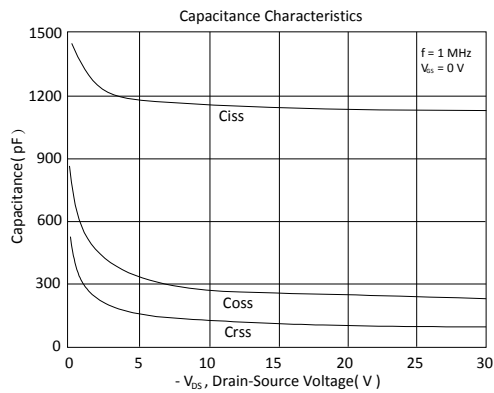
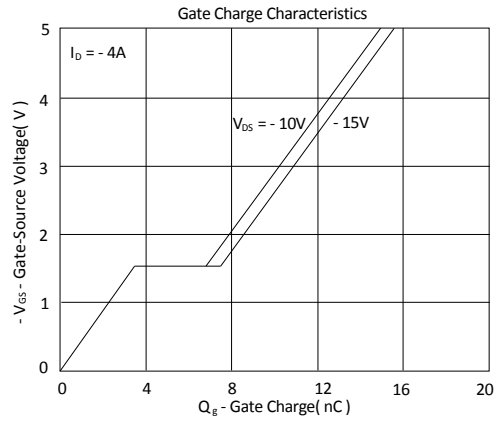
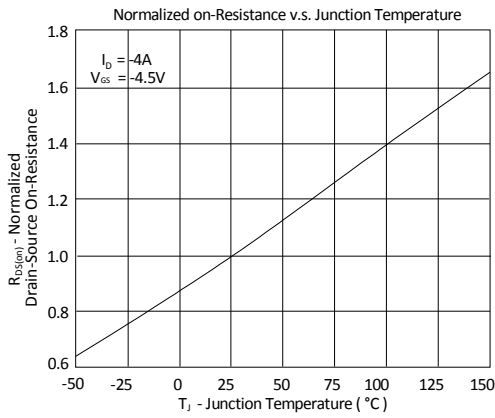
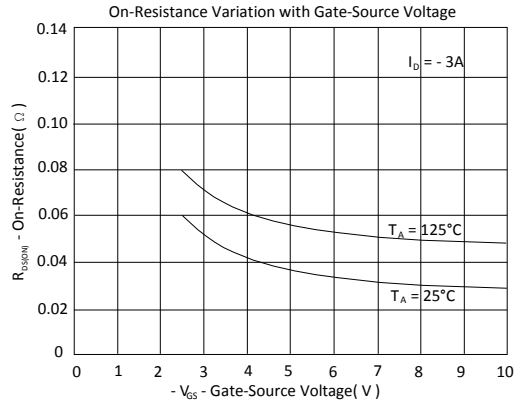
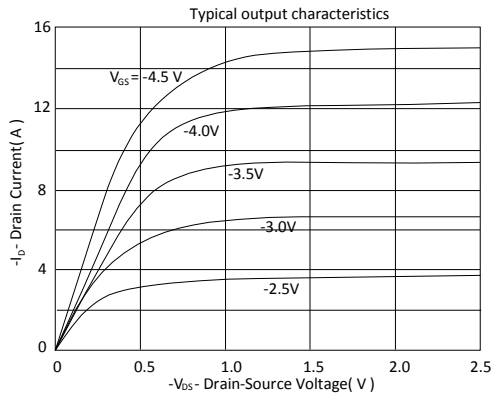

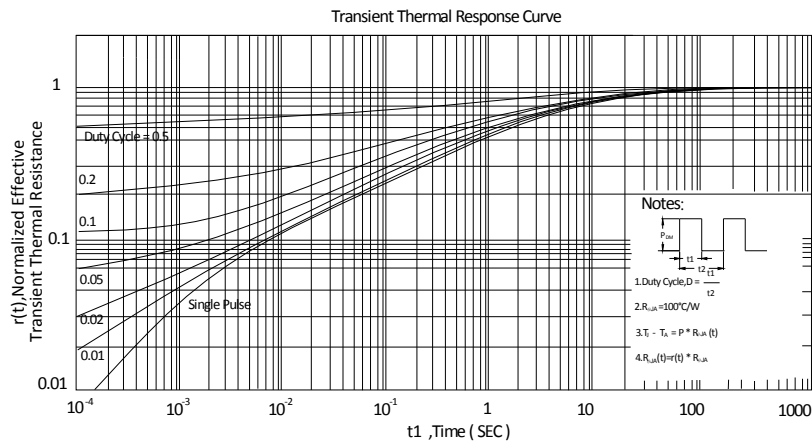
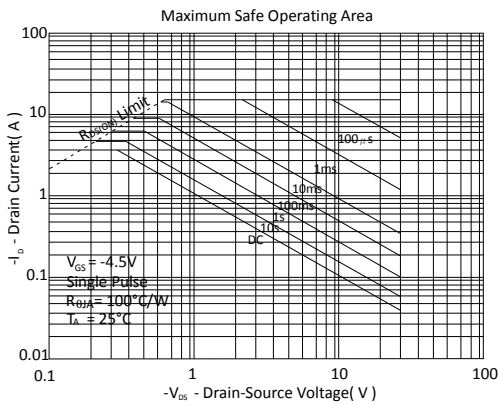
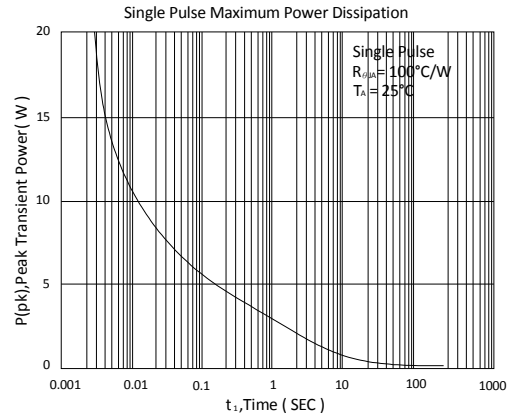
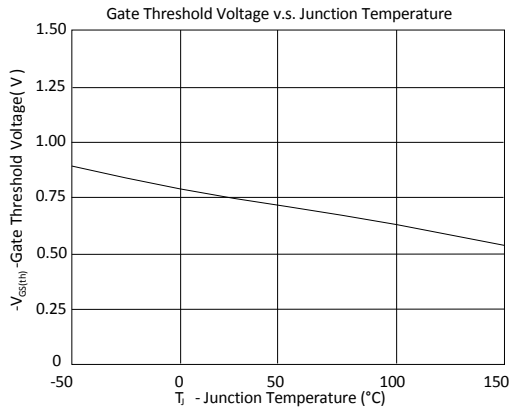

Ordering & Marking Information:

Device Name: EMF44P03J for SOT23-3

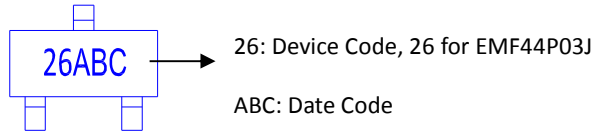

Outline Drawing

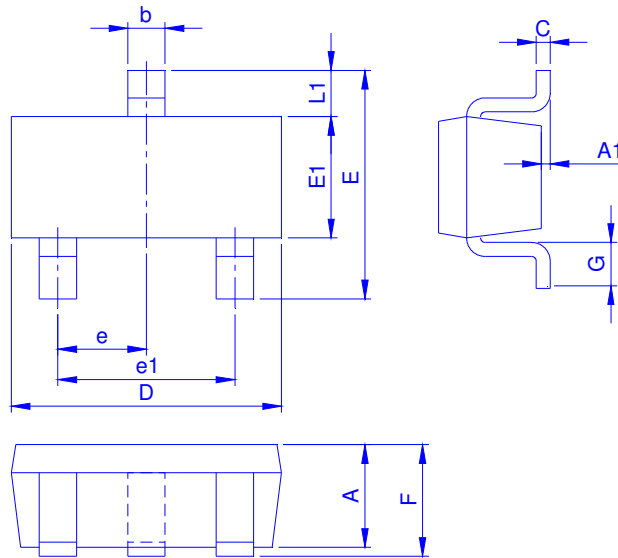

Dimension in mm

Dimension	A	A1	b	C	D	E	E1	e	e1	F	G	L1
Min.	0.70	-	0.30	0.080	2.80	2.10	1.20	0.90	1.80	0.80	0.30	0.54
Typ.	0.95	-	0.40	0.127	2.90	2.50	1.30	0.95	1.90	0.95	0.40	0.57
Max.	1.20	0.15	0.50	0.202	3.10	3.00	1.80	1.00	2.00	1.25	0.60	0.70

Footprint

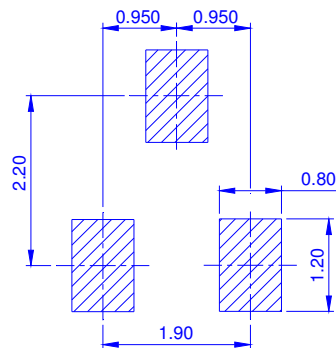

◆ Tape&Reel Information:3000pcs/Reel

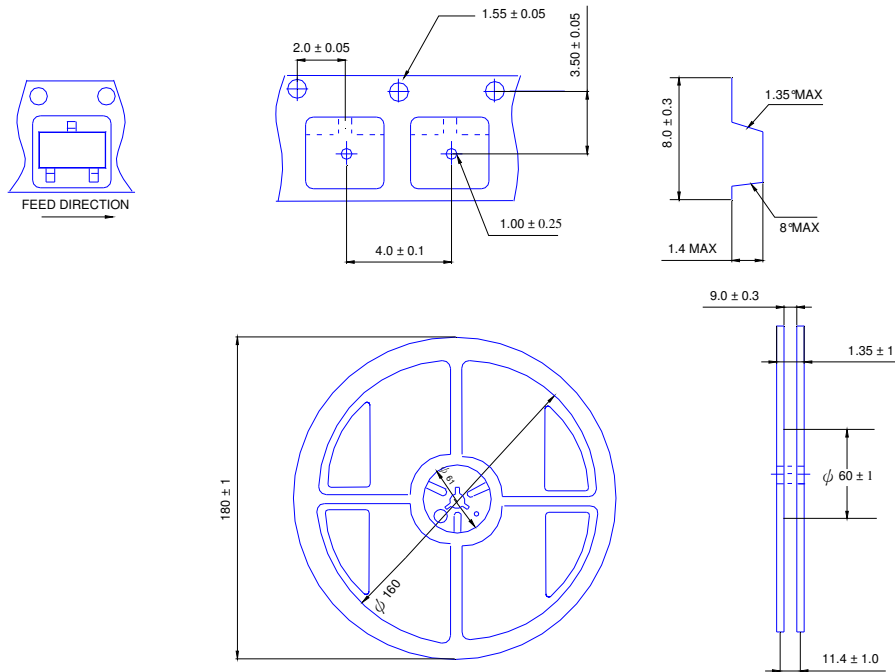

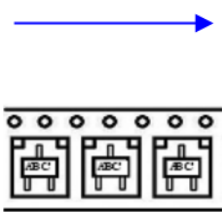
產品別	SOT23-3
Reel 尺寸	7"
編帶方式	FEED DIRECTION 
前空格	50
後空格	50
裝箱數	
滿捲數量	3K
捲/內盒比	5 : 1
內盒滿箱數	15K
內/外箱比	12 : 1
外箱滿箱數	180K