

Single N-Channel Logic Level Enhancement Mode Field Effect Transistor

▪ Product Summary:

	N-CH
BV_{DSS}	30V
$R_{DSON (MAX.)}@V_{GS}=10V$	3.0m Ω
$R_{DSON (MAX.)}@V_{GS}=4.5V$	4.0m Ω
$I_D @T_C=25^\circ C$	115A

▪ Pin Description:

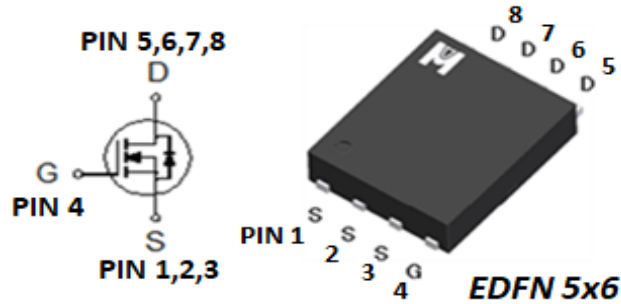

Single N Channel MOSFET

UIS, Rg 100% Tested

RoHS & Halogen Free & TSCA Compliant



▪ ABSOLUTE MAXIMUM RATINGS ($T_C = 25^\circ C$ Unless Otherwise Noted)

PARAMETERS/TEST CONDITIONS	SYMBOL	LIMITS	UNIT
Gate-Source Voltage	V_{GS}	± 20	V
Continuous Drain Current	I_D	$T_C = 25^\circ C$	115
		$T_C = 100^\circ C$	76
Continuous Drain Current	I_D	$T_A = 25^\circ C$	21
		$T_A = 70^\circ C$	16
Pulsed Drain Current ¹	I_{DM}	243	A
Avalanche Current ^{1,4}	I_{AS}	58	
Avalanche Energy ^{1,4}	E_{AS}	168	
Repetitive Avalanche Energy ^{2,4}	E_{AR}	84	
Power Dissipation ¹	P_D	$T_C = 25^\circ C$	74
		$T_C = 100^\circ C$	29
Power Dissipation ¹	P_D	$T_A = 25^\circ C$	2.2
		$T_A = 70^\circ C$	1.4
Operating Junction & Storage Temperature Range	T_{j}, T_{stg}	-55 to 150	$^\circ C$

◆ 100% UIS testing in condition of $V_D=25V$, $L=0.1mH$, $V_G=10V$, $I_L=40A$, Rated $V_{DS}=30V$ N-CH

▪ THERMAL RESISTANCE RATINGS

THERMAL RESISTANCE	SYMBOL	TYPICAL	MAXIMUM	UNIT
Junction-to-Case	$R_{\theta JC}$		1.7	$^\circ C / W$
Junction-to-Ambient ³	$t \leq 10s$	$R_{\theta JA}$	20	
	Steady-State	$R_{\theta JA}$	56	

¹Pulse width limited by maximum junction temperature.

²Duty cycle < 1%

³The value of $R_{\theta JA}$ is measured with the device mounted on 1in² FR-4 board with 2oz. Copper, in a still air environment with $T_A = 25^\circ C$.

⁴Guarantee by Engineering test

▪ ELECTRICAL CHARACTERISTICS (T_J = 25 °C, Unless Otherwise Noted)

PARAMETER	SYMBOL	TEST CONDITIONS	LIMITS			UNIT
			MIN	TYP	MAX	
STATIC						
Drain-Source Breakdown Voltage ⁴	V _{(BR)DSS}	V _{GS} = 0V, I _D = 250μA	30			V
Gate Threshold Voltage ⁴	V _{GS(th)}	V _{DS} = V _{GS} , I _D = 250μA	1.2	1.6	2.5	
Gate-Body Leakage ⁴	I _{GSS}	V _{DS} = 0V, V _{GS} = ±20V			±100	nA
Zero Gate Voltage Drain Current ⁴	I _{DSS}	V _{DS} = 30V, V _{GS} = 0V			1	μA
		V _{DS} = 30V, V _{GS} = 0V, T _J = 125 °C			25	
On-State Drain Current ¹	I _{D(ON)}	V _{DS} = 10V, V _{GS} = 10V	115			A
Drain-Source On-State Resistance ^{1,4}	R _{DS(ON)}	V _{GS} = 10V, I _D = 30A		2.5	3.0	mΩ
		V _{GS} = 4.5V, I _D = 24A		3.3	4.0	
Forward Transconductance ¹	g _{fs}	V _{DS} = 5V, I _D = 10A		90		S
DYNAMIC						
Input Capacitance ⁵	C _{iss}	V _{GS} = 0V, V _{DS} = 15V, f = 1MHz		2750		pF
Output Capacitance ⁵	C _{oss}			365		
Reverse Transfer Capacitance ⁵	C _{rss}			210		
Gate Resistance ^{4,5}	R _g	f = 1MHz		1.3		Ω
Total Gate Charge ^{1,2,5}	Q _g (V _{GS} =10V)	V _{DS} = 15V, V _{GS} = 10V, I _D = 30A		50		nC
	Q _g (V _{GS} =4.5V)			23		
Gate-Source Charge ^{1,2,5}	Q _{gs}			9.2		
Gate-Drain Charge ^{1,2,5}	Q _{gd}			7.6		
Turn-On Delay Time ^{1,2,5}	t _{d(on)}		V _{DS} = 15V, V _{GS} = 10V, I _D = 5A, R _g = 3Ω		8.3	
Rise Time ^{1,2,5}	t _r			10		
Turn-Off Delay Time ^{1,2,5}	t _{d(off)}			39		
Fall Time ^{1,2,5}	t _f			17		
SOURCE-DRAIN DIODE RATINGS AND CHARACTERISTICS						
Continuous Current	I _S				61	A
Pulsed Current ³	I _{SM}				243	
Forward Voltage ^{1,4}	V _{SD}	I _F = I _S , V _{GS} = 0V			1.2	V
Reverse Recovery Time ⁵	t _{rr}	I _F = 30A, dI _F /dt = 100A / μS		14		nS
Peak Reverse Recovery Current ⁵	I _{RM(REC)}			2.2		A
Reverse Recovery Charge ⁵	Q _{rr}			16		nC

¹Pulse test : Pulse Width ≤ 300 usec, Duty Cycle ≤ 2%.

²Independent of operating temperature.

³Pulse width limited by maximum junction temperature.

⁴Guarantee by FT test Item

⁵Guarantee by Engineering test

EMC will review datasheet by quarter, and update new version.

TYPICAL CHARACTERISTICS

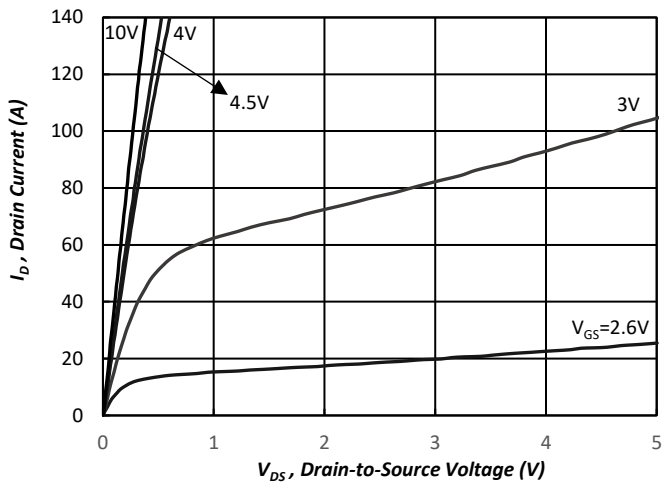

Fig.1 Typical Output Characteristics

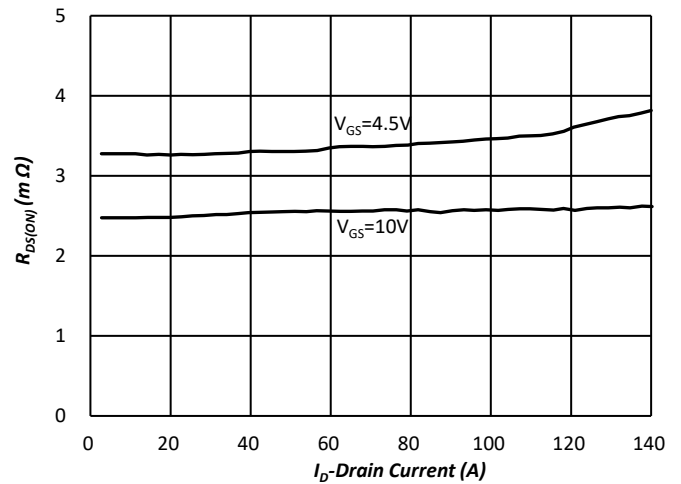

Fig.2 On-Resistance Variation with Drain Current and Gate Voltage

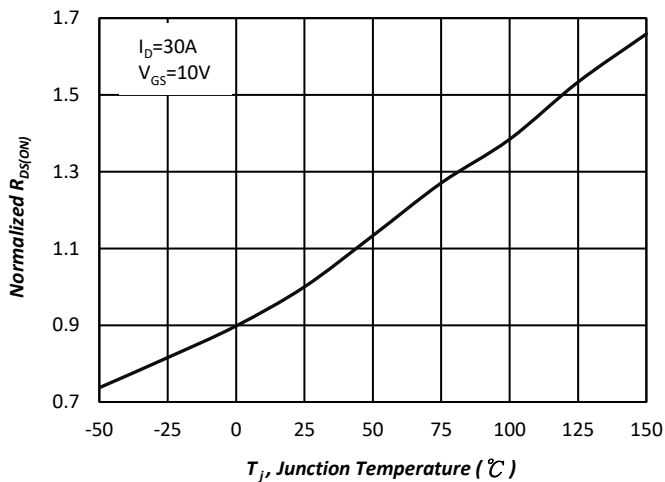

Fig.3 Normalized On-Resistance v.s. Junction Temperature

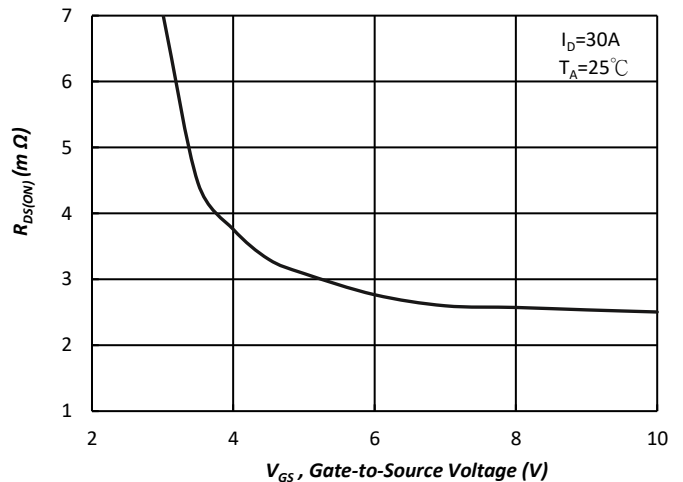

Fig.4 On-Resistance v.s. Gate Voltage

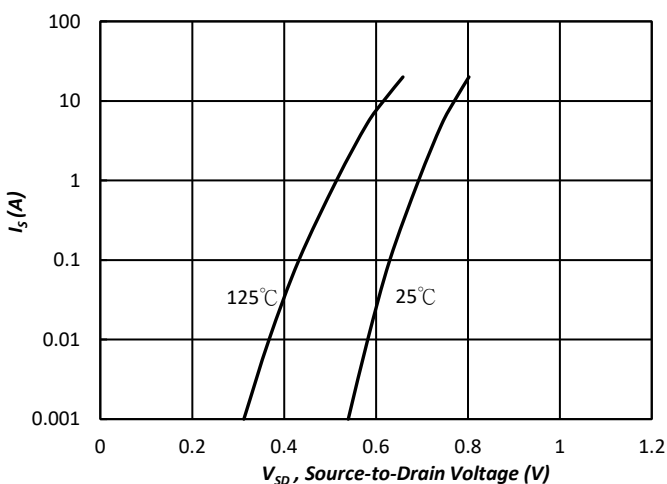

Fig.5 Forward Characteristic of Reverse Diode

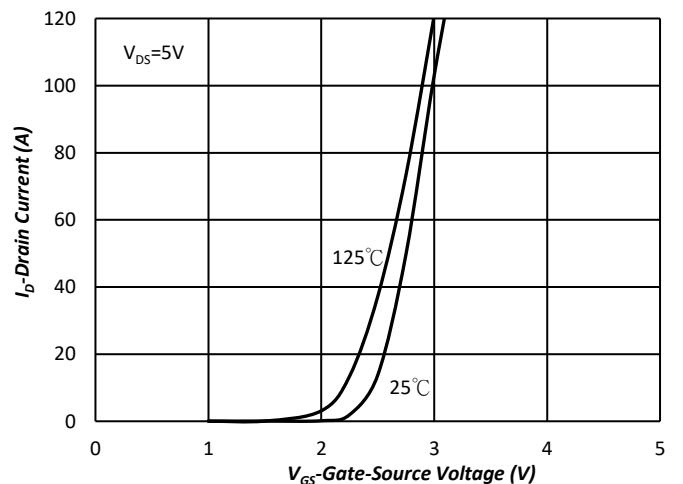

Fig.6 Transfer Characteristics

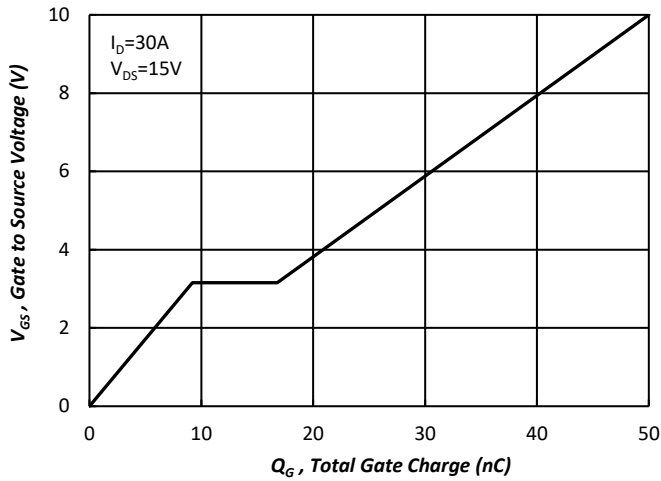

Fig.7 Gate Charge Characteristics

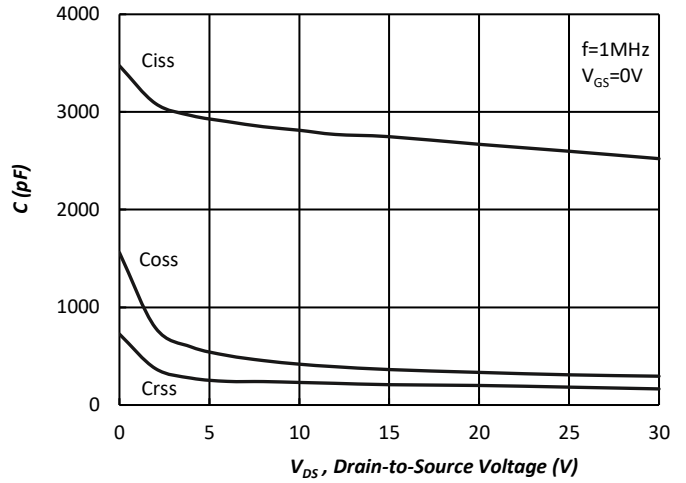

Fig.8 Typical Capacitance Characteristics

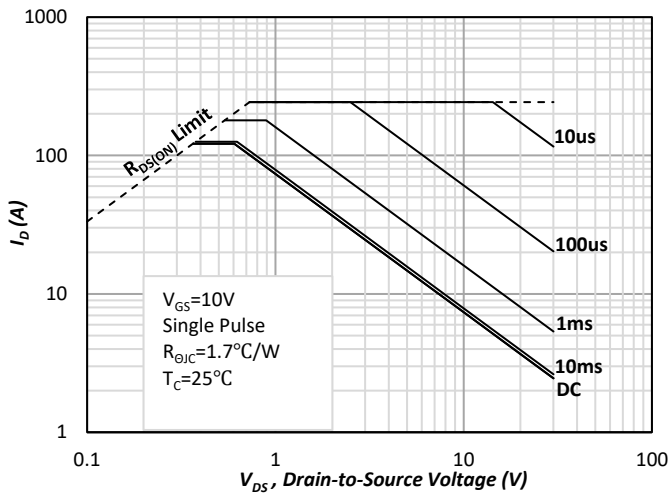

Fig.9. Maximum Safe Operating Area

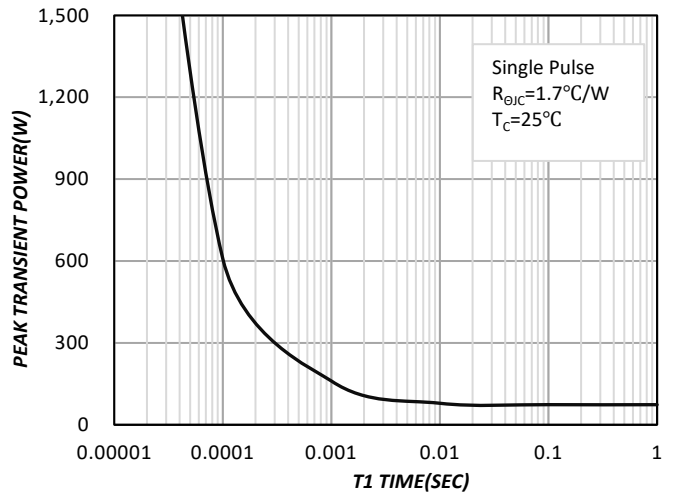

Fig.10. Single Pulse Maximum Power Dissipation

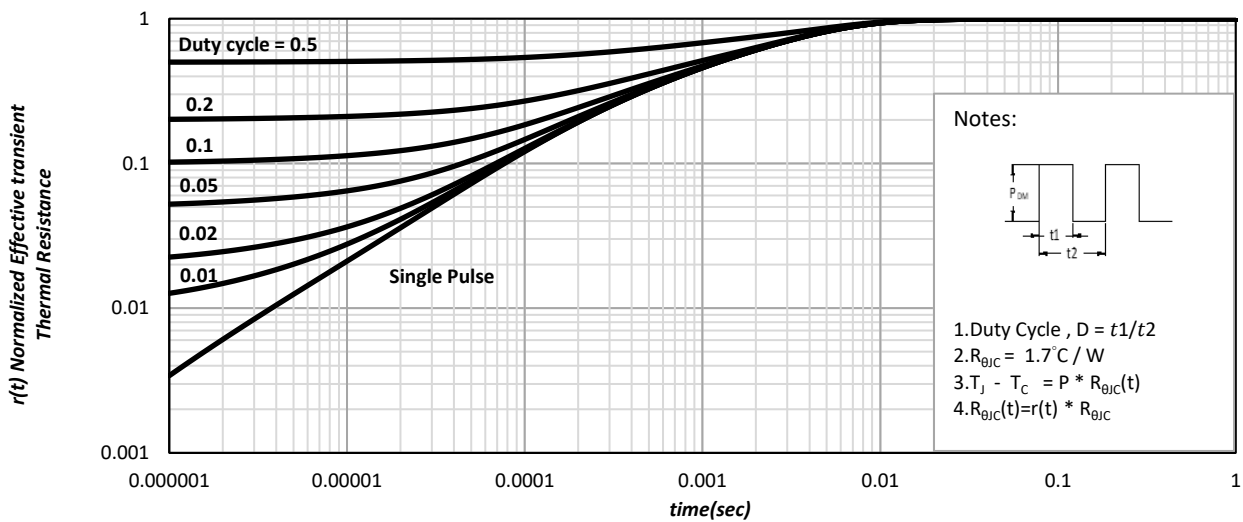

Fig.11. Effective Transient Thermal Impedance

Ordering & Marking Information:

Device Name: EMB03N03HR for EDFN 5x6



→ B03N03R: Device Name

→ ABCDEFG: Date Code

A: Assembly House

B: Year(A:2008 B:2009 C:2010....)

C: Month(A:01 B:02 C:03 D:04 E:05 F:06 G:07 H:08 I:09 J:10 K:11 L:12)

DEFG: Serial No.

Outline Drawing

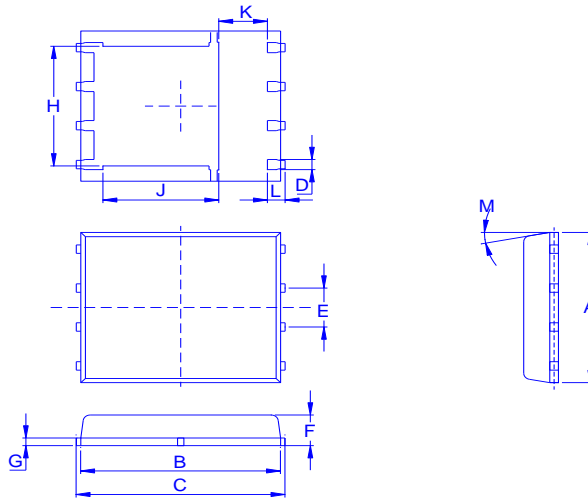

Dimension	A	B	C	D	E	F	G	H	J	K	L	M
Min	4.80	5.55	5.90	0.30	1.17	0.85	0.15	3.61	3.18	1.00	0.38	0°
Typ.	4.90	5.70	6.00	0.40	1.27	0.95	0.20	3.87	3.44	1.20	0.40	
Max	5.40	5.85	6.15	0.51	1.37	1.17	0.34	4.31	3.78	1.39	0.71	12°

Footprint

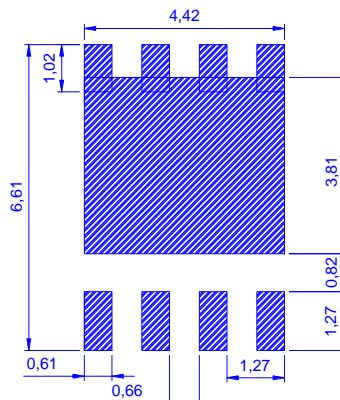

◆ **Tape&Reel Information:2500pcs/Reel**

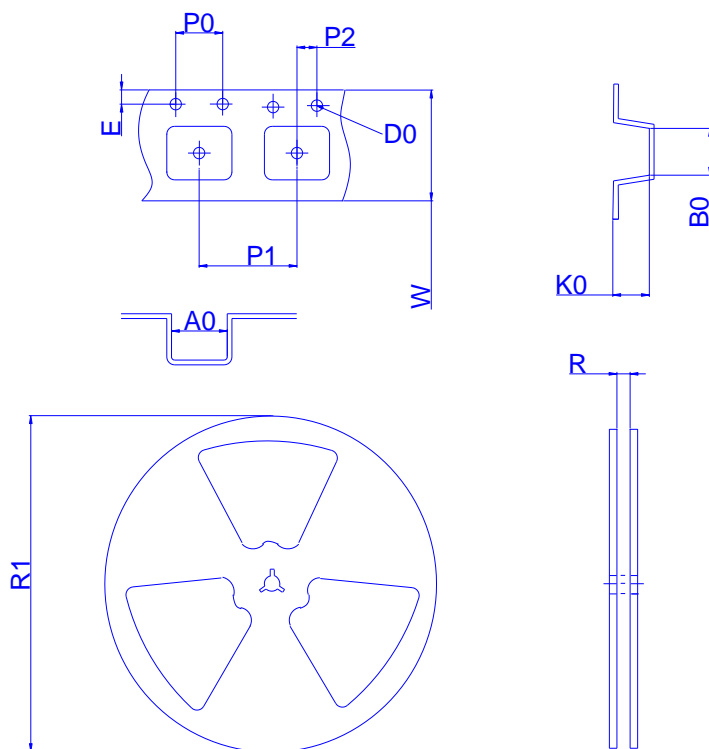

Package	EDFN5X6
Reel	13"
Device orientation	<p>FEED DIRECTION</p> <p>→</p>

Dimension in mm

Dimension	Carrier tape									Reel	
	A0	B0	D0	E	K0	P0	P1	P2	W	R	R1
Typ.	6.4	5.3	1.5	1.8	1.6	4	8	2	12	12.4	330
±	0.2	0.2	0.1	0.1	0.6	0.1	0.1	0.1	0.3	2	2