

Data Sheet

Customer: _____

Product: Transient Voltage Suppressors 600W – P6SMB Series

Package : DO-214AA(SMB)

Issued Date: 10-Feb.-2015

Edition: Ver. 1

Record of change

Date	Ver.	Description	Page
10-Feb.-2015	1		

HITANO ENTERPRISE CORP.

7F-7, No. 3, Wu Chuan 1st Road, New Taipei Industrial Park,
New Taipei City, TAIWAN, R.O.C.

Tel: +886 2 2299 1331 (Rep.)

Fax: +886 2 2298 2466, 2298 2969

Prepared by	Checked by	Approved by	Accepted by (customer)
10-Feb.-2015	10-Feb.-2015	10-Feb.-2015	
<i>Andy Hsu</i>	<i>Hwa Wu</i>	<i>Hwa Wu</i>	

600W SURFACE MOUNT TRANSIENT VOLTAGE SUPPRESSOR

FEATURES

- OPTIMIZED FOR LAN PROTECTION APPLICATION.
- IDEAL FOR ESD PROTECTION OF DATA LINES IN ACCORDANCE WITH IEC 1000-4-2(IEC801-2).
- IDEAL FOR EFT PROTECTION OF DATA LINE IN ACCORDANCE WITH IEC 1000-4-4(IEC801-4).
- EXCELLENT CLAMPING CAPABILITY.
- LOW INCREMENTAL SURGE RESISTANCE.
- FAST RESPONSE TIME:TYPICALLY LESS THAN 1.0 ps FROM 0 VOLTS TO V(BR) MIN.
- 600 W PEAK PULSE POWER CAPABILITY WITH A 10/1000 μ S WAVEFORM , REPETITION RATE (DUTY CYCLE) : 0.01%.
- TYPICAL I_D LESS THAN 1 μ A ABOVE 10V.
- HIGH TEMPERATURE SOLDERING GUARANTEED:250 $^{\circ}$ C/10 SECONDS AT TERMINAL.
- ROHS & REACH COMPLIANT

MECHANICAL DATA

- CASE : MOLDED PLASTIC
- TERMINALS : SOLDER PLATED
- POLARITY : INDICATED BY CATHODE BAND
- WEIGHT : 0.093 GRAMS

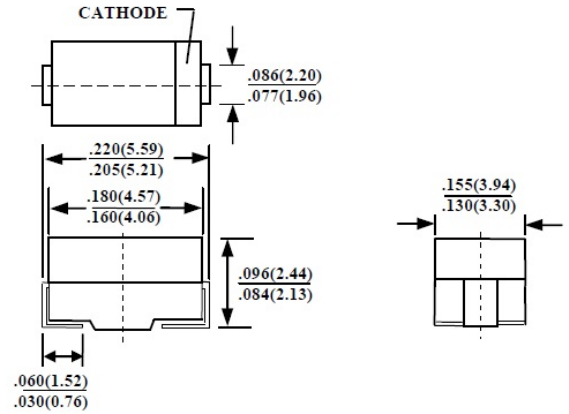

CASE : DO-214AA(SMB)
DIMENSIONS IN INCHES AND (MILLIMETERS)

MAXIMUM RATINGS AND ELECTRICAL CHARACTERISTICS
RATINGS AT 25 $^{\circ}$ C AMBIENT TEMPERATURE UNLESS OTHERWISE SPECIFIED

RATINGS	SYMBOL	VALUE	UNITS
PEAK PULSE POWER DISSIPATION ON 10/1000 μ S WAVEFORM (NOTE 1, FIG. 1)	P_{PPM}	MINIMUM 600	WATTS
PEAK PULSE CURRENT OF 0N 10/1000 μ S WAVEFORM (NOTE 1,FIG. 3)	I_{PPM}	SEE NEXT TABLE	A
STEADY STATE POWER DISSIPATION AT $T_L=75^{\circ}$ C (NOTE 2)	$P_{M(AV)}$	5.0	WATTS
OPERATING JUNCTION AND STORAGE TEMPERATURE RANGE	T_J, T_{STG}	- 55 TO + 150	$^{\circ}$ C

- NOTE :
1. NON-REPETITIVE CURRENT PULSE, PER FIG.3 AND DERATED ABOVE $T_A=25^{\circ}$ C PER FIG 2.
 2. MOUNTED ON 5mm² COPPER PADS TO EACH TERMINAL
 3. MEASURED ON 8.3ms SINGLE HALF SINE-WAVE OR EQUIVALENT SQUARE WAVE, DUTY CYCLE = 4 PULSES PER MINUTE MAXIMUM

Part Number (Uni)	Part Number (Bi)	DEVICE MARKING		WORKING PEAK REVERSE VOLTAGE $V_{RWM}(VOLTS)$ @IT (mA)	BREAKDOWN VOLTAGE $V_{(BR)}$ (VOLTS)		TEST CURREN T $I_T(mA)$	MAXIMUM CLAMPING VOLTAGE AT I_{PPM} VC(Volts)	MAX PEAK PULSE SURGE CURRENT I_{PPM} (Amps)	MAXIMUM REVERSE LEAKAGE AT V_{WM} $I_D(\mu A)$
		UNI	BI		MIN	MAX				
P6SMBJ5.0	P6SMBJ5.0C	KD	AD	5.0	6.40	7.82	10	9.6	62.5	800
P6SMBJ5.0A	P6SMBJ5.0CA	KE	AE	5.0	6.40	7.07	10	9.2	65.2	800
P6SMBJ6.0	P6SMBJ6.0C	KF	AF	6.0	6.67	8.15	10	11.4	52.6	800
P6SMBJ6.0A	P6SMBJ6.0CA	KG	AG	6.0	6.67	7.37	10	10.3	58.3	800
P6SMBJ6.5	P6SMBJ6.5C	KH	AH	6.5	7.22	8.82	10	12.3	48.8	500
P6SMBJ6.5A	P6SMBJ6.5CA	KK	AK	6.5	7.22	7.98	10	11.2	53.6	500
P6SMBJ7.0	P6SMBJ7.0C	KL	AL	7.0	7.78	9.51	10	13.3	45.1	200
P6SMBJ7.0A	P6SMBJ7.0CA	KM	AM	7.0	7.78	8.60	10	12.0	50.0	200
P6SMBJ7.5	P6SMBJ7.5C	KN	AN	7.5	8.33	10.2	1.0	14.3	42.0	100
P6SMBJ7.5A	P6SMBJ7.5CA	KP	AP	7.5	8.33	9.21	1.0	12.9	46.5	100
P6SMBJ8.0	P6SMBJ8.0C	KQ	AQ	8.0	8.89	10.9	1.0	15.0	40.0	50.0
P6SMBJ8.0A	P6SMBJ8.0CA	KR	AR	8.0	8.89	9.83	1.0	13.6	44.1	50.0
P6SMBJ8.5	P6SMBJ8.5C	KS	AS	8.5	9.44	11.5	1.0	15.9	37.7	10.0
P6SMBJ8.5A	P6SMBJ8.5CA	KT	AT	8.5	9.44	10.4	1.0	14.4	41.7	10.0
P6SMBJ9.0	P6SMBJ9.0C	KU	AU	9.0	10.0	12.2	1.0	16.9	35.5	5.0
P6SMBJ9.0A	P6SMBJ9.0CA	KV	AV	9.0	10.0	11.1	1.0	15.4	39.0	5.0
P6SMBJ10	P6SMBJ10C	KW	AW	10.0	11.1	13.6	1.0	18.8	31.9	5.0
P6SMBJ10A	P6SMBJ10CA	KX	AX	10.0	11.1	12.3	1.0	17.0	35.3	5.0
P6SMBJ11	P6SMBJ11C	KY	AY	11.0	12.2	14.9	1.0	20.1	29.9	5.0
P6SMBJ11A	P6SMBJ11CA	KZ	AZ	11.0	12.2	13.5	1.0	18.2	33.0	5.0
P6SMBJ12	P6SMBJ12C	LD	BD	12.0	13.3	16.3	1.0	22.0	27.3	5.0
P6SMBJ12A	P6SMBJ12CA	LE	BE	12.0	13.3	14.7	1.0	19.9	30.2	5.0
P6SMBJ13	P6SMBJ13C	LF	BF	13.0	14.4	17.6	1.0	23.8	25.2	5.0
P6SMBJ13A	P6SMBJ13CA	LG	BG	13.0	14.4	15.9	1.0	21.5	27.9	5.0
P6SMBJ14	P6SMBJ14C	LH	BH	14.0	15.6	19.1	1.0	25.8	23.3	5.0
P6SMBJ14A	P6SMBJ14CA	LK	BK	14.0	15.6	17.2	1.0	23.2	25.9	5.0
P6SMBJ15	P6SMBJ15C	LL	BL	15.0	16.7	20.4	1.0	26.9	22.3	5.0
P6SMBJ15A	P6SMBJ15CA	LM	BM	15.0	16.7	18.5	1.0	24.4	24.6	5.0
P6SMBJ16	P6SMBJ16C	LN	BN	16.0	17.8	21.8	1.0	28.8	20.8	5.0
P6SMBJ16A	P6SMBJ16CA	LP	BP	16.0	17.8	19.7	1.0	26.0	23.1	5.0
P6SMBJ17	P6SMBJ17C	LQ	BQ	17.0	18.9	23.1	1.0	30.5	19.7	5.0
P6SMBJ17A	P6SMBJ17CA	LR	BR	17.0	18.9	20.9	1.0	27.6	21.7	5.0
P6SMBJ18	P6SMBJ18C	LS	BS	18.0	20.0	24.4	1.0	32.2	18.6	5.0
P6SMBJ18A	P6SMBJ18CA	LT	BT	18.0	20.0	22.1	1.0	29.2	20.5	5.0
P6SMBJ20	P6SMBJ20C	LU	BU	20.0	22.2	27.1	1.0	35.8	16.8	5.0
P6SMBJ20A	P6SMBJ20CA	LV	BV	20.0	22.2	24.5	1.0	32.4	18.5	5.0
P6SMBJ22	P6SMBJ22C	LW	BW	22.0	24.4	29.8	1.0	39.4	15.2	5.0
P6SMBJ22A	P6SMBJ22CA	LX	BX	22.0	24.4	26.9	1.0	35.5	16.9	5.0
P6SMBJ24	P6SMBJ24C	LY	BY	24.0	26.7	32.6	1.0	43.0	14.0	5.0
P6SMBJ24A	P6SMBJ24CA	LZ	BZ	24.0	26.7	29.5	1.0	38.9	15.4	5.0
P6SMBJ26	P6SMBJ26C	MD	CD	26.0	28.9	35.3	1.0	46.6	12.9	5.0
P6SMBJ26A	P6SMBJ26CA	ME	CE	26.0	28.9	31.9	1.0	42.1	14.3	5.0
P6SMBJ28	P6SMBJ28C	MF	CF	28.0	31.1	38.0	1.0	50.0	12.0	5.0
P6SMBJ28A	P6SMBJ28CA	MG	CG	28.0	31.1	34.4	1.0	45.4	13.2	5.0
P6SMBJ30	P6SMBJ30C	MH	CH	30.0	33.3	40.7	1.0	53.5	11.2	5.0
P6SMBJ30A	P6SMBJ30CA	MK	CK	30.0	33.3	36.8	1.0	48.4	12.4	5.0
P6SMBJ33	P6SMBJ33C	ML	CL	33.0	36.7	44.9	1.0	59.0	10.2	5.0
P6SMBJ33A	P6SMBJ33CA	MM	CM	33.0	36.7	40.6	1.0	53.3	11.3	5.0
P6SMBJ36	P6SMBJ36C	MN	CN	36.0	40.0	48.9	1.0	64.3	9.3	5.0
P6SMBJ36A	P6SMBJ36CA	MP	CP	36.0	40.0	44.2	1.0	58.1	10.3	5.0
P6SMBJ40	P6SMBJ40C	MQ	CQ	40.0	44.4	54.3	1.0	71.4	8.4	5.0
P6SMBJ40A	P6SMBJ40CA	MR	CR	40.0	44.4	49.1	1.0	64.5	9.3	5.0
P6SMBJ43	P6SMBJ43C	MS	CS	43.0	47.8	58.4	1.0	76.7	7.8	5.0
P6SMBJ43A	P6SMBJ43CA	MT	CT	43.0	47.8	52.8	1.0	69.4	8.6	5.0
P6SMBJ45	P6SMBJ45C	MU	CU	45.0	50.0	61.1	1.0	80.3	7.5	5.0
P6SMBJ45A	P6SMBJ45CA	MV	CV	45	50.0	55.3	1.0	72.7	8.3	5.0
P6SMBJ48	P6SMBJ48C	MW	CW	48	53.3	65.1	1.0	85.5	7.0	5.0
P6SMBJ48A	P6SMBJ48CA	MX	CX	48	53.3	58.9	1.0	77.4	7.8	5.0
P6SMBJ51	P6SMBJ51C	MY	CY	51	56.7	69.3	1.0	91.1	6.6	5.0
P6SMBJ51A	P6SMBJ51CA	MZ	CZ	51	56.7	62.7	1.0	82.4	7.3	5.0
P6SMBJ54	P6SMBJ54C	ND	DD	54	60.0	73.3	1.0	96.3	6.2	5.0
P6SMBJ54A	P6SMBJ54CA	NE	DE	54	60.0	66.3	1.0	87.1	6.9	5.0
P6SMBJ58	P6SMBJ58C	NF	DF	58	64.4	78.7	1.0	103.0	5.8	5.0
P6SMBJ58A	P6SMBJ58CA	NG	DG	58	64.4	71.2	1.0	93.6	6.4	5.0
P6SMBJ60	P6SMBJ60C	NH	DH	60	66.7	81.5	1.0	107.0	5.6	5.0
P6SMBJ60A	P6SMBJ60CA	NK	DK	60	66.7	73.7	1.0	96.8	6.2	5.0
P6SMBJ64	P6SMBJ64C	NL	DL	64	71.1	86.9	1.0	114.0	5.3	5.0
P6SMBJ64A	P6SMBJ64CA	NM	DM	64	71.1	78.6	1.0	103.0	5.8	5.0

Part Number (Uni)	Part Number (Bi)	DEVICE MARKING		WORKING PEAK REVERSE VOLTAGE $V_{RWM}(VOLTS)$ @IT (mA)	BREAKDOWN VOLTAGE $V_{(BR)}$ (VOLTS)		TEST CURRENT T $I_T(mA)$	MAXIMUM CLAMPING VOLTAGE AT I_{PPM} VC(Volts)	MAX PEAK PULSE SURGE CURRENT I_{PPM} (Amps)	MAXIMUM REVERSE LEAKAGE AT V_{WM} $I_D(\mu A)$
		UNI	BI		MIN	MAX				
P6SMBJ70	P6SMBJ70C	NN	DN	70	77.8	95.1	1.0	125.0	4.8	5.0
P6SMBJ70A	P6SMBJ70CA	NP	DP	70	77.8	86.0	1.0	113.0	5.3	5.0
P6SMBJ75	P6SMBJ75C	NQ	DQ	75	83.3	102.0	1.0	134.0	4.5	5.0
P6SMBJ75A	P6SMBJ75CA	NR	DR	75	83.3	92.1	1.0	121.0	5.0	5.0
P6SMBJ78	P6SMBJ78C	NS	DS	78	86.7	106.0	1.0	139.0	4.3	5.0
P6SMBJ78A	P6SMBJ78CA	NT	DT	78	86.7	95.8	1.0	126.0	4.8	5.0
P6SMBJ85	P6SMBJ85C	NU	DU	85	94.4	115.0	1.0	151.0	4.0	5.0
P6SMBJ85A	P6SMBJ85CA	NV	DV	85	94.4	104.0	1.0	137.0	4.4	5.0
P6SMBJ90	P6SMBJ90C	NW	DW	90	100.0	122.0	1.0	160.0	3.8	5.0
P6SMBJ90A	P6SMBJ90CA	NX	DX	90	100.0	111.0	1.0	146.0	4.1	5.0
P6SMBJ100	P6SMBJ100C	NY	DY	100	111.0	136.0	1.0	179.0	3.4	5.0
P6SMBJ100A	P6SMBJ100CA	NZ	DZ	100	111.0	123.0	1.0	162.0	3.7	5.0
P6SMBJ110	P6SMBJ110C	PD	ED	110	122.0	149.0	1.0	196.0	3.1	5.0
P6SMBJ110A	P6SMBJ110CA	PE	EE	110	122.0	135.0	1.0	177.0	3.4	5.0
P6SMBJ120	P6SMBJ120C	PF	EF	120	133.0	163.0	1.0	214.0	2.8	5.0
P6SMBJ120A	P6SMBJ120CA	PG	EG	120	133.0	147.0	1.0	193.0	3.1	5.0
P6SMBJ130	P6SMBJ130C	PH	EH	130	144.0	176.0	1.0	231.0	2.6	5.0
P6SMBJ130A	P6SMBJ130CA	PK	EK	130	144.0	159.0	1.0	209.0	2.9	5.0
P6SMBJ150	P6SMBJ150C	PL	EL	150	167.0	204.0	1.0	268.0	2.2	5.0
P6SMBJ150A	P6SMBJ150CA	PM	EM	150	167.0	185.0	1.0	243.0	2.5	5.0
P6SMBJ160	P6SMBJ160C	PN	EN	160	178.0	218.0	1.0	287.0	2.1	5.0
P6SMBJ160A	P6SMBJ160CA	PP	EP	160	178.0	197.0	1.0	259.0	2.3	5.0
P6SMBJ170	P6SMBJ170C	PQ	EQ	170	189.0	231.0	1.0	304.0	2.0	5.0
P6SMBJ170A	P6SMBJ170CA	PR	ER	170	189.0	209.0	1.0	275.0	2.2	5.0
P6SMBJ180	P6SMBJ180C	PS	ES	180	200.1	244.8	1.0	322.2	1.9	5.0
P6SMBJ180A	P6SMBJ180CA	PT	ET	180	200.0	220.0	1.0	291.6	2.1	5.0
P6SMBJ190	P6SMBJ190C	PU	EU	190	211.2	258.4	1.0	340.1	1.8	5.0
P6SMBJ190A	P6SMBJ190CA	PV	EV	190	211.0	232.0	1.0	307.8	2.0	5.0
P6SMBJ200A	P6SMBJ200CA	PW	EW	200	224.0	247.0	1.0	324.0	1.9	5.0
P6SMBJ220A	P6SMBJ220CA	PX	EX	220	246.0	272.0	1.0	356.0	1.7	5.0
P6SMBJ250A	P6SMBJ250CA	PZ	EZ	250	279.0	309.0	1.0	405.0	1.5	5.0
P6SMBJ300A	P6SMBJ300CA	QE	FE	300	335.0	371.0	1.0	486.0	1.2	5.0
P6SMBJ350A	P6SMBJ350CA	QG	FG	350	391.0	432.0	1.0	567.0	1.1	5.0
P6SMBJ400A	P6SMBJ400CA	QK	FK	400	447.0	494.0	1.0	648.0	0.9	5.0
P6SMBJ440A	P6SMBJ440CA	QM	FM	440	492.0	543.0	1.0	713.0	0.8	5.0

NOTE :

1. For Bipolar types with VR of 10 volts and under , the IR limit is doubled
2. Mounted on 5.0mm² copper pads to each terminal.
3. For Bidirectional use C suffix for 10% tolerance , CA suffix for 5% tolerance

RATINGS AND CHARACTERISTIC CURVES P6SMBJ5.0 THRU P6SMBJ440A

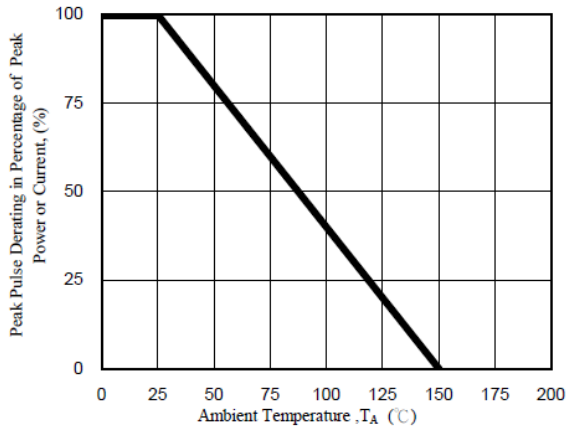

Fig. 1 - Pulse Derating Curve

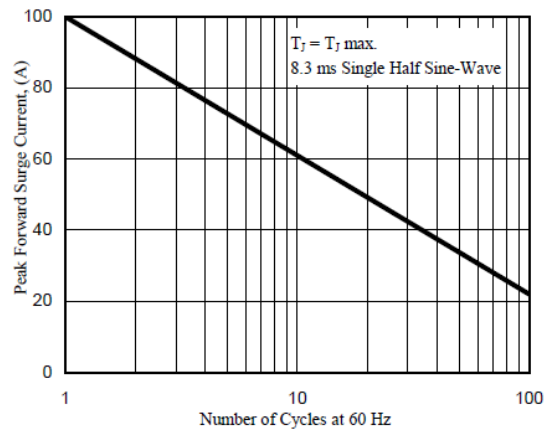

Fig. 2 - Maximum Non-Repetitive Surge Current

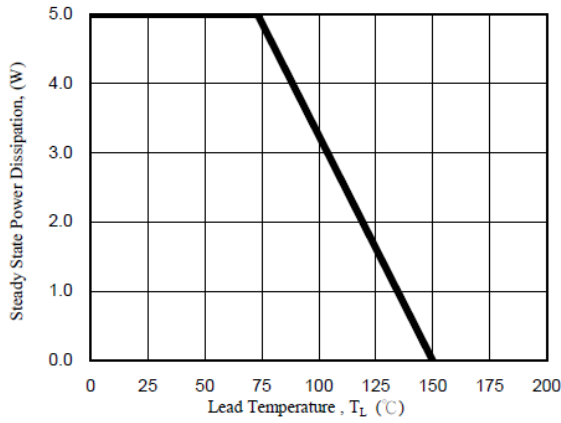

Fig. 3 - Steady State Power Derating Curve

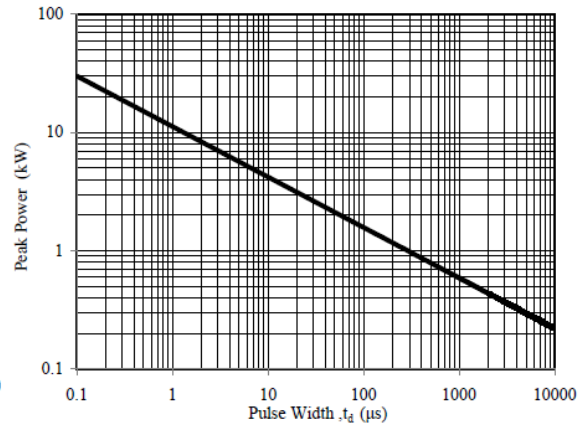

Fig. 4 - Peak Pulse Power Rating Curve

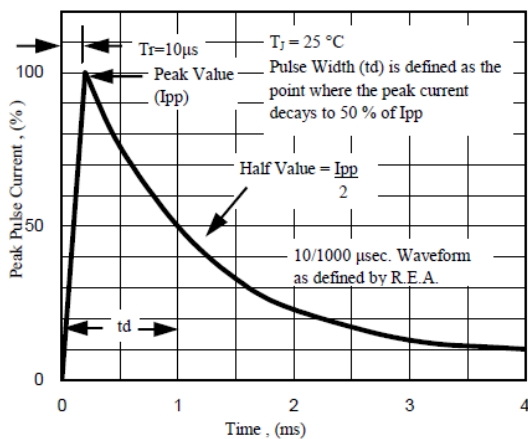

Fig. 5 - Pulse Waveform

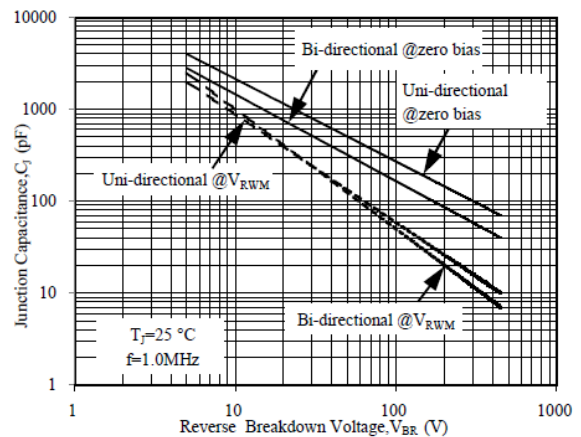

Fig. 6 - Typical Junction Capacitance