



GENERAL DESCRIPTION

The EM91415 is a series of tone/pulse switchable dialers that is composed of T/P dialer and T/P dialer with 13 set memories. The EM91415 series provide necessary functions of telephone set for application in any environment, such as Pulse dialing, Tone (DTMF) dialing, Handfree dialing, keying tone, and lock functions. The lock function is designed to inhibit toll dialing operation. Beside this, melody generator, ring detector and SDO (Serial Data Output) functions are provided in advance version. Melody generator will output dual-tone music in line hold duration. Ring detector can prevent illegal dialing from pocket dialer. The SDO is designed to drive LCD driver and voice synthesizer. In this application, the dialing numbers can be displayed on LCD screen with EM32100 (or EM32116).

FEATURES

- Tone/Pulse switchable.
- Wide operating voltage from 2.0 V to 5.5 V.
- Low operating current, 0.15 mA (Pulse) and 0.3 mA (Tone) typically.
- Adding resistor on keyboard scan pin that can select many telephone specifications, such as : Pulse rate, M/B ratio, Flash time, lock dialing functions.
- SDO function supports LCD driver and voice synthesizer to indicate dialing numbers.
- Line hold function is designed for stopping conversation temporality.
- Melody generator provides music on hold function.
- Lock function provides conventionality key lock and password lock operations.
- Ring detector is designed to prevent illegal dialing from pocket dialer.
- 13 set one touch or (3 set one touch and 10 set two touch) repertory memory, each one can hold data up to 16 digits.
- A 32-digit LNB (last number) redial memory.
- Keytone function provides rapidly keying recognition.
- Handfree function provides on-hook dialing and speakerphone application.
- Pause and P-T time are fixed to 3.6 seconds.
- Tone duration and inter-tone pause time are fixed to 98 ms.
- Using 3.579545 MHz crystal or ceramic resonator.
- Package forms: PDIP, skinny.

ORDERING INFORMATION

Versions list and function outline

VERSION	LNB	KT	HOLD(music)	LOCK	HF	SDO(LCD)	PDP
EM91415A	√	√	√	√			
EM91415B	√	√	√	√	√		
EM91415C	√	√	√	√	√	√	
EM91415D	√	√	√	√	√	√	√

Note : PDP = Pocket Dialer Prevented



EM91415

Pin Assignment

EM91415AP

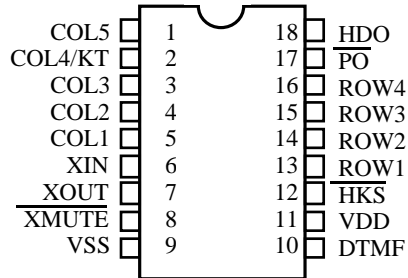

EM91415BP

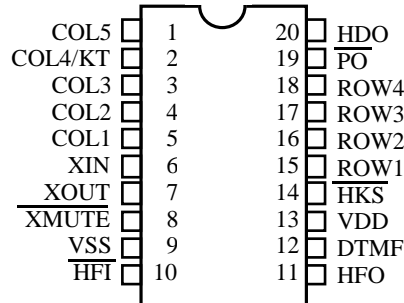

EM91415CK

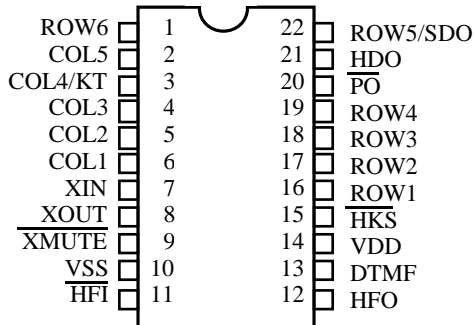

EM91415DK

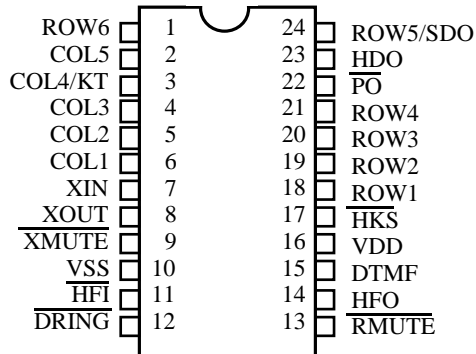

Keyboard Arrangement

	COL1	COL2	COL3	COL4/KT	COL5
ROW1	1	2	3	HD	EM1
ROW2	4	5	6	F	EM2
ROW3	7	8	9	A	EM3
ROW4	*/T	0	#	RD/P	ST
ROW5/SDO	M1	M2	M3	M4	M5
ROW6	M6	M7	M8	M9	M10

ROW5/SDO : Option by COL5

@ When ROW5 is selected by R option (COL5), there are 13 sets one touch memory version in EM91415C/D provided.

FUNCTIONAL BLOCK DIAGRAM

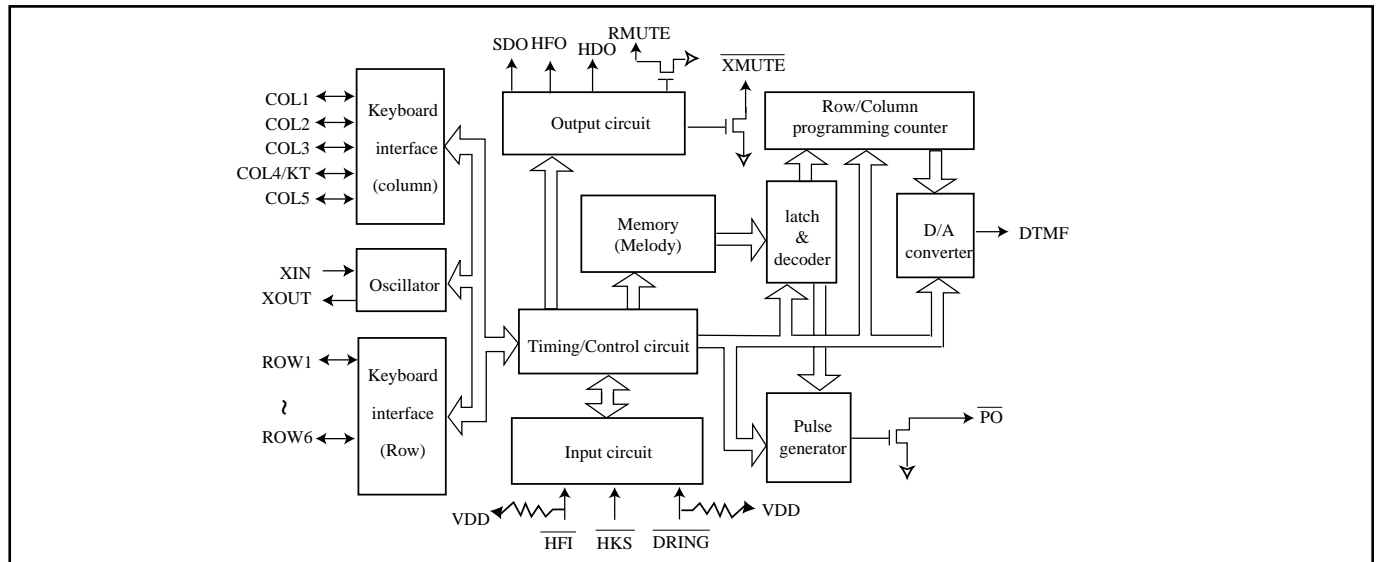

PIN DESCRIPTIONS

Symbol	Function
ROW1~ROW6	Keyboard scan pins of row group. In idle state ($\overline{\text{HKS}}$ is “High” and HFO is “Low”), these pins stay “High impedance” level to prevent power consumption. Otherwise, these pins switch to “High” level for detecting keyboard entry. These pins will output 600 Hz signal while keyboard is scanning.
COL1~COL3 and COL5	Keyboard scan pins of column group. In idle state, these pins stay “High impedance” level. Otherwise these pins switch to “Low” level for detecting keyboard entry. These pins will output 600 Hz signal while keyboard is scanning.
COL4/KT	The fourth column group pin of the keyboard that also provides the keytone output. Normally, this pin stays “Low” level for detecting keyboard entry. After a valid keyboard entry, this pin will output keying confirmation tone that is 600 Hz signal and 30 ms duration. To prevent signal interference, while DTMF issue, it will disable keytone output except function key.
XIN and XOUT	Oscillator input and output pins. A 3.579545 MHz crystal or ceramic resonator must be crossed connection to XIN and XOUT pins which generate system clock.
$\overline{\text{XMUTE}}$	The Tone/Pulse MUTE signal output pin that is NMOS open-drain output structure. This pin will switch to “Low” level during Tone/Pulse dialing and hold function. Otherwise, this pin stays “High impedance” level.
V_{DD} and V_{SS}	Positive and negative power supply input pins. Recommended operating voltage from 2.0Vdc to 5.5Vdc.
$\overline{\text{HFI}}$	Handfree inputs pin which accepts falling edge signal to turn “on” or turn “off” handfree function. This pin is hysteresis input structure and built-in pull up resistor (typically 200 Kohms).
HFO	Handfree outputs pin that is designed to control telephone line for on-hook dialing or control speakerphone circuit for handfree conversation. When handfree function is executed, this pin will switch to “High”. Otherwise, this pin stays “Low” level.
DTMF	The DTMF (Dual Tone Multi-Frequency) and music signals output pin. Normally, this pin stays “Low” level. In Tone dialing mode, this pin will output DTMF signal that is corresponding to keyboard 0 .. 9, * and # keys. Beside this, in the line hold duration, this pin will issue dual-tone music for telephone line.



Symbol	Function
$\overline{\text{HKS}}$	Control signal inputs pin that is corresponding hook switch status. When handset was left from cradle, this pin must be connected to “Low” level to operate all functions. Otherwise, this pin must be connected to “High” level to disable all function and prevent power consumption.
$\overline{\text{PO}}$	Pulse signal outputs pin that is NMOS open-drain output structure. Normally, this pin stays “High impedance” level. In Pulse dialing mode and keypad was entry. This pin will output pulse trains signal that is corresponding to keyboard 0 .. 9 keys.
HDO	Hold function output that is CMOS structure. Normally, this pin stays “Low” level. When Hold function is executing, this pin will output “High” level. This pin is designed to drive LED or peripheral circuit to indicate line is at Hold status.
SDO	SDO function output that is NMOS open-drain structure. When there is a valid entry on keyboard, this pin will output a serial data. This serial data is designed to drive LCD driver to display dialing number on LCD screen or drive voice synthesizer to announce dialing number to speaker.
$\overline{\text{DRING}}$	The ring signal detect input pin which is internal pull up (built-in 100 Kohms resistor). While the Tel-ring is incoming, this pin must be connected to “Low” with delay to indicate the ringing . Otherwise, this pin must be connected to “High” level .
$\overline{\text{RMUTE}}$	Ring mute output pin that is NMOS open-drain structure. The $\overline{\text{RMUTE}}$ pin is designed to control microphone of handset to prevent the illegal dialing from pocket dialer. If the $\overline{\text{DRING}}$ pin is at “High” level , then Off-Hook or turn on Handfree , this pin will output “Low” level. In other words, the $\overline{\text{DRING}}$ pin is used to check the phone that receives an incoming call ($\overline{\text{DRING}}$ =Low input) or make an outgoing call ($\overline{\text{DRING}}$ = High input) . If the phone user make an outgoing call ,then $\overline{\text{RMUTE}}$ pin activated to prevent the illegal dialing from pocket dialer in the particular application. The $\overline{\text{RMUTE}}$ can be restored to “High” level when the first key entry is not the optioned lock-number .

FUNCTION DESCRIPTIONS

Dialing signal selection

The EM91415 series incorporated a special keyboard scanning function that is connecting a resistor (typically is 560 Kohms) on keyboard scan pin to select many telephone specifications. The specifications are described as following :

a. Mode

ROW1	Mode
R-Vdd	20 PPS
NR	Tone
R-Vss	10 PPS

b. M/B ratio

ROW2	MBR (%)
NR	40:60
R-Vss	33:66

c. Flash time

ROW3	ROW4	Tf (ms)
NR	NR	600
NR	R-Vss	100
R-Vss	NR	80
R-Vss	R-Vss	300

d. Lock control method

COL1	Control method
R-Vdd	key lock
NR	none lock
R-Vss	password lock

e. Lock number

COL2	COL3	Lock number
NR	NR	none
NR	R-Vss	0
R-Vss	NR	9
R-Vss	R-Vss	0.9

f. ROW5/SDO pin functions

COL5	ROW5 or SDO Pin
NR	SDO
R-Vss	ROW5

(Note): If select SDO function, the memory type is (1T*3+2T*10)
 If select ROW function, the memory type is (1T*3+2T*10) and (1T*13)

Normal dialing

Directly keying digital key on keyboard which number can be dialing output and stored in LNB memory automatically. Operating procedure described as follow :

- To select Pulse or Tone mode.
- Off-hook or turn on HF function.
- Keying d1, d2, .. , dn. The “d” expressed digital keypad that included 1~9, *, 0, #, P, and P→T keys. The “n” expressed unlimited.
- The numbers d1, d2, .. , dn will be dialed out in Pulse or Tone mode as selection.

LNB redial memory

Storing:

In normal dialing mode, every digital key was entry which number will be stored in LNB memory automatically. If entry digits are more than 32 digits, the redial function of LNB memory will be disabled. Otherwise, these numbers stored in LNB memory can be redial output.



Redialing:

After normal dialing, directly keying **F** key (or On-Off hook once) and keying **RD** key on keyboard. The numbers that are stored into LNB memory will be dialed output.

Repertory memory

The EM91415 series incorporated several sets repertory memory and each one can store number up to 16 digits. In memory storing, if stored numbers are more than 16 digits that only the previous 16 digits can be stored into specific memory. Otherwise, these numbers can be stored entirely. After memory dialed out, the content of LNB is keeping to current data.

Storing of 13 sets memory types

Direct (one-touch) operation

Off-hook (or turn on HF function), push **(ST, d1, d2, .. , dn [ST], EMn or M1~M10 (ROW5 optioned))**. The numbers d1, d2, .. , dn will be stored into memory location “EMn” or Mn. The “EMn” expressed emergency memory EM1 to EM3. The Mn expressed memory M1~M10.

Indirect (two-touch) operation

Off-hook (or turn on HF function), push **(ST, d1, d2, .. , dn, ST, n)**. The numbers d1, d2, .. , dn will be stored into memory location “n”. The “n” expressed digital key from 0 to 9.

Dialing (after memory dialed out, the content of LNB is keeping to current data)

Direct (one-touch) memory operation

- To select Pulse or Tone mode.
- Off-hook (or Turn on HF function), push **Mn** (or **EMn**) key. The numbers that are stored in direct memory location “Mn (or EMn)” will be dialed out in Pulse or Tone mode as selection. The “n” expressed digital number from 1~10 decided by dialers’ memory sets.

Indirect (two-touch) memory operation

- To select Pulse or Tone mode.
- Off-hook (or Turn on HF function), push **A, n** key. The numbers that are stored in indirect memory location “n” will be dialed out in Pulse or Tone mode as selection. The “n” expressed digital key from 0 to 9.

Pause (P) key operation

The Pause (P) key is designed to support pause operation in dialing duration. “P” key can be stored in memory and it will occupy one digital position.

- To select Pulse or Tone mode.
- Off-hook (or turn on HF function), push **(d1, d2, .. , dn, RD/P, k1, k2, .. , kn)**. These numbers will be dialed out as following sequence:

d1, d2, .. , dn, Tp, k1, k2, .. , kn.



Pulse to Tone (*T) key operation

The Pulse to Tone (*T) key is designed to support toll dialing (long distance call) or PABX system operation. The “*/T” key can be stored in memory and it will occupy one digital position.

- To select Pulse mode.
- Off-hook (or turn on HF function), push d1, d2, .. , dn, */T, k1, k2, .. , kn. These numbers will be dialed out as following sequence:

d1, d2, .. , dn, Tpt, k1, k2, .. , kn.
(pulse mode) (tone mode)

Flash (F) key operation

The Flash (F) key is designed to break telephone line temporarily. After F key is depressed, this dialer will send a flash signal to break line 600 ms, 300 ms, 100 ms or 80 ms as ROW3 and ROW4 selection.

Handfree (HF) function

The handfree function is designed to support on-hook dialing and loudspeaker application which can be turn “on” or “off” with falling edge signal from $\overline{\text{HFI}}$ pin. During handfree function is executed, the HFO pin is switched to “high”. Otherwise the HFO pin stays “low” level. One of the following operations can turn off Handfree function (HFO pin return to “Low”).

- On-off hook once.
- Trigger $\overline{\text{HFI}}$ pin with falling edge signal.
- Turn on Hold (HD) function. (HDO pin switched to “High”)

Hold (HD) function

The Hold function is designed to stop conversation temporarily. In off-hook state (or HF function is turned on), to press **HD** key on the keyboard, the Hold function can be turned “on” (HDO pin switched to “High”). One of the following operations can turn off Hold function (HDO pin switched to “Low”).

- On-off hook once.
- To press **HD** key over 280 ms.
- Turn on Handfree (HF) function. (HFO pin switched to “High”)

Special Note:

A 300 ms delay time (Tdly) at the first Off-Hook or turn on Handfree that is a special designed to avoid a rapid key entry (dummy number) in this time duration, and a long distance call number follows. For example, Off-Hook, “3”,, “0”, 1,2,3.....

Dummy key Lock number key

The dummy number “3” is not detected by the centered office or PABX, but the following numbers “0”, 1,2,3... long distance call can be dialed out normally since the leading number “3” is not the Lock-number defined in EM91415 series. To prevent the unavoidable long distance call, then EM91415 inhibits the key entry during Tdly.

Operating flow chart

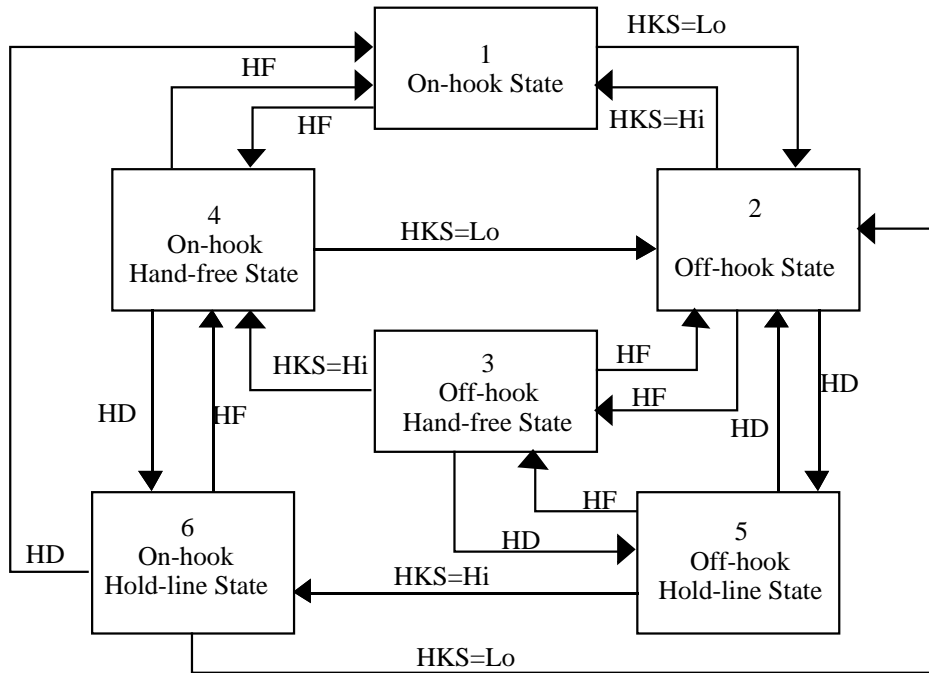

<Note> : HF = Handfree
 HD = Hold

Truth table

Operating state	Input/Output pin level				
	HKS	PO	XMUTE	HFO	HDO
(0) On-hook, idle state	H	F	F	L	L
(1) Off-hook line	L	F	F	L	L
(2) Off-hook, HF line	L	F	F	H	L
(3) On-hook, HF line	H	F	F	H	L
(4) Off-hook, HD line	L	F	L	L	H
(5) On-hook, HD line	H	F	L	L	H

Note : F=floating (high impedance); H=logic “High”; L=logic “Low” level.

Music on Hold

EM91415 series built-in a melody generator to generate dual-tone music on DTMF output pin. The music is designed for telephone line at line holding.

SDO (Serial Data Output) function

The SDO is serial data output which format is same as UART protocol. SDO function is designed to drive LCD driver and voice synthesizer. So the dialing numbers can be display on LCD screen with EM32100 (or EM32116). The SDO signal consists of two start bits, six data bits and two stop bits. Each bit time is about 3.9 ms (256 Hz) and output sequences are following by start bits, data bits (LSB to MSB) and stop bits.

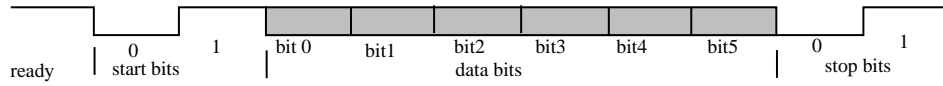

SDO Keypad Encoded table:

◆ Digital key (b5,b4=0,0)

keypad	1	2	3	4	5	6	7	8	9	0	“*/T	#	P	*/T”
output b3,b2,b1,b0	0001	0010	0011	0100	0101	0110	0111	1000	1001	1010	1011	1100	1101	1110
Display	1	2	3	4	5	6	7	8	9	0	┌	┐	P	└

◆ Function key (b5,b4=1,0)

keypad	F
output b3,b2,b1,b0	1111
Display	clear all display

* Keypad,SDO format and LCD display reference table:

Keypad	bit5	bit4	bit3	bit2	bit1	bit0	Display
1	0	0	0	0	0	1	1
2	0	0	0	0	1	0	2
3	0	0	0	0	1	1	3
4	0	0	0	1	0	0	4
5	0	0	0	1	0	1	5
6	0	0	0	1	1	0	6
7	0	0	0	1	1	1	7
8	0	0	1	0	0	0	8
9	0	0	1	0	0	1	9
0	0	0	1	0	1	0	0
“*/T	0	0	1	0	1	1	┌
#	0	0	1	1	0	0	┐
P	0	0	1	1	0	1	P
*/T”	0	0	1	1	1	0	└
F	1	0	1	1	1	1	clear all display



LOCK function

The EM91415 series provide the LOCK function to inhibit toll dialing operation. Connecting a resistor on COL1 pin to VSS can select different LOCK control method that is conventional key lock or password lock. Also the lock number that can be selected by connecting the resistors on COL2 or COL3 pin. After power on reset, the password is fixed to 000 automatically. The lock function is disabled when the password is equal to 000 .

How to setup password

- Set LOCK function to password control mode. (Connects a resistor on COL1 pin to VSS)
- Off hook (or turn on HF function)
- Push : # , # , **ops1** , **ops2** , **ops3** , **nps1** , **nps2** , **nps3** , # . If the ops1~ops3 are the same with current password, then nps1~nps3 will be stored in the dialer to replace current password. Otherwise, the current password can not be updated. All the numbers pressed in the password setup procedure can not be dialed out when current password is not equal to 000. If the current password are equal to 000, then only the first number “#” will be dialed out.

Normal dialing :

Set lock function to none lock mode (without resistor connected to COL1 pin) or set password equal to 000. In this case, the dialer is operated in normal mode and all functions work at unlimitation.

Dialing via LOCK function

Conventional key lock mode. (Connects a resistor on COL1 pin to VDD)

- Off hook (or turn on HF function)
- Keying : d1 , d2 , ... , dn . If the first number (d1) is the same with the lock number that optioned in table, then all entry numbers can not be dialed out and keyboard will be inhibited until on to off hook once again. If the first number is not equal to lock number, all the entry numbers will be dialed out.

Password control mode. (Connects a resistor on COL1 pin to VSS)

- Off hook (or turn on HF function)
- Keying : ([# , **ps1** , **ps2** , **ps3**] + **telephone number**.) The numbers in the [] symbol could be omitted. The number “#” will be inhibited when the current password is not equal to 000, and **ps1** , **ps2** , **ps3** work at the checking state, not to be dialed out. Other descriptions are as on following :
 - ◇ **Incorrect password entry**. The telephone numbers can not be dialed out.
 - ◇ **Password is omitted** . If the first digit of telephone numbers is the same with the lock number, all of the telephone numbers can not be dialed out and keyboard will be inhibited until On to Off hook once again. If the first digit is not equal to the lock number then the telephone numbers will be dialed out entirely.
 - ◇ **Correct password entry**. The telephone numbers can be dial out no matter what lock number is.

Ring detector

The Ring detector is designed to prevent illegal dialing from pocket dialer. Following the procedures (i,ii,iii), this dialer will detect $\overline{\text{DRING}}$ pin to control $\overline{\text{RMUTE}}$ output level. If $\overline{\text{DRING}}$ is detected a “Low” level, the $\overline{\text{RMUTE}}$ stays “High impedance”. If $\overline{\text{DRING}}$ is detected a “High” level, the $\overline{\text{RMUTE}}$ will output “Low” until



keyboard entry. In actual application of the $\overline{\text{RMUTE}}$ pin is recommended connection to microphone of the phone handset to prevent that the dialing signal (DTMF) is coupling by the Microphone of the phone handset. (such as pocket dialer)

- i. In idle state, $\overline{\text{HKS}}$ is from “High” to “Low” (pick up handset action).
- ii. In idle state, turn on handfree function.
- iii. The flash operation (F key).



ABSOLUTE MAXIMUM RATINGS(Ambient temperature is 25 °C, all voltages referenced to V_{SS})

Items	Sym.	Rating	Unit
Power supply voltage	V_{DD}	6.0 Vdc	V
Input voltage range	V_{IN}	$V_{SS}-0.3V \sim V_{DD}+0.3V$	V
Operating temperature	T_{OPR}	0 ~ +50	°C
Storage temperature	T_{STO}	-55 ~ 125	°C
Power consumption	P_D	500	mW

ELECTRICAL CHARACTERISTICS

(Ambient temperature is 25 °C, $V_{DD}=2.5V$ unless otherwise noted, all voltages referenced to V_{SS} , $F_{osc}=3.579545$ MHz)

Parameter	Sym.	Min.	Typ.	Max.	Unit	Condition	
Operating voltage	Pulse	2.0	-	5.5	V	unload	
	Tone	2.0	-	5.5			
Operating current($\overline{HKS}=0$)	Pulse	-	0.15	0.3	mA	unload with pull up/down resistor * 8	
	Tone	-	0.3	0.5			
	Pulse	-	0.15	0.3			
	Tone	-	0.3	0.5			
Memory retention current		I_{mrt}	-	0.001	0.1	uA	$\overline{HKS}=1, V_{DD}=1V$
Standby current	$\overline{HKS}=1$	I_{stby}	-	0.001	0.1	uA	unload
	$\overline{HKS}=0$		-	1	10		
	$\overline{HKS}=1$		-	-0.001	0.1		with pull up/down resistor * 8
	$\overline{HKS}=0$		-	10	30		
\overline{HFI} , \overline{HFI} & \overline{DRING} pins: input voltage	V_{iH}	0.8V _{DD}	-	V _{DD}	V		
	V_{iL}	V _{SS}	-	0.2V _{DD}			
\overline{HFO} & \overline{HDO} pins source current	I_{oH}	0.2	-	-	mA	$V_o = 2.0 V$	
\overline{PO} , \overline{HFO} , \overline{XMUTE} , \overline{RMUTE} & \overline{SDO} pins: sink current	I_{oL}	-0.2	-	-	mA	$V_o = 0.5 V$	
\overline{PO} , \overline{XMUTE} , \overline{RMUTE} and \overline{SDO} pins: leakage current	I_{oH}	-	-	±0.001	uA	$V_o = V_{DD}$	
\overline{HFI} pin input resistance	R_{hfi}	-	200	-	KΩ	$V_{hfi} = V_{SS}$	
\overline{DRING} pin input resistance	R_{dring}	-	100	-	KΩ	$V_{deing}=V_{SS}$	
Keyboard scanning pins output current (except COL4/KT)	I_{oH}	2	10	50	uA	$V_{ksn}=V_{SS}$	
	I_{oL}	200	400	800	V	$V_{ksn}=V_{DD}$	
COL4/KT source current sink current	I_{oH}	0.2	-	-	mA	$V_o=2.0V$	
	I_{oL}	0.2	-	-		$V_o=0.5V$	



ELECTRICAL CHARACTERISTIC

(Ambient temperature is 25°C, $V_{DD}=2.5V$ unless otherwise noted, all voltages referenced to V_{SS} , $F_{osc}=3.579545$ MHz)

Parameter	Sym.	Min.	Typ.	Max.	Unit	Condition
Keyboard debounce time	Tdb	-	20	-	ms	
Key tone signal: frequency	Fkt	-	600	-	Hz	
duration	Tkt	-	30	-	ms	
Pause time	Tp	-	3.6	-	sec.	
Pulse to Tone waiting time	Tpt	-	3.6	-	sec.	
Flash time	Tf	-	600	-	ms	Row3B, Row4B=NR, NR
		-	100	-		Row3B, Row4B=NR, R-Vss
		-	80	-		Row3B, Row4B=R-Vss, NR
		-	300	-		Row3B, Row4B=R-Vss, R-Vss
Pulse rate	PSR	-	20	-	pps	Row1 = R-Vdd
		-	10	-		Row1 = R-Vss
Make/Break ratio	MBR	-	40:60	-	%	Row2 = NR
		-	33:66	-		Row2 = R-Vss
Inter-digit pause time	Tidp	-	800	-	ms	PSR = 10 pps
		-	500	-		PSR = 20 pps
DTMF pin: sink current	IoL	-0.2	-	-	mA	Vdtmf = 0.5 V
DTMF signal DC level	Vdc	0.5	-	0.75	Vdd	Vdd = 2.0V ~ 5.5V
DTMF signal: ac level	Vdtmf	142	160	180	mVrms	Row group
pre-emphase	Twist	1	2	3	dB	Column - Row
distortion	THD	-	-30	-23	dB	RL = 5 KΩ
load resistance	ZL	5	-	-	KΩ	THD < - 23dB
Minimum tone duration	Tp	96	98	100	ms	
Minimum inter-tone pause	Titp	96	98	100		Memory dialing
Melody output signal: main tone ac level	Vmtac	48	(-23.3)	53	(dBm)	Vdd = 2.0V ~ 5.5V
Sub-tone			37		(-25.3)	
	Vstac				47	mVms
HD key release hold function debounce time	Thdrdb	-	280	-	ms	
SDO every bit time	Tbit	3.8	3.9	4.1	ms	
Off-Hook delay time	Tdly	-	300	-	ms	



DTMF output frequency ($f_{osc} = 3.579545$ MHz)

Keyboard scan pin	CCITT standard (Hz)	Actual output (Hz)	Deviation (%)
ROW1 (f1)	697	699.1	0.30
ROW2 (f2)	770	766.2	0.49
ROW3 (f3)	852	847.4	-0.53
ROW4 (f4)	941	947.9	0.73
COL1 (f5)	1209	1215.8	0.56
COL2 (f6)	1336	1331.6	-0.32
COL3 (f7)	1477	1471.8	-0.35

TIMING DIAGRAM

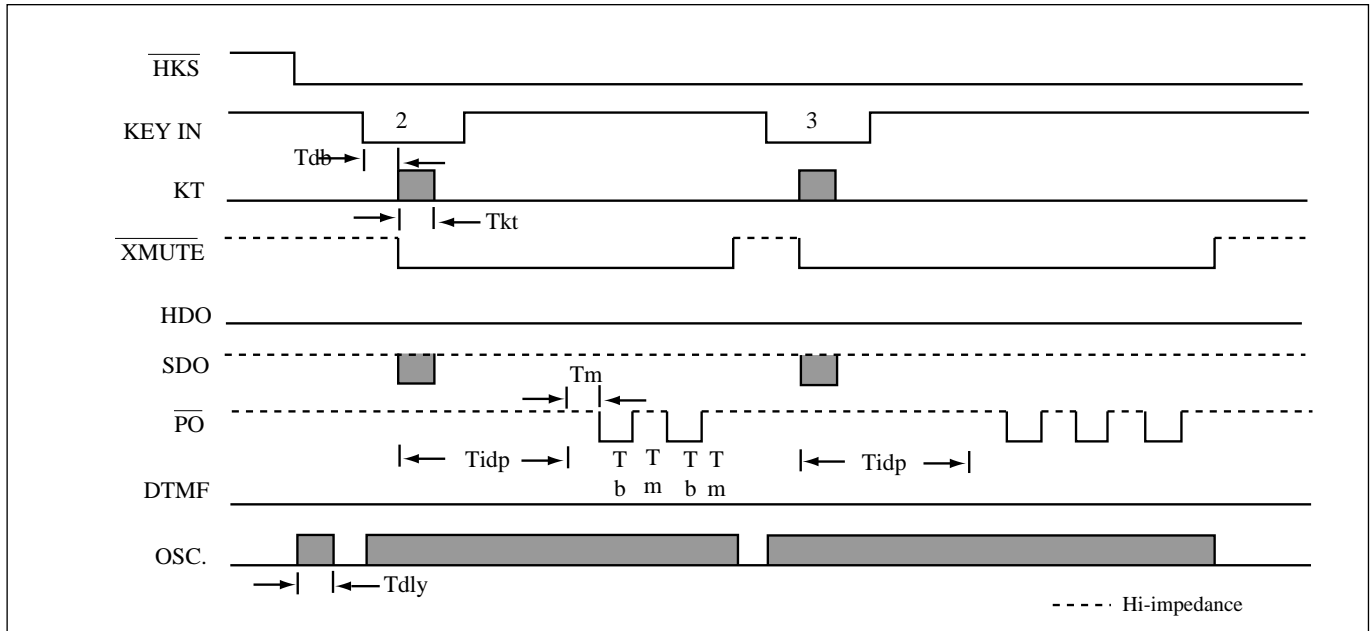

Figure 1. Pulse mode operating timing

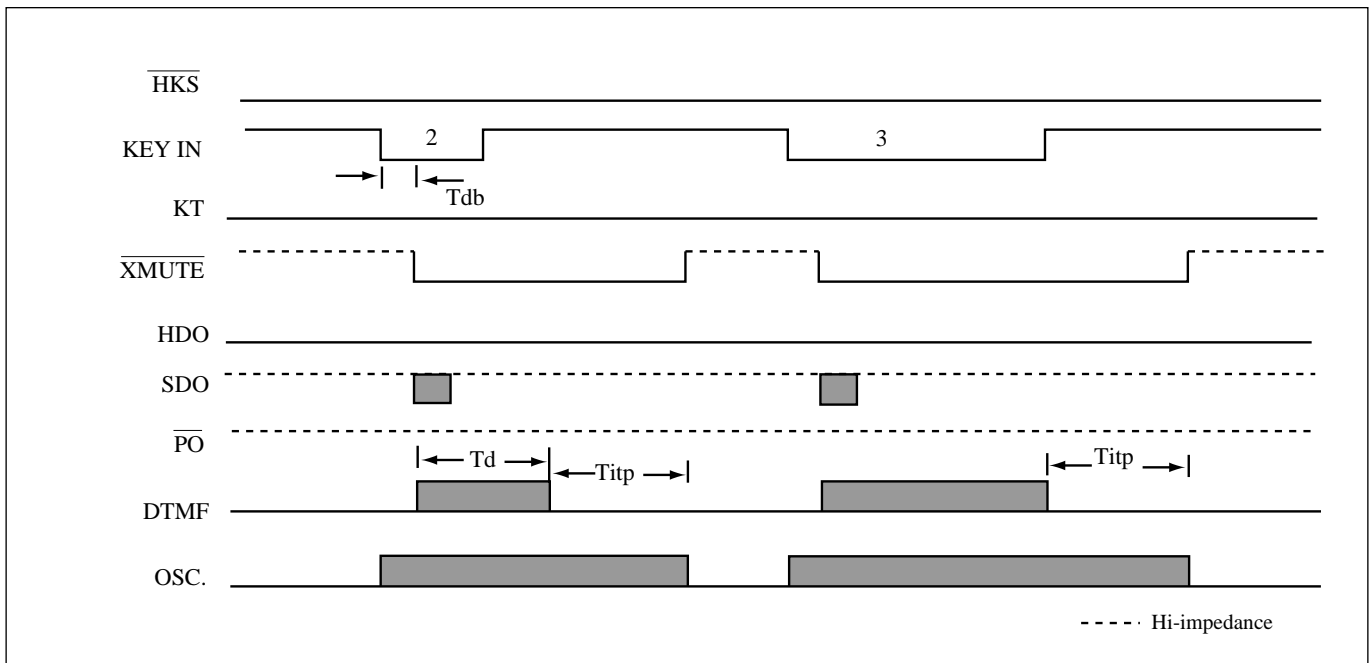

Figure 2. DTMF mode operating timing

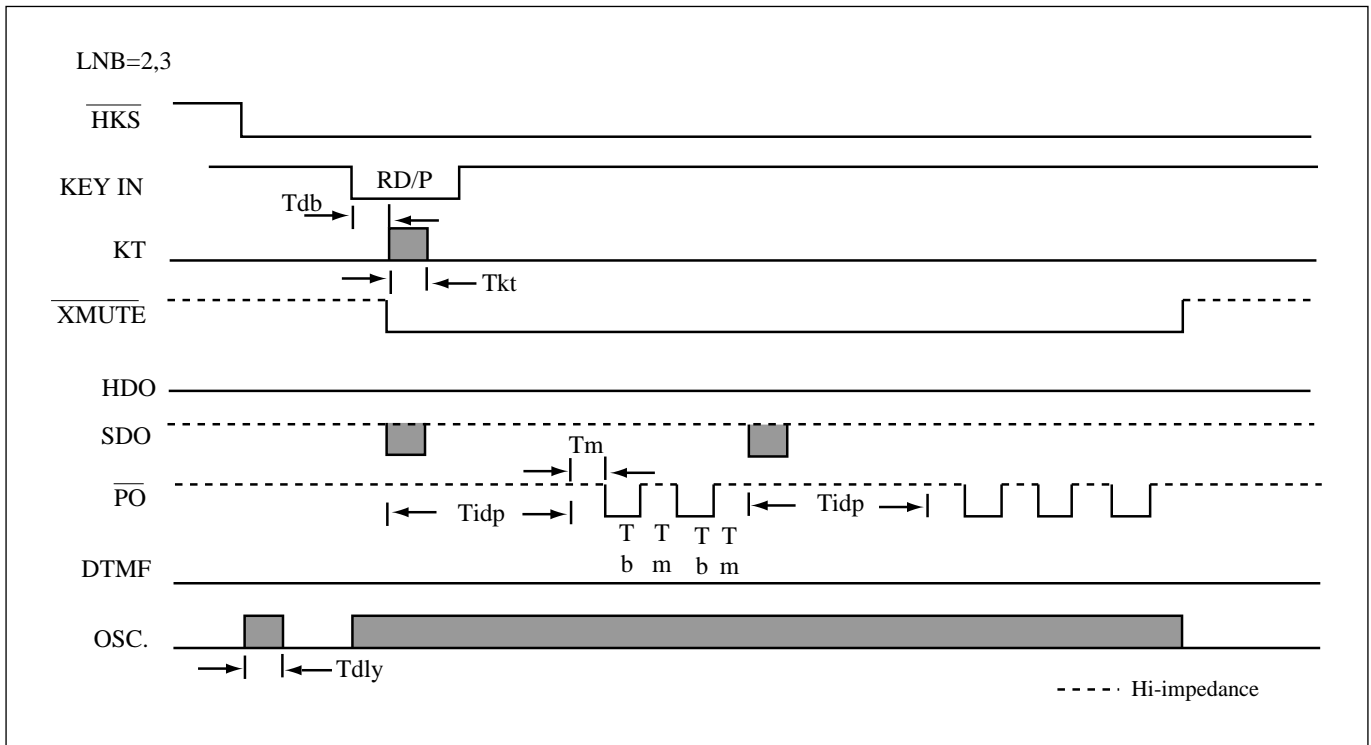

Figure 3. Pulse mode LNB redial timing

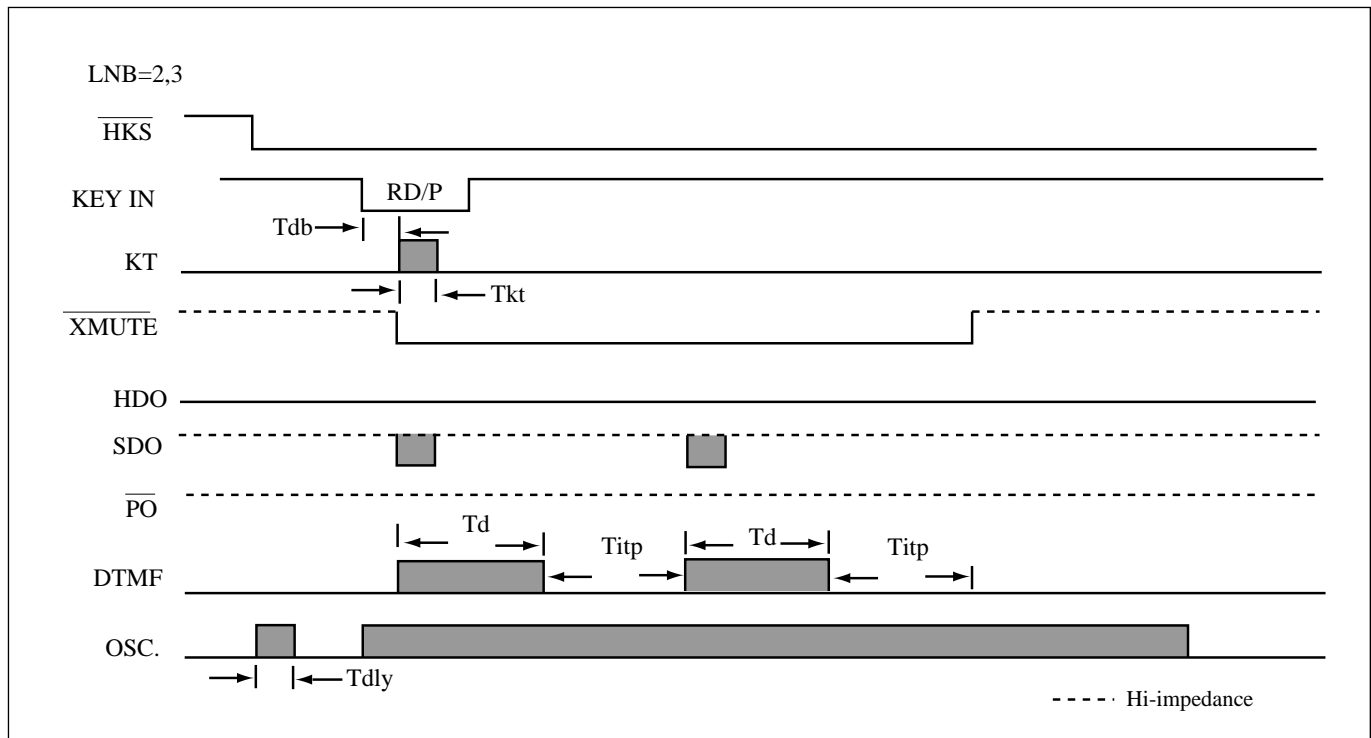

Figure 4. DTMF mode LNB redial timing

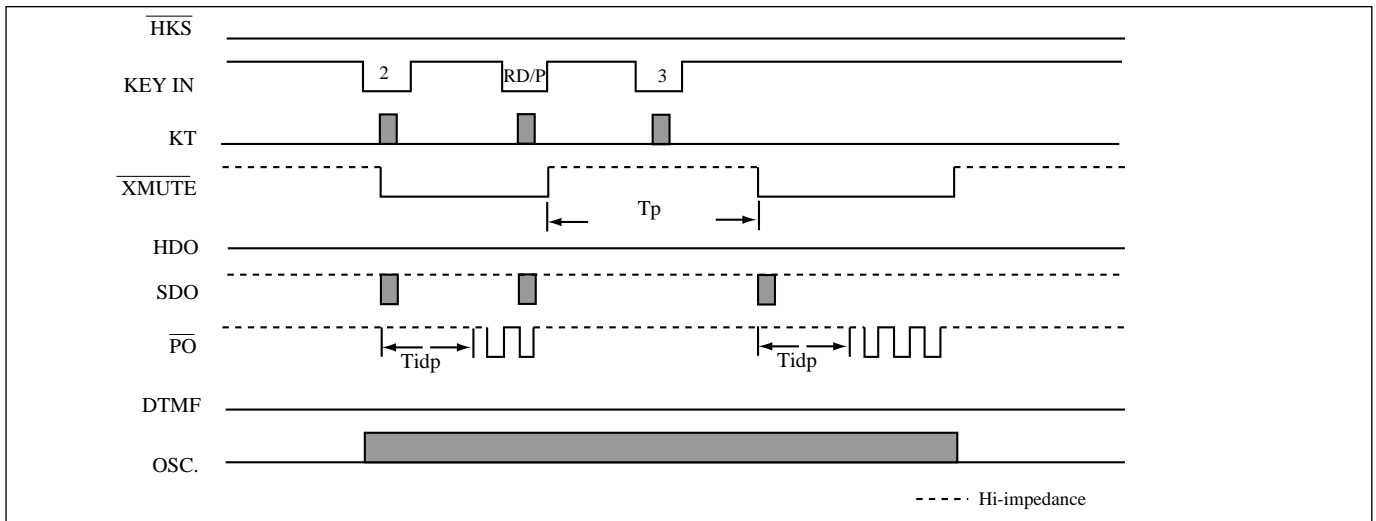

Figure 5. Pause key operating timing

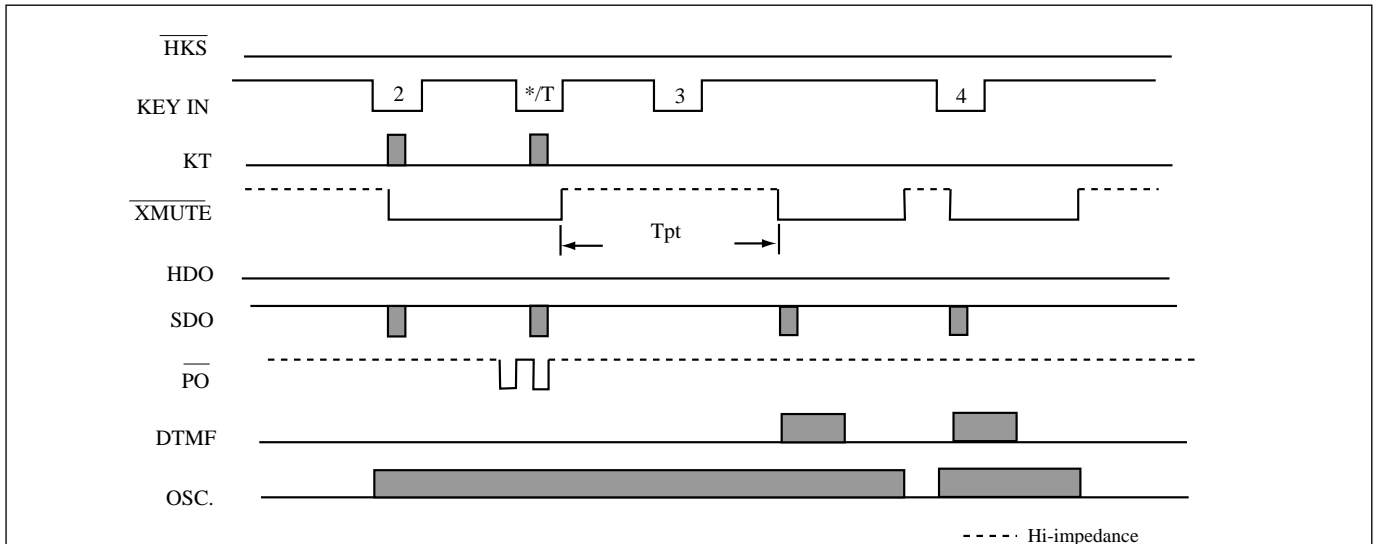

Figure 6. Pulse to Tone (P→T) operating timing

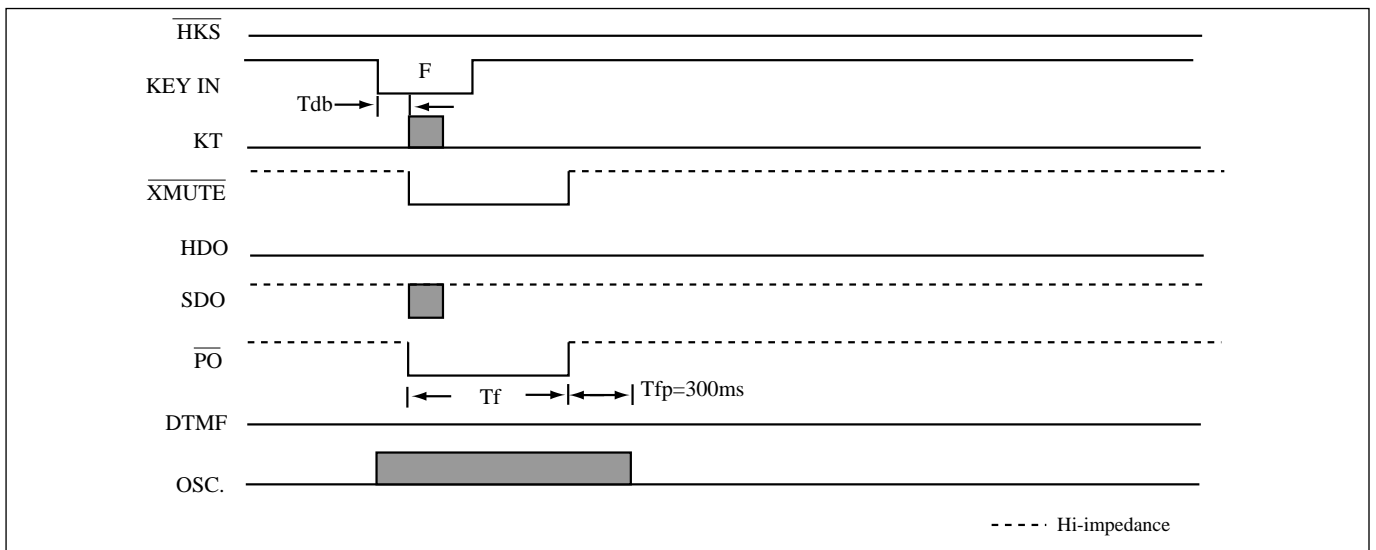
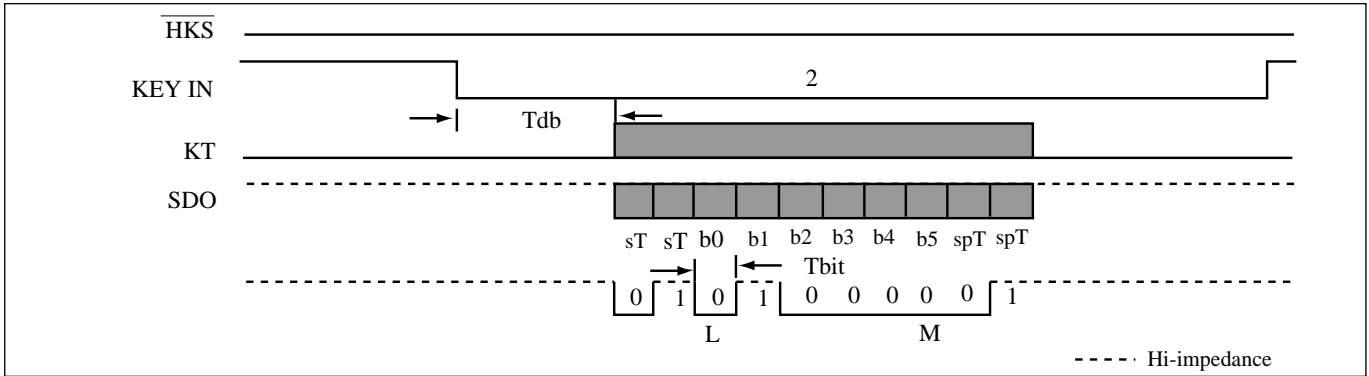
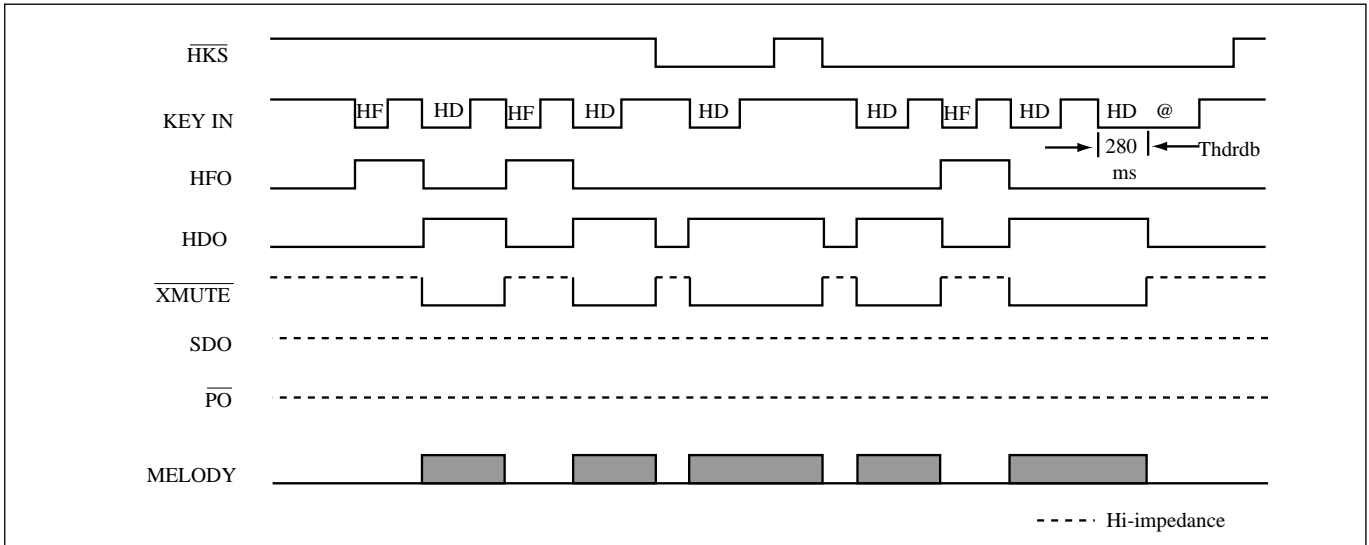

Figure 7. Flash key operating timing



<Note>L=LSB,M=MSB, sT=START bit time, spT=STOP bit time

Figure 8. SDO operating timing



@ : It can be triggered by extension telephone set for hold function release

Figure 9. HF and HD operating timing

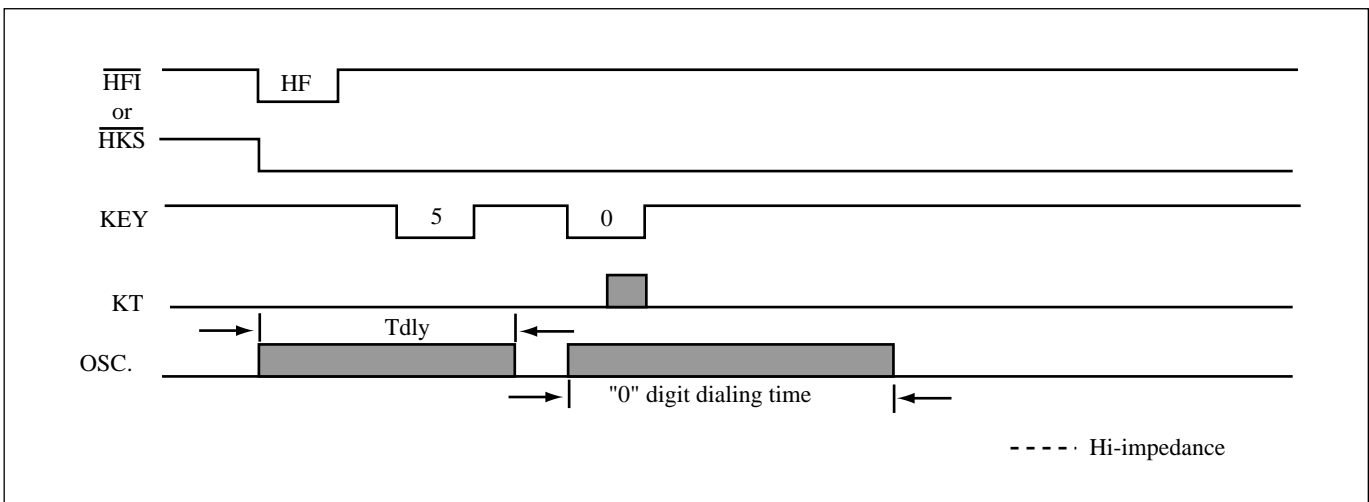

Figure 10. Off-Hook delay time

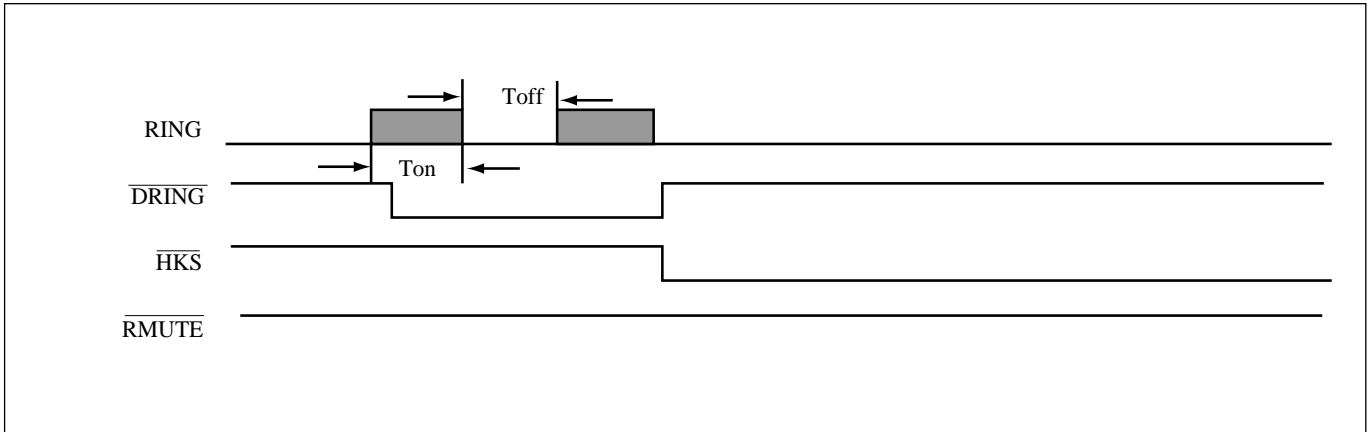

Figure 11. Timing of receiving an incoming call

* The external ring detection circuit must send a low signal at the total ring cycle (Ton and Toff)

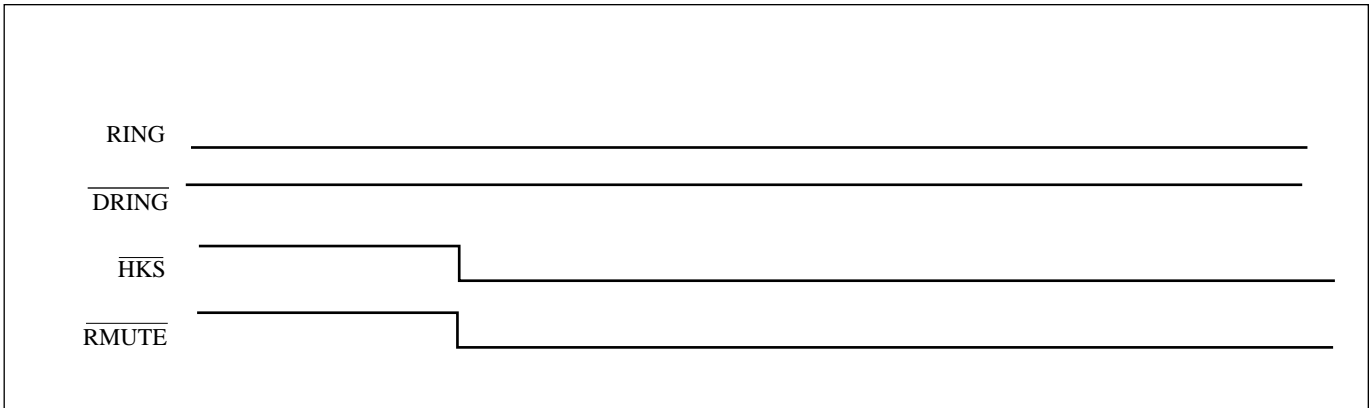
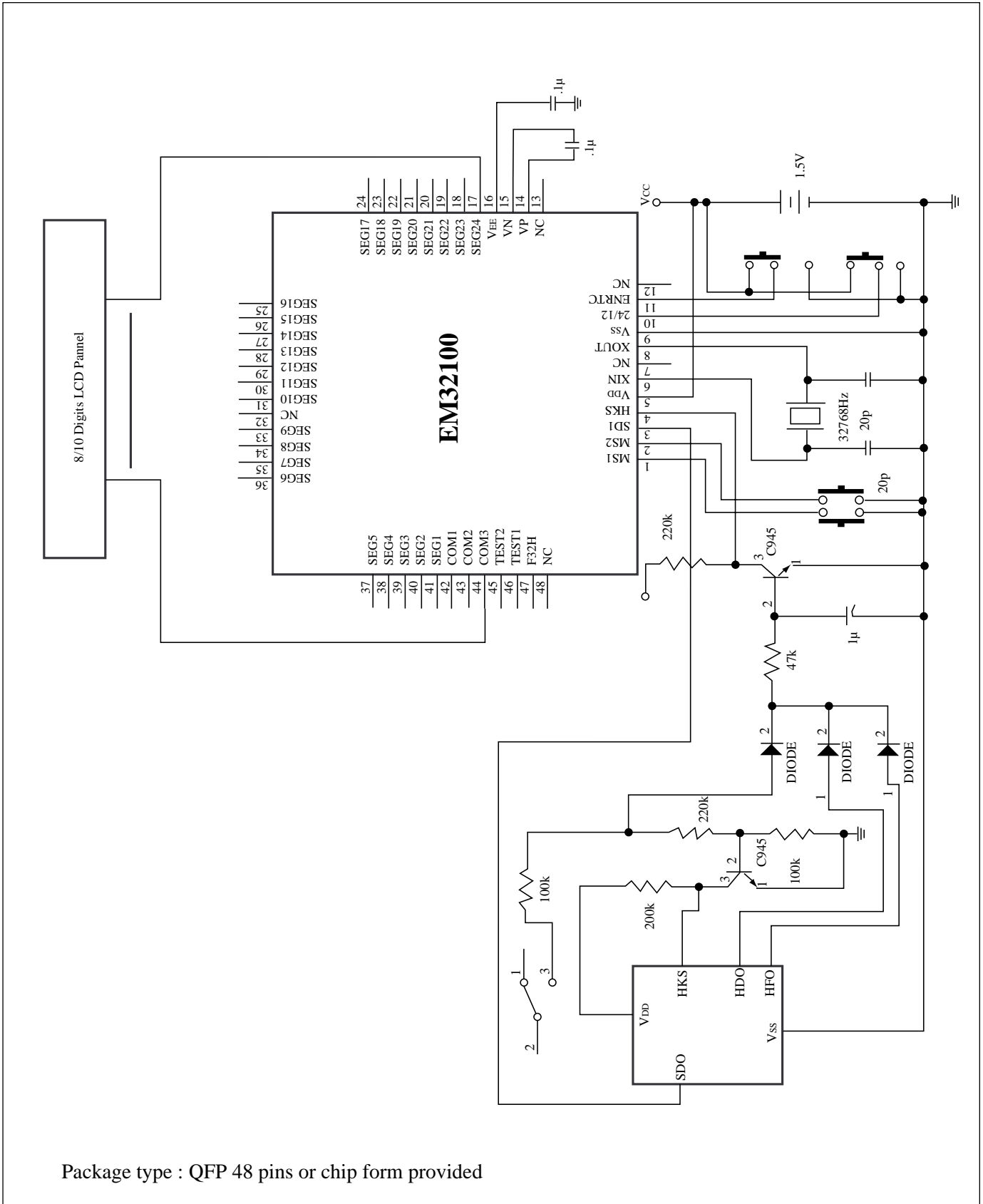

Figure 12. Timing of making an outgoing call

EM32100 Application Circuit :



Package type : QFP 48 pins or chip form provided

EM32116 Application Circuit :

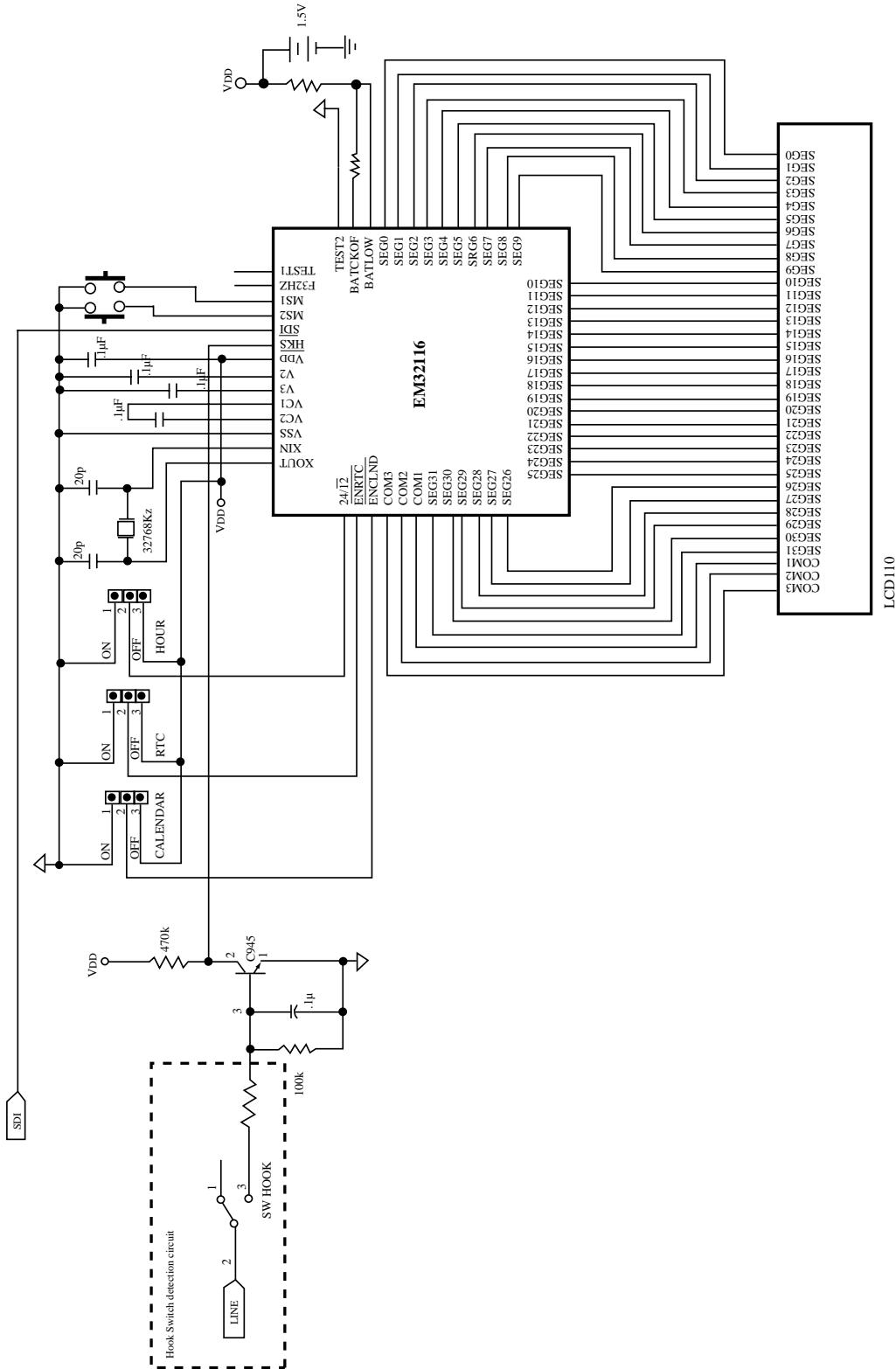

Package type : QFP 64 pins or chip form provided

PACKAGE INFORMATION

Example :

EM 914XX P
 (1) (2) (3)

- (1) ELAN MICRO. prefix
- (2) Type number
- (3) Package code:
 P→PDIP
 K→Skinny
 R→SDIP

18/20/28 Lead Plastic Package

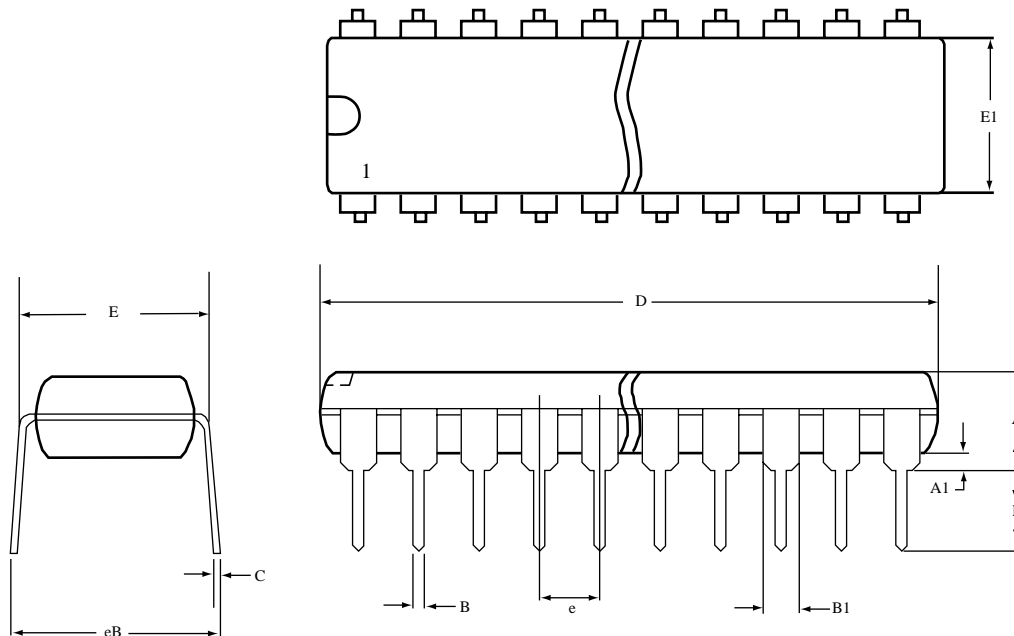

18 PDIP					20 PDIP					28 PDIP				
DIM	MILIMETERS		INCHES		DIM	MILIMETERS		INCHES		DIM	MILIMETERS		INCHES	
	MIN.	MAX.	MIN.	MAX.		MIN.	MAX.	MIN.	MAX.		MIN.	MAX.	MIN.	MAX.
A	-	5.334	-	.210	A	-	5.334	-	.210	A	-	6.350	-	.250
A1	0.381	-	.015	-	A1	0.381	-	.015	-	A1	0.381	-	.015	-
B	0.356	0.558	.014	.022	B	0.356	0.558	.014	.022	B	0.356	0.558	.014	.022
B1	1.150	1.778	.045	.070	B1	1.150	1.778	.045	.070	B1	1.016	1.778	.040	.070
C	0.204	0.381	.008	.015	C	0.204	0.381	.008	.015	C	0.204	0.381	.008	.015
D	22.35	23.37	.880	.920	D	25.40	26.67	1.000	1.050	D	35.56	37.85	1.400	1.490
E	7.620	8.255	.300	.325	E	7.620	8.255	.300	.325	E	15.24	15.88	.600	.625
E1	6.096	7.112	.240	.280	E1	6.096	7.112	.240	.280	E1	13.21	14.73	.520	.580
e	2.286	2.794	.090	.110	e	2.286	2.794	.090	.110	e	2.286	2.794	.090	.110
eB	-	10.92	-	.430	eB	-	10.92	-	.430	eB	-	17.78	-	.700
L	2.921	4.064	.115	.160	L	2.921	4.064	.115	.160	L	2.921	5.080	.115	.200

22/24 Lead Plastic Package-Skinny

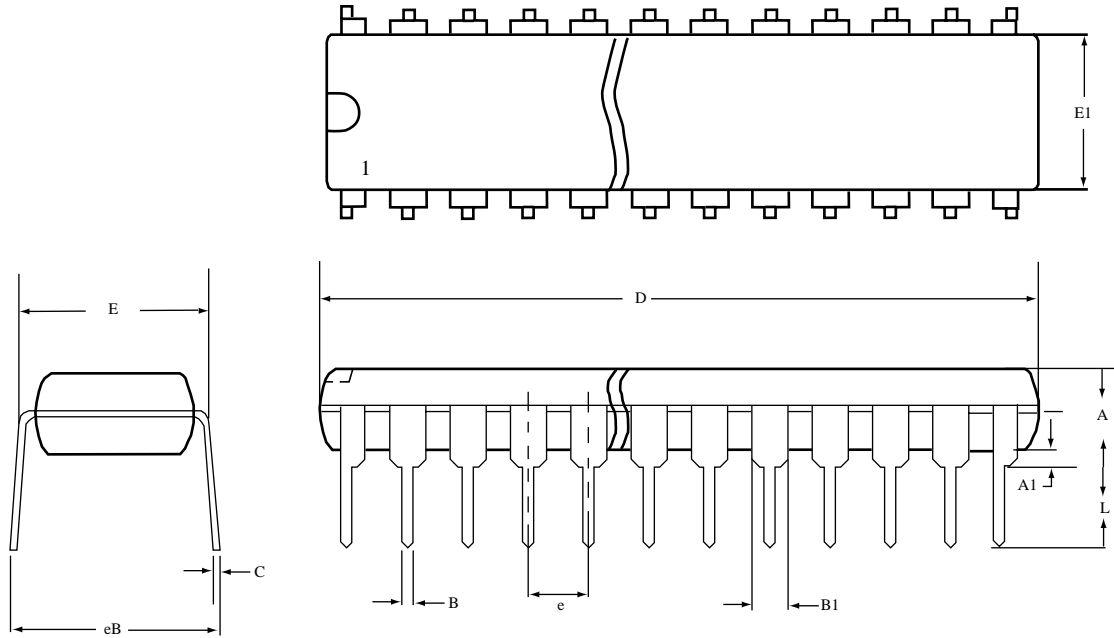

22 PDIP (skinny)					24 PDIP (skinny)				
DIM	MILIMETERS		INCHES		DIM	MILIMETERS		INCHES	
	MIN.	MAX.	MIN.	MAX.		MIN.	MAX.	MIN.	MAX.
A	-	4.752	-	.180	A	-	4.572	-	.180
A1	0.381	-	.015	-	A1	0.381	-	.015	-
B	0.356	0.558	.014	.022	B	0.356	0.558	.014	.022
B1	1.27	1.778	.050	.070	B1	1.27	1.778	.050	.070
C	0.204	3.556	.008	.014	C	0.204	0.381	.008	.015
D	25.90	26.67	1.02	1.05	D	31.24	32.26	1.23	1.270
E	7.620	8.255	.300	.325	E	7.620	8.255	.300	.325
E1	6.223	6.604	.245	.260	E1	6.223	6.731	.245	.265
e	2.286	2.794	.090	.110	e	2.286	2.794	.090	.110
eB	8.382	10.16	.330	.400	eB	8.636	9.652	.340	.380
L	2.921	4.064	.115	.160	L	2.921	4.064	.115	.160

42 SDIP Package

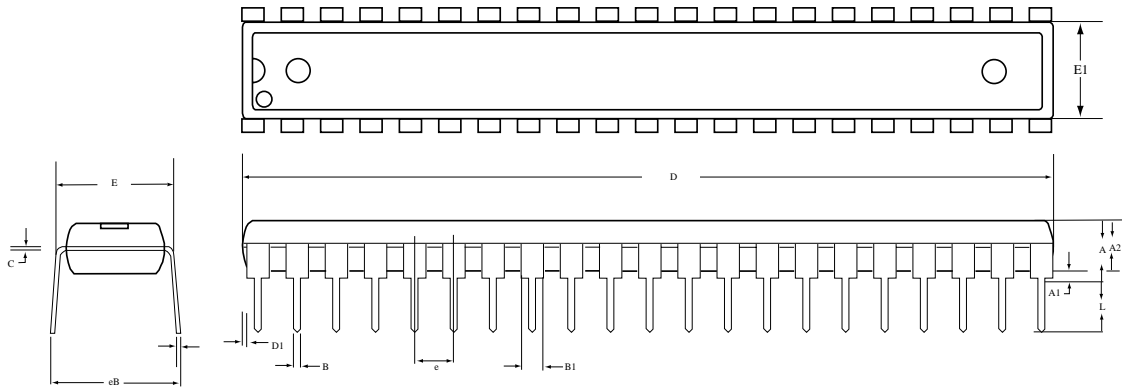

42 SDIP				
DIM	MILIMETERS		INCHES	
	MIN.	MAX.	MIN.	MAX.
A	-	5.08	-	0.200
A1	0.381	-	0.015	-
A2	3.937	4.191	0.155	0.165
B	0.356	0.559	0.014	0.022
B1	0.914	1.116	0.036	0.044
C	0.204	0.304	0.008	0.012
D	36.70	37.34	1.445	1.470
E1	13.84	14.10	0.545	0.555
e	1.727	1.829	0.068	0.072
eB	15.24	17.78	0.600	0.70
D1	0	0.127	0	0.005
L	2.921	3.429	0.115	0.135