

Features

- Glass Passivated Die Construction
- 400W Peak Pulse Power Dissipation
- 5.0V – 440V Standoff Voltage
- Uni- and Bi-Directional Versions Available
- Excellent Clamping Voltage
- Typical Response Time < 1nS
- Plastic Case Material has UL Flammability Classification Rating 94V-0

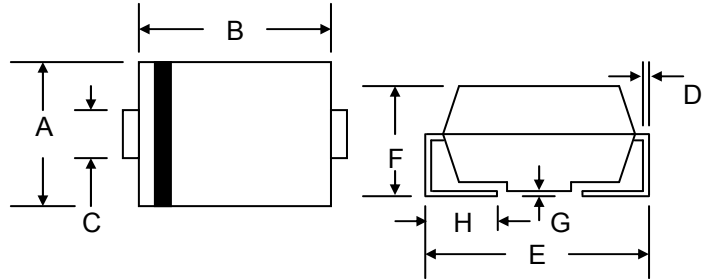

Mechanical Data

- Case: SMA/DO-214AC, Molded Plastic
- Terminals: Solder Plated, Solderable per MIL-STD-750, Method 2026
- Polarity: Cathode Band Except Bi-Directional
- Marking: Device Code
- Weight: 0.064 grams (approx.)
- **Lead Free: For RoHS / Lead Free Version, Add "-LF" Suffix to Part Number, See Page 6**

SMA/DO-214AC		
Dim	Min	Max
A	2.29	2.92
B	4.00	4.60
C	1.27	1.90
D	0.152	0.305
E	4.80	5.30
F	2.00	2.44
G	0.051	0.203
H	0.76	1.52
All Dimensions in mm		

Maximum Ratings and Electrical Characteristics @ $T_A=25^\circ\text{C}$ unless otherwise specified

Characteristic	Symbol	Value	Unit
Peak Pulse Power Dissipation on 10/1000 μs Waveform (Note 1, 2, 5)	PPPM	400	W
Peak Pulse Current on 10/1000 μs Waveform (Note 1)	IPPM	See Table 1	A
Peak Forward Surge Current (Note 2, 3)	IFSM	40	A
Maximum Instantaneous Forward Voltage at 25A (Note 3, 4)	V _F	3.5 / 5.0	V
Power Dissipation on Infinite Heatsink at $T_A = 50^\circ\text{C}$	P _D	3.3	W
Typical Thermal Resistance, Junction to Ambient (Note 2)	R _{JA}	120	$^\circ\text{C}/\text{W}$
Typical Thermal Resistance, Junction to Lead (Note 2)	R _{JL}	30	$^\circ\text{C}/\text{W}$
Operating and Storage Temperature Range	T _J , T _{STG}	-55 to +150	$^\circ\text{C}$

- Note:
1. Non-repetitive current pulse per Figure 5 and derated above $T_A = 25^\circ\text{C}$ per Figure 1.
 2. Mounted on 5.0 x 5.0mm copper pads to each terminal.
 3. Measured on 8.3ms single half sine-wave, duty cycle = 4 pulses per minute maximum. For uni-directional devices only.
 4. $V_F < 3.5\text{V}$ for $V_{BR} \leq 200\text{V}$ and $V_F < 5.0\text{V}$ for $V_{BR} \geq 201\text{V}$.
 5. Peak pulse power waveform is 10/1000 μs .

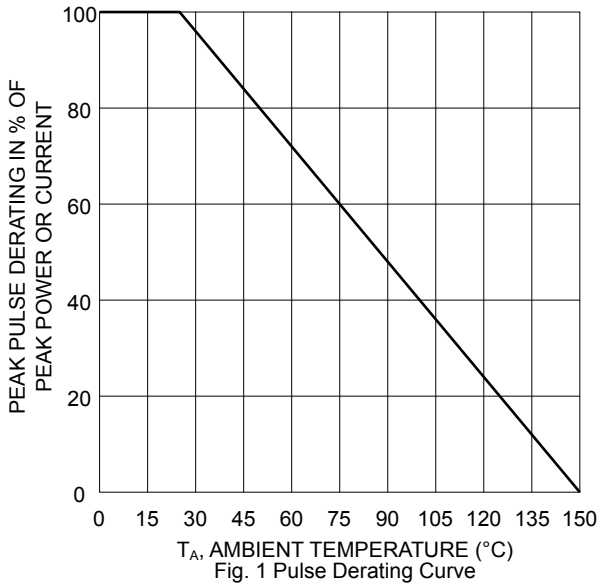

Fig. 1 Pulse Derating Curve

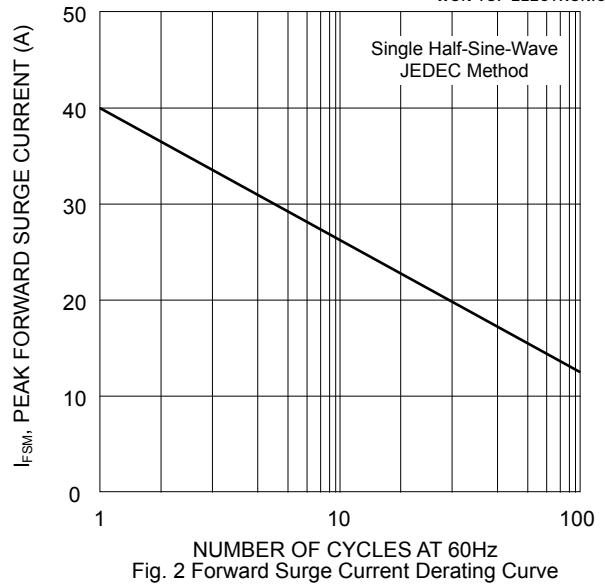

Fig. 2 Forward Surge Current Derating Curve

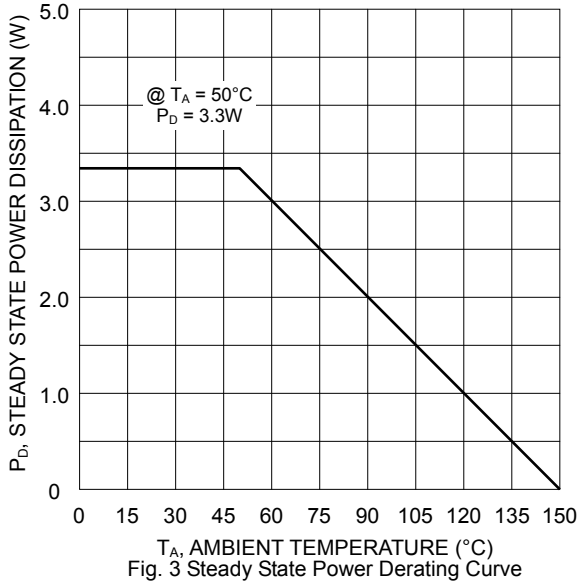

Fig. 3 Steady State Power Derating Curve

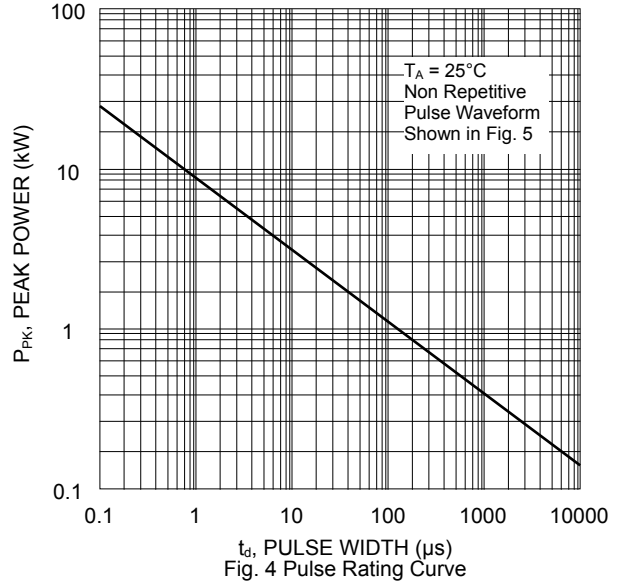

Fig. 4 Pulse Rating Curve

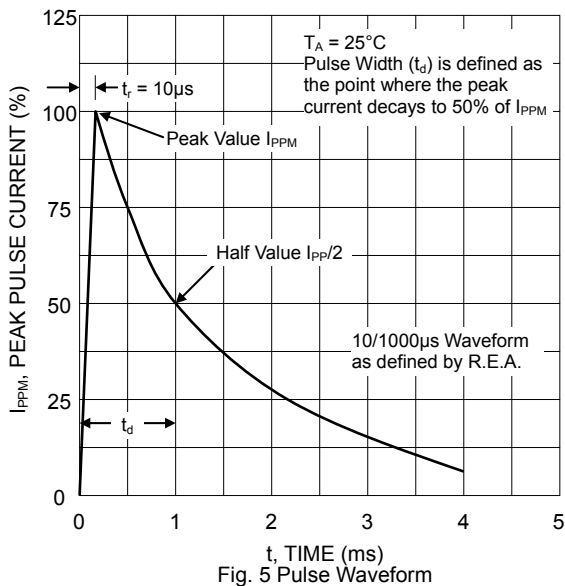

Fig. 5 Pulse Waveform

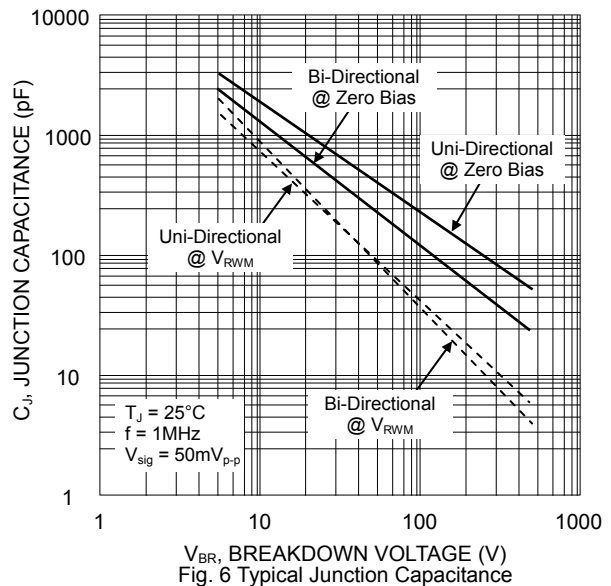

Fig. 6 Typical Junction Capacitance

Electrical Characteristics (@T_A=25°C unless otherwise specified) Table 1

Uni-Directional Part No.	Bi-Directional Part No.	Device Marking Code		Reverse Stand-Off Voltage V _{RWM} (V)	Breakdown Voltage V _{BR} (V) @I _T		Test Current I _T (mA)	Maximum Clamping Voltage @I _{PP} V _C (V)	Peak Pulse Current I _{PP} (A)	Reverse Leakage* @V _{RWM} I _R (μA)
		UNI	BI		Min.	Max.				
P4SMAJ5.0	P4SMAJ5.0C	HD	TD	5.0	6.40	7.30	10	9.6	41.67	800
P4SMAJ5.0A	P4SMAJ5.0CA	HE	TE	5.0	6.40	7.00	10	9.2	43.48	800
P4SMAJ6.0	P4SMAJ6.0C	HF	TF	6.0	6.67	8.15	10	11.4	35.09	800
P4SMAJ6.0A	P4SMAJ6.0CA	HG	TG	6.0	6.67	7.37	10	10.3	38.83	800
P4SMAJ6.5	P4SMAJ6.5C	HH	TH	6.5	7.22	8.82	10	12.3	32.52	500
P4SMAJ6.5A	P4SMAJ6.5CA	HK	TK	6.5	7.22	7.98	10	11.2	35.71	500
P4SMAJ7.0	P4SMAJ7.0C	HL	TL	7.0	7.78	9.51	10	13.3	30.08	200
P4SMAJ7.0A	P4SMAJ7.0CA	HM	TM	7.0	7.78	8.60	10	12.0	33.33	200
P4SMAJ7.5	P4SMAJ7.5C	HN	TN	7.5	8.33	10.20	1	14.3	27.97	100
P4SMAJ7.5A	P4SMAJ7.5CA	HP	TP	7.5	8.33	9.21	1	12.9	31.01	100
P4SMAJ8.0	P4SMAJ8.0C	HQ	TQ	8.0	8.89	10.90	1	15.0	26.67	50
P4SMAJ8.0A	P4SMAJ8.0CA	HR	TR	8.0	8.89	9.83	1	13.6	29.41	50
P4SMAJ8.5	P4SMAJ8.5C	HS	TS	8.5	9.44	11.50	1	15.9	25.16	10
P4SMAJ8.5A	P4SMAJ8.5CA	HT	TT	8.5	9.44	10.40	1	14.4	27.78	10
P4SMAJ9.0	P4SMAJ9.0C	HU	TU	9.0	10.00	12.20	1	16.9	23.67	5
P4SMAJ9.0A	P4SMAJ9.0CA	HV	TV	9.0	10.00	11.10	1	15.4	25.97	5
P4SMAJ10	P4SMAJ10C	HW	TW	10.0	11.10	13.60	1	18.8	21.28	1
P4SMAJ10A	P4SMAJ10CA	HX	TX	10.0	11.10	12.30	1	17.0	23.53	1
P4SMAJ11	P4SMAJ11C	HY	TY	11.0	12.20	14.90	1	20.1	19.90	1
P4SMAJ11A	P4SMAJ11CA	HZ	TZ	11.0	12.20	13.50	1	18.2	21.98	1
P4SMAJ12	P4SMAJ12C	ID	UD	12.0	13.30	16.30	1	22.0	18.18	1
P4SMAJ12A	P4SMAJ12CA	IE	UE	12.0	13.30	14.70	1	19.9	20.10	1
P4SMAJ13	P4SMAJ13C	IF	UF	13.0	14.40	17.60	1	23.8	16.81	1
P4SMAJ13A	P4SMAJ13CA	IG	UG	13.0	14.40	15.90	1	21.5	18.60	1
P4SMAJ14	P4SMAJ14C	IH	UH	14.0	15.60	19.10	1	25.8	15.50	1
P4SMAJ14A	P4SMAJ14CA	IK	UK	14.0	15.60	17.20	1	23.2	17.24	1
P4SMAJ15	P4SMAJ15C	IL	UL	15.0	16.70	20.40	1	26.9	14.87	1
P4SMAJ15A	P4SMAJ15CA	IM	UM	15.0	16.70	18.50	1	24.4	16.39	1
P4SMAJ16	P4SMAJ16C	IN	UN	16.0	17.80	21.80	1	28.8	13.89	1
P4SMAJ16A	P4SMAJ16CA	IP	UP	16.0	17.80	19.70	1	26.0	15.38	1
P4SMAJ17	P4SMAJ17C	IQ	UQ	17.0	18.90	23.10	1	30.5	13.11	1
P4SMAJ17A	P4SMAJ17CA	IR	UR	17.0	18.90	20.90	1	27.6	14.49	1
P4SMAJ18	P4SMAJ18C	IS	US	18.0	20.00	24.40	1	32.2	12.42	1
P4SMAJ18A	P4SMAJ18CA	IT	UT	18.0	20.00	22.10	1	29.2	13.70	1
P4SMAJ20	P4SMAJ20C	IU	UU	20.0	22.20	27.10	1	35.8	11.17	1
P4SMAJ20A	P4SMAJ20CA	IV	UV	20.0	22.20	24.50	1	32.4	12.35	1
P4SMAJ22	P4SMAJ22C	IW	UW	22.0	24.40	29.80	1	39.4	10.15	1
P4SMAJ22A	P4SMAJ22CA	IX	UX	22.0	24.40	26.90	1	35.5	11.27	1
P4SMAJ24	P4SMAJ24C	IY	UY	24.0	26.70	32.60	1	43.0	9.30	1
P4SMAJ24A	P4SMAJ24CA	IZ	UZ	24.0	26.70	29.50	1	38.9	10.28	1
P4SMAJ26	P4SMAJ26C	JD	VD	26.0	28.90	35.30	1	46.6	8.58	1
P4SMAJ26A	P4SMAJ26CA	JE	VE	26.0	28.90	31.90	1	42.1	9.50	1
P4SMAJ28	P4SMAJ28C	JF	VF	28.0	31.10	38.00	1	50.0	8.00	1
P4SMAJ28A	P4SMAJ28CA	JG	VG	28.0	31.10	34.40	1	45.4	8.81	1
P4SMAJ30	P4SMAJ30C	JH	VH	30.0	33.30	40.70	1	53.5	7.48	1
P4SMAJ30A	P4SMAJ30CA	JK	VK	30.0	33.30	36.80	1	48.4	8.26	1
P4SMAJ33	P4SMAJ33C	JL	VL	33.0	36.70	44.90	1	59.0	6.78	1
P4SMAJ33A	P4SMAJ33CA	JM	VM	33.0	36.70	40.60	1	53.3	7.50	1
P4SMAJ36	P4SMAJ36C	JN	VN	36.0	40.00	48.90	1	64.3	6.22	1
P4SMAJ36A	P4SMAJ36CA	JP	VP	36.0	40.00	44.20	1	58.1	6.88	1
P4SMAJ40	P4SMAJ40C	JQ	VQ	40.0	44.40	54.30	1	71.4	5.60	1
P4SMAJ40A	P4SMAJ40CA	JR	VR	40.0	44.40	49.10	1	64.5	6.20	1
P4SMAJ43	P4SMAJ43C	JS	VS	43.0	47.80	58.40	1	76.7	5.22	1
P4SMAJ43A	P4SMAJ43CA	JT	VT	43.0	47.80	52.80	1	69.4	5.76	1
P4SMAJ45	P4SMAJ45C	JU	VU	45.0	50.00	61.10	1	80.3	4.98	1
P4SMAJ45A	P4SMAJ45CA	JV	VV	45.0	50.00	55.30	1	72.7	5.50	1
P4SMAJ48	P4SMAJ48C	JW	VW	48.0	53.30	65.10	1	85.5	4.68	1
P4SMAJ48A	P4SMAJ48CA	JX	VX	48.0	53.30	58.90	1	77.4	5.17	1
P4SMAJ51	P4SMAJ51C	JY	VY	51.0	56.70	69.30	1	91.1	4.39	1
P4SMAJ51A	P4SMAJ51CA	JZ	VZ	51.0	56.70	62.70	1	82.4	4.85	1
P4SMAJ54	P4SMAJ54C	RD	WD	54.0	60.00	73.30	1	96.3	4.15	1
P4SMAJ54A	P4SMAJ54CA	RE	WE	54.0	60.00	66.30	1	87.1	4.59	1
P4SMAJ58	P4SMAJ58C	RF	WF	58.0	64.40	78.70	1	103.0	3.88	1
P4SMAJ58A	P4SMAJ58CA	RG	WG	58.0	64.40	71.20	1	93.6	4.27	1

*For bi-directional devices V_{RWM} ≤ 10V, the I_R limit is double.

Electrical Characteristics (@T_A=25°C unless otherwise specified) Table 1 (Cont'd)

Uni-Directional Part No.	Bi-Directional Part No.	Device Marking Code		Reverse Stand-Off Voltage V _{RWM} (V)	Breakdown Voltage V _{BR} (V) @I _T		Test Current I _T (mA)	Maximum Clamping Voltage @I _{PP} V _C (V)	Peak Pulse Current I _{PP} (A)	Reverse Leakage @V _{RWM} I _R (μA)
		UNI	BI		Min.	Max.				
P4SMAJ60	P4SMAJ60C	RH	WH	60.0	66.70	81.50	1	107.0	3.74	1
P4SMAJ60A	P4SMAJ60CA	RK	WK	60.0	66.70	73.70	1	96.8	4.13	1
P4SMAJ64	P4SMAJ64C	RL	WL	64.0	71.10	86.90	1	114.0	3.51	1
P4SMAJ64A	P4SMAJ64CA	RM	WM	64.0	71.10	78.60	1	103.0	3.88	1
P4SMAJ70	P4SMAJ70C	RN	WN	70.0	77.80	95.10	1	125.0	3.20	1
P4SMAJ70A	P4SMAJ70CA	RP	WP	70.0	77.80	86.00	1	113.0	3.54	1
P4SMAJ75	P4SMAJ75C	RQ	WQ	75.0	83.30	102.00	1	134.0	2.99	1
P4SMAJ75A	P4SMAJ75CA	RR	WR	75.0	83.30	92.10	1	121.0	3.31	1
P4SMAJ78	P4SMAJ78C	RS	WS	78.0	86.70	106.00	1	139.0	2.88	1
P4SMAJ78A	P4SMAJ78CA	RT	WT	78.0	86.70	95.80	1	126.0	3.17	1
P4SMAJ85	P4SMAJ85C	RU	WU	85.0	94.40	115.00	1	151.0	2.65	1
P4SMAJ85A	P4SMAJ85CA	RV	WV	85.0	94.40	104.00	1	137.0	2.92	1
P4SMAJ90	P4SMAJ90C	RW	WW	90.0	100.00	122.00	1	160.0	2.50	1
P4SMAJ90A	P4SMAJ90CA	RX	WX	90.0	100.00	111.00	1	146.0	2.74	1
P4SMAJ100	P4SMAJ100C	RY	WY	100.0	111.00	136.00	1	179.0	2.23	1
P4SMAJ100A	P4SMAJ100CA	RZ	WZ	100.0	111.00	123.00	1	162.0	2.47	1
P4SMAJ110	P4SMAJ110C	SD	XD	110.0	122.00	149.00	1	196.0	2.04	1
P4SMAJ110A	P4SMAJ110CA	SE	XE	110.0	122.00	135.00	1	177.0	2.26	1
P4SMAJ120	P4SMAJ120C	SF	XF	120.0	133.00	163.00	1	214.0	1.87	1
P4SMAJ120A	P4SMAJ120CA	SG	XG	120.0	133.00	147.00	1	193.0	2.07	1
P4SMAJ130	P4SMAJ130C	SH	XH	130.0	144.00	176.00	1	231.0	1.73	1
P4SMAJ130A	P4SMAJ130CA	SK	XK	130.0	144.00	159.00	1	209.0	1.91	1
P4SMAJ150	P4SMAJ150C	SL	XL	150.0	167.00	204.00	1	268.0	1.49	1
P4SMAJ150A	P4SMAJ150CA	SM	XM	150.0	167.00	185.00	1	243.0	1.65	1
P4SMAJ160	P4SMAJ160C	SN	XN	160.0	178.00	218.00	1	287.0	1.39	1
P4SMAJ160A	P4SMAJ160CA	SP	XP	160.0	178.00	197.00	1	259.0	1.54	1
P4SMAJ170	P4SMAJ170C	SQ	XQ	170.0	189.00	231.00	1	304.0	1.32	1
P4SMAJ170A	P4SMAJ170CA	SR	XR	170.0	189.00	209.00	1	275.0	1.45	1
P4SMAJ180	P4SMAJ180C	SS	YS	180.0	200.00	244.80	1	322.2	1.24	1
P4SMAJ180A	P4SMAJ180CA	ST	YT	180.0	200.00	220.00	1	291.6	1.37	1
P4SMAJ190	P4SMAJ190C	SU	YU	190.0	211.00	258.40	1	340.1	1.18	1
P4SMAJ190A	P4SMAJ190CA	SV	YV	190.0	211.00	232.00	1	307.8	1.30	1
P4SMAJ200A	P4SMAJ200CA	SX	YX	200.0	224.00	247.00	1	324.0	1.23	1
P4SMAJ220A	P4SMAJ220CA	GE	ZE	220.0	246.00	272.00	1	356.0	1.12	1
P4SMAJ250A	P4SMAJ250CA	GF	ZF	250.0	279.00	309.00	1	405.0	0.99	1
P4SMAJ300A	P4SMAJ300CA	GG	ZG	300.0	335.00	371.00	1	486.0	0.82	1
P4SMAJ350A	P4SMAJ350CA	GH	ZH	350.0	391.00	432.00	1	567.0	0.71	1
P4SMAJ400A	P4SMAJ400CA	GK	ZK	400.0	447.00	494.00	1	648.0	0.62	1
P4SMAJ440A	P4SMAJ440CA	GL	ZL	440.0	492.00	543.00	1	713.0	0.56	1

MARKING INFORMATION

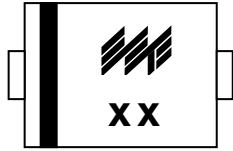

Cathode = Polarity Band Except Bi-Directional Types
 xx = Device Code, See Table 1

RECOMMENDED FOOTPRINT

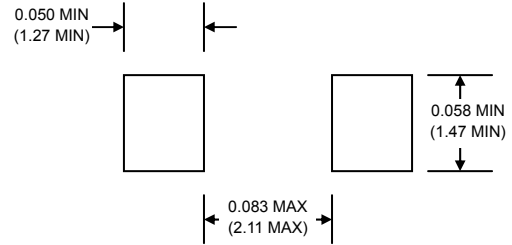

inches(mm)

PACKAGING INFORMATION

TAPE & REEL

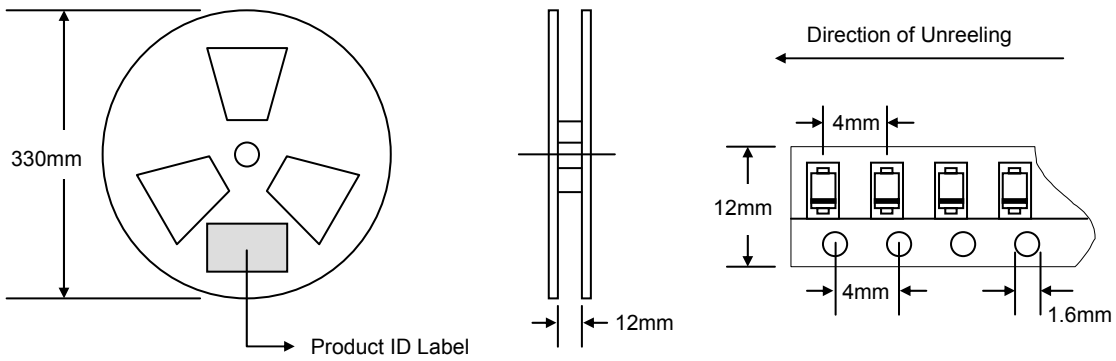

Reel Diameter (mm)	Quantity (PCS)	Inner Box Size L x W x H (mm)	Quantity (PCS)	Carton Size L x W x H (mm)	Quantity (PCS)	Approx. Gross Weight (KG)
330	5,000	340 x 337 x 45	10,000	370 x 370 x 420	80,000	14.0

Note: 1. Paper reel, white or gray color.
 2. Components are packed in accordance with EIA standard 481-1 and 481-2.

ORDERING INFORMATION

Product No.	Package Type	Shipping Quantity
P4SMAJxx-T3	SMA	5000/Tape & Reel

1. Shipping quantity given is for minimum packing quantity only. For minimum order quantity, please consult the Sales Department.
2. **To order RoHS / Lead Free version (with Lead Free finish), add "-LF" suffix to part number above. For example, P4SMAJ5.0-T3-LF.**

WON-TOP ELECTRONICS and  are registered trademarks of Won-Top Electronics Co., Ltd (WTE). WTE has checked all information carefully and believes it to be correct and accurate. However, WTE cannot assume any responsibility for inaccuracies. Furthermore, this information does not give the purchaser of semiconductor devices any license under patent rights to manufacturer. WTE reserves the right to change any or all information herein without further notice.

WARNING: DO NOT USE IN LIFE SUPPORT EQUIPMENT. WTE power semiconductor products are not authorized for use as critical components in life support devices or systems without the express written approval.

Won-Top Electronics Co., Ltd.
No. 44 Yu Kang North 3rd Road,
Chine Chen Dist., Kaohsiung 806, Taiwan
Phone: 886-7-822-5408 or 886-7-822-5410
Fax: 886-7-822-5417
Email: sales@wontop.com
Internet: <http://www.wontop.com>

We power your everyday.