



DESCRIPTION : 0.25W 3KVDC Isolated Single Output SMD DC/DC Converters

Miniature surface mounted DC/DC Converters are an ideal and economical solution for many applications where noise reduction, voltage isolation, voltage conversion in distributed power systems is required. these converters are qualified for the higher temperatures requested by lead-free reflow solder processes, especially for automated SMD production lines.

FEATURES

RoHS compliant, CE certification	Efficiency up to 78%	Single isolated output
3KVDC isolation	Custom solutions available	Power density 1.8W/cm ³
UL 94V-0 package material	Footprint over pins 1.37cm ²	Operating temperature: -40°C to 105°C
Input voltage: 3.3V, 5V,12V,15V,24V	Output voltage:3.3V, 5V, 9V, 12V,15V	/

SELECTION GUIDE

Part Number	Nominal Input Voltage	Output Voltage	Output Current (Max./Min)	Efficiency
	V	V	mA	%
TPET0303-W2	3.3	3.3	76/7.6	72
TPET0305-W2	3.3	5	50/5	77
TPET0309-W2	3.3	9	28/2.8	77
TPET0312-W2	3.3	12	20.8/2.08	77
TPET0315-W2	3.3	15	16.7/1.67	77
TPET0503-W2	5	3.3	76/7.6	74
TPET0505-W2	5	5	50/5	69
TPET0509-W2	5	9	28/2.8	75
TPET0512-W2	5	12	20.8/2.08	78
TPET0515-W2	5	15	16.7/1.67	78
TPET1203-W2	12	3.3	76/7.6	74
TPET1205-W2	12	5	50/5	67
TPET1209-W2	12	9	28/2.8	73
TPET1212-W2	12	12	20.8/2.08	74
TPET1215-W2	12	15	16.7/1.67	75
TPET1505-W2	15	5	50/5	77
TPET1515-W2	15	15	16.7/1.67	75
TPET2403-W2	24	3.3	76/7.6	74
TPET2405-W2	24	5	50/5	67
TPET2409-W2	24	9	28/2.8	73
TPET2412-W2	24	12	20.8/2.08	74
TPET2415-W2	24	15	16.7/1.67	75

Add suffix "P" for continuous short circuit protection, for example TPET0505P-W2. Add suffix "X" has not 5,10,12 pin, for example TPET0505X-W2.

INPUT CHARACTERISTICS

Parameter	Conditions	Min.	Typ.	Max.	Units
Voltage range	3.3V input variants	2.9	3.3	3.6	V
Voltage range	5V input variants	4.5	5.0	5.5	V
Voltage range	12V input variants	11	12.0	13.3	V
Voltage range	15V input variants	13.4	15	16.4	V
Voltage range	24V input variants	22	24	26.5	V

ISOLATION CHARACTERISTICS

Parameter	Conditions	Min.	Typ.	Max.	Units
Isolation voltage	Tested for 1 second		3000		VDC
Resistance	Viso= 1000VDC	1			GΩ

ABSOLUTE MAXIMUM RATINGS

Short-circuit protection	1 second
Lead temperature 1.5mm from case for 10 seconds	300°C
Internal power dissipation	610mW
Input voltage Vin, TPET03xx-W2	5.5V
Input voltage Vin, TPET05xx-W2	7V
Input voltage Vin, TPET12xx-W2	15V
Input voltage Vin, TPET15xx-W2	18V
Input voltage Vin, TPET24xx-W2	28V

All specifications typical at TA=25°C, nominal input voltage and rated output current unless otherwise specified.

OUTPUT CHARACTERISTICS

Parameter	Conditions	Min.	Typ.	Max.	Units
Rated power	TA=-40°C to 85°C			1.0	W
Voltage set point accuracy	See tolerance envelope				
Line regulation	High Vin to low Vin		1.0	1.2	%/%
Load regulation(10% load to rated load)	03XX,0503,1203 & 2403		10	14	%
Load regulation(10% load to rated load)	0505,1205 & 2405		13	15	%
Load regulation(10% load to rated load)	0509,1209 & 2409		8.0	9.0	%
Load regulation(10% load to rated load)	0512,1212 & 2412		6.5	7.5	%
Load regulation(10% load to rated load)	0515,1215, 1515 & 2415		6	7.0	%

GENERAL CHARACTERISTICS

Parameter	Conditions	Min.	Typ.	Max.	Units
Switching frequency	All output types		120		kHz

TEMPERATURE CHARACTERISTICS

Parameter	Conditions	Min.	Typ.	Max.	Units
Specification	Derating if the temperature ≥85°C	-40		105	°C
Storage		-55		125	°C
Cooling	Free air convection				

TEMPERATURE DERATING GRAPHS

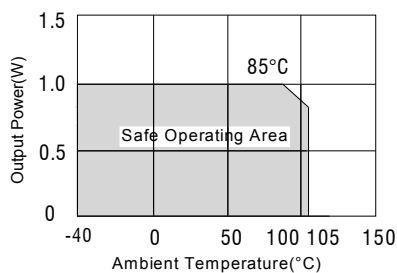

TOLERANCE ENVELOPES

3.3V output types

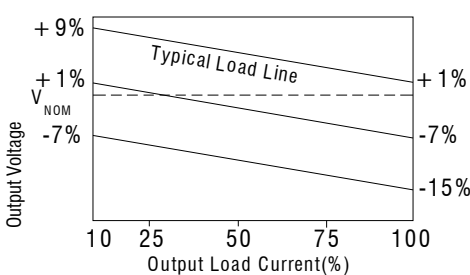

All other types

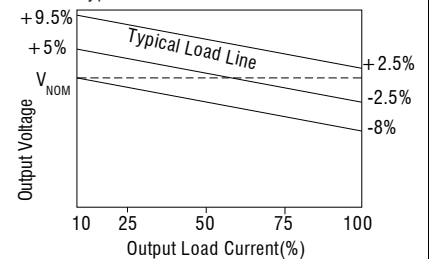

MECHANICAL DIMENSIONS

SMD Package

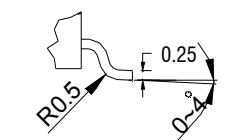
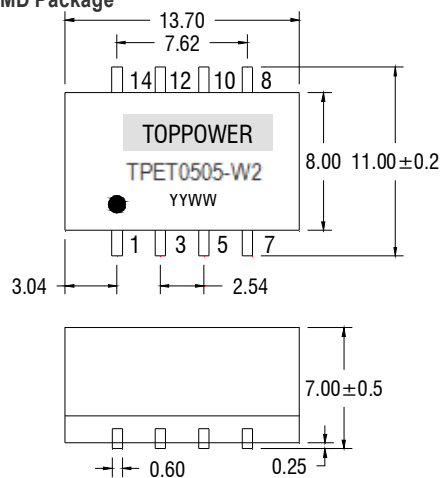

(Magnification of A)

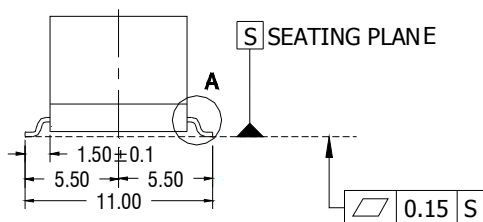

PIN CONNECTIONS

8 PIN SMD		
Pin	Function	Add suffix "X" function
1	-Vin	-Vin
3	+Vin	+Vin
5	NA	No Pin
7	-Vout	-Vout
8	+Vout	+Vout
10	NA	No Pin
12	NA	No Pin
14	NA	NA

NA - Not available for electrical connection.

All dimensions in mm ±0.25mm. All pins on a 2.54mm pitch and within ±0.25mm of true position.
Weight: 1.21g

RECOMMENDED FOOTPRINT DETAILS

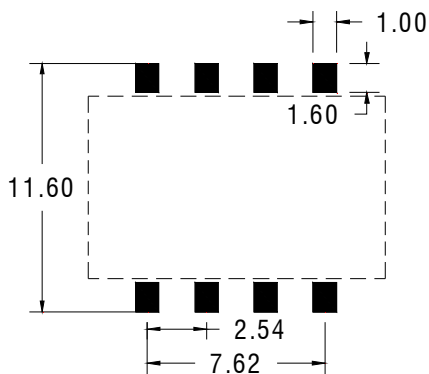

All pins on a 2.54mm pitch.
Unless otherwise stated all dimensions in mm ± 0.5mm.

TUBE OUTLINE DIMENSIONS

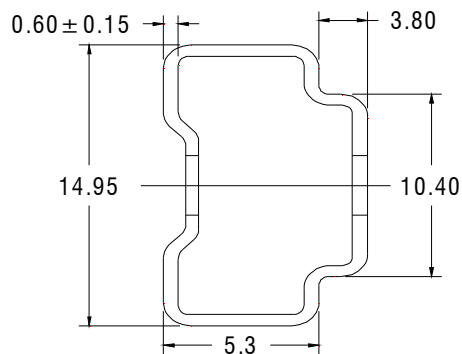

Unless otherwise stated all dimensions in mm ± 0.25mm.
Tube length: 475mm ± 2.0mm Tube Quantity: 35PCS

REEL OUTLINE DIMENSIONS

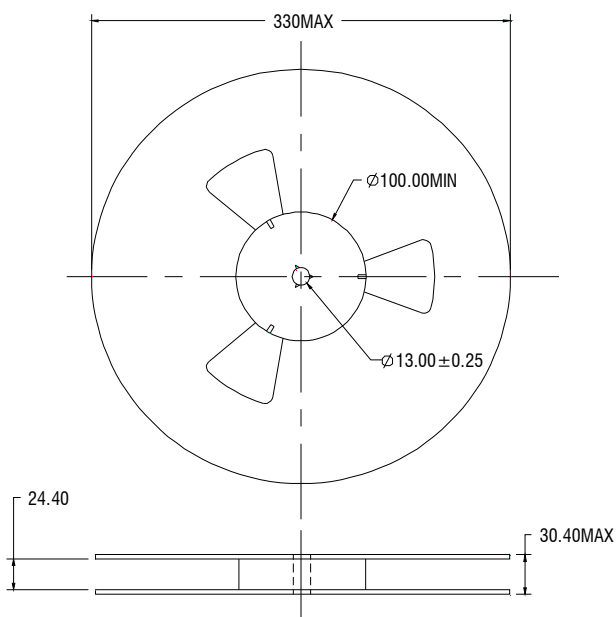

TAPE OUTLINE DIMENSIONS

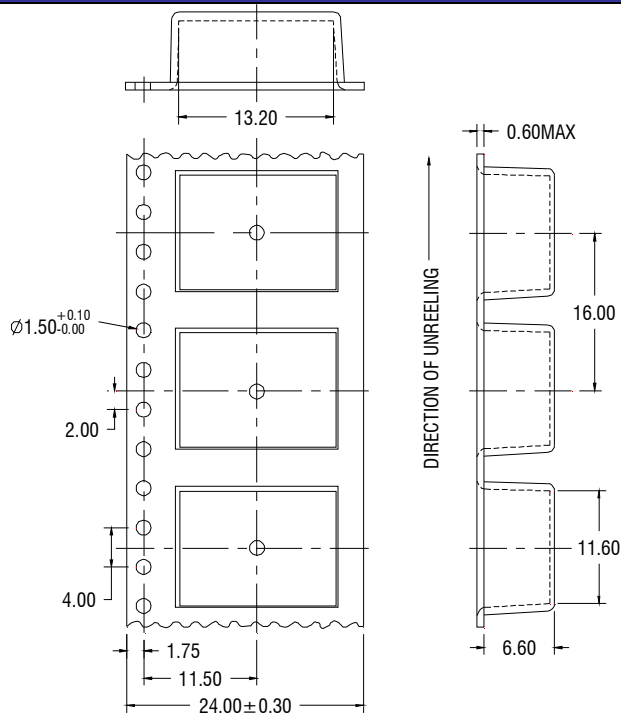

REEL PACKAGING DETAILS

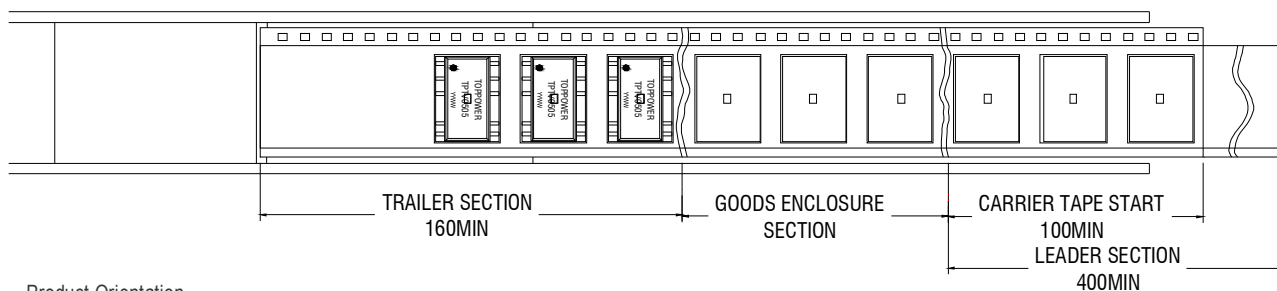

Product Orientation
Pin 1, located nearest to carrier drive sprocket Reel Quantity : 500PCS

● Less than 500pcs, will be tube packing !