

LOW VOLTAGE DETECTOR

NO.EA-115-130501

OUTLINE

The R3113D series are CMOS-based voltage detector ICs with high detector threshold accuracy and ultra-low supply current, which can be operated at an extremely low voltage and is used for system reset as an example.

Each of these ICs consists of a voltage reference unit, a comparator, resistors for detector threshold setting, an output driver and a hysteresis circuit. The detector threshold is fixed with high accuracy internally and does not require any adjustment.

Two output types, Nch open drain type and CMOS type are available.

Since the package is ultra-small SON1408-3 (MFPK), high density mounting on board is possible.

FEATURES

- Supply Current Typ. 1.4 μ A ($-V_{DET} > 1.5V$; $V_{DD} = -V_{DET} + 1.0V$)
- Operating Voltage Range 0.6V to 6.0V ($-V_{DET} = 3.0V$, $T_{opt} = 25^{\circ}C$)
- Detector Threshold 1.2V to 4.5V (0.1V step)
- Detector Threshold Accuracy $\pm 2.0\%$
- Temperature-Drift Coefficient of Detector Threshold Typ. $\pm 100ppm/^{\circ}C$
- Output Types Nch Open Drain and CMOS
- Package SON1408-3

APPLICATIONS

- CPU and Logic Circuit Reset
- Battery Checker
- Window Comparator
- Wave Shaping Circuit
- Battery Back-up Circuit
- Power Failure Detector

BLOCK DIAGRAMS

Nch Open Drain Output (R3113Dxx1A)

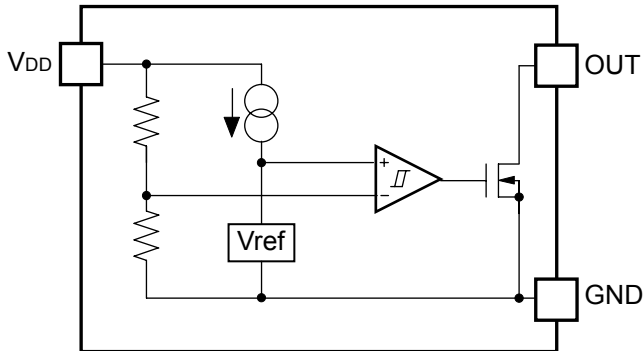

CMOS Output (R3113Dxx1C)

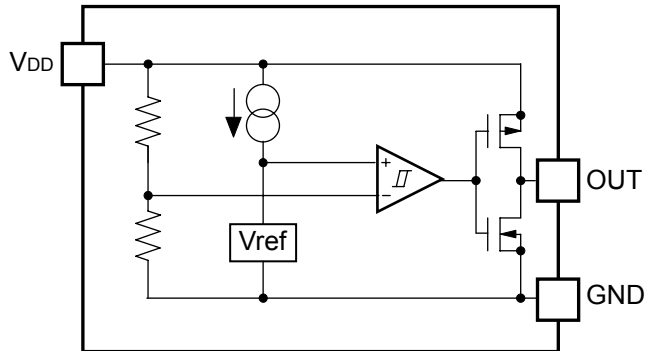

SELECTION GUIDE

The package type, the detector threshold, and the output type for the ICs can be selected at the users' request. The selection can be made with designating the part number as shown below;

Product Name	Package	Quantity per Reel	Pb Free	Halogen Free
R3113Dxx1*-TR-F	SON1408-3	9,000 pcs	Yes	Yes

xx: The detector threshold can be designated in the range from 1.2V(12) to 4.5V(45) in 0.1V steps.

* : Designation of Output Type
 (A) Nch Open Drain
 (C) CMOS

The products scheduled to be discontinued : "Non-promotion"

These products will be discontinued in the future. We advise you to select other products.

PIN CONFIGURATION

- SON1408-3

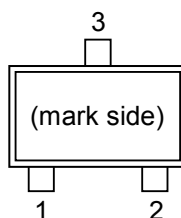

PIN DESCRIPTION

- SON1408-3

Pin No	Symbol	Pin Description
1	OUT	Output Pin ("L" at detection)
2	V _{DD}	Input Pin
3	GND	Ground Pin

ABSOLUTE MAXIMUM RATINGS

Symbol	Item	Rating	Unit
V_{DD}	Supply Voltage	6.5	V
V_{OUT1}	Output Voltage (Nch Open Drain Output)	$V_{SS}-0.3$ to 6.5	V
V_{OUT2}	Output Voltage (CMOS Output)	$V_{SS}-0.3$ to $V_{DD}+0.3$	
I_{OUT}	Output Current	20	mA
P_D	Power Dissipation (SON1408-3) ^{*1, *2}	250	mW
T_{opt}	Operating Temperature Range	-40 to 85	°C
T_{stg}	Storage Temperature Range	-55 to 125	°C
T_{solder}	Lead temperature (Soldering)	260°C, 10s	

*1) Applied to SON1408-3 at mounted on board

P_D depends on conditions of mounting on board.

This specification is based on the measurement at the condition below:

*Measurement Conditions

Environment: Mounted on board (Wind velocity 0m/s)

Board Material: FR-4 (2-layer)

Board dimensions: 40mm × 40mm × t1.6mm

Copper Area: 50%(Both Sides)

Tab pin (Pin 3) land pattern width is same as the lead, connected to the GND plane.

*2) For Power Dissipation, please refer to PACKAGE INFORMATION.

ABSOLUTE MAXIMUM RATINGS

Electronic and mechanical stress momentarily exceeded absolute maximum ratings may cause the permanent damages and may degrade the life time and safety for both device and system using the device in the field. The functional operation at or over these absolute maximum ratings is not assured.

ELECTRICAL CHARACTERISTICS

● R3113D121A/C

T_{opt}=25°C

Symbol	Item	Conditions	Min.	Typ.	Max.	Unit
-V _{DET}	Detector Threshold		1.176	1.200	1.224	V
V _{HYS}	Detector Threshold Hysteresis		0.036	0.060	0.084	V
I _{SS}	Supply Current	V _{DD} =(-V _{DET})-0.1V		0.8	2.0	μA
		V _{DD} =(-V _{DET})+1.0V		1.1	2.7	
V _{DDH}	Maximum Operating Voltage				6	V
V _{DDL}	Minimum Operating Voltage *Note1	T _{opt} =25°C		0.65	0.85	V
		-40°C≤T _{opt} ≤85°C			0.95	
I _{OUT}	Output Current (Driver Output Pin)	Nch	V _{DS} =0.05V V _{DD} =0.85V	0.2	0.3	mA
			V _{DS} =0.50V V _{DD} =1.10V	1.0	2.2	
		Pch	V _{DS} =-2.1V V _{DD} =4.5V	2.0	5.0	
t _{PLH}	Output Delay Time *Note2				100	μs
Δ-V _{DET} /ΔT _{opt}	Detector Threshold Temperature Coefficient	-40°C≤T _{opt} ≤85°C		±100		ppm/°C

● R3113D181A/C

T_{opt}=25°C

Symbol	Item	Conditions	Min.	Typ.	Max.	Unit
-V _{DET}	Detector Threshold		1.764	1.800	1.836	V
V _{HYS}	Detector Threshold Hysteresis		0.054	0.090	0.126	V
I _{SS}	Supply Current	V _{DD} =(-V _{DET})-0.1V		1.3	3.3	μA
		V _{DD} =(-V _{DET})+1.0V		1.4	3.6	
V _{DDH}	Maximum Operating Voltage				6	V
V _{DDL}	Minimum Operating Voltage *Note1	T _{opt} =25°C		0.45	0.70	V
		-40°C≤T _{opt} ≤85°C			0.80	
I _{OUT}	Output Current (Driver Output Pin)	Nch	V _{DS} =0.05V V _{DD} =0.70V	0.05	0.13	mA
			V _{DS} =0.50V V _{DD} =1.50V	2.0	5.0	
		Pch	V _{DS} =-2.1V V _{DD} =4.5V	2.0	5.0	
t _{PLH}	Output Delay Time *Note2				100	μs
Δ-V _{DET} /ΔT _{opt}	Detector Threshold Temperature Coefficient	-40°C≤T _{opt} ≤85°C		±100		ppm/°C

R3113D

Non-prpmotion

● R3113D271A/C

T_{opt}=25°C

Symbol	Item	Conditions	Min.	Typ.	Max.	Unit
-V _{DET}	Detector Threshold		2.646	2.700	2.754	V
V _{HYS}	Detector Threshold Hysteresis		0.081	0.135	0.189	V
I _{SS}	Supply Current	V _{DD} =(-V _{DET})-0.1V		1.3	3.3	μA
		V _{DD} =(-V _{DET})+1.0V		1.4	3.6	
V _{DDH}	Maximum Operating Voltage				6	V
V _{DDL}	Minimum Operating Voltage *Note1	T _{opt} =25°C		0.45	0.70	V
		-40°C≤T _{opt} ≤85°C			0.80	
I _{OUT}	Output Current (Driver Output Pin)	Nch	V _{DS} =0.05V V _{DD} =0.70V	0.05	0.13	mA
			V _{DS} =0.50V V _{DD} =1.50V	2.0	5.0	
		Pch	V _{DS} =-2.1V V _{DD} =4.5V	2.0	5.0	
t _{PLH}	Output Delay Time *Note2				100	μs
Δ-V _{DET} /ΔT _{opt}	Detector Threshold Temperature Coefficient	-40°C≤T _{opt} ≤85°C		±100		ppm/°C

● R3113D361A/C

T_{opt}=25°C

Symbol	Item	Conditions	Min.	Typ.	Max.	Unit
-V _{DET}	Detector Threshold		3.528	3.600	3.672	V
V _{HYS}	Detector Threshold Hysteresis		0.108	0.180	0.252	V
I _{SS}	Supply Current	V _{DD} =(-V _{DET})-0.1V		1.3	3.3	μA
		V _{DD} =(-V _{DET})+1.0V		1.4	3.6	
V _{DDH}	Maximum Operating Voltage				6	V
V _{DDL}	Minimum Operating Voltage *Note1	T _{opt} =25°C		0.45	0.70	V
		-40°C≤T _{opt} ≤85°C			0.80	
I _{OUT}	Output Current (Driver Output Pin)	Nch	V _{DS} =0.05V V _{DD} =0.70V	0.05	0.13	mA
			V _{DS} =0.50V V _{DD} =1.50V	2.0	5.0	
		Pch	V _{DS} =-2.1V V _{DD} =4.5V	2.0	5.0	
t _{PLH}	Output Delay Time *Note2				100	μs
Δ-V _{DET} /ΔT _{opt}	Detector Threshold Temperature Coefficient	-40°C≤T _{opt} ≤85°C		±100		ppm/°C

● R3113D451A/C

T_{opt}=25°C

Symbol	Item	Conditions	Min.	Typ.	Max.	Unit
-V _{DET}	Detector Threshold		4.410	4.500	4.590	V
V _{HYS}	Detector Threshold Hysteresis		0.135	0.225	0.315	V
I _{SS}	Supply Current	V _{DD} =(-V _{DET})-0.1V		1.3	3.3	μA
		V _{DD} =(-V _{DET})+1.0V		1.4	3.6	
V _{DDH}	Maximum Operating Voltage				6	V
V _{DDL}	Minimum Operating Voltage *Note1	T _{opt} =25°C		0.45	0.70	V
		-40°C≤T _{opt} ≤85°C			0.80	
I _{OUT}	Output Current (Driver Output Pin)	Nch	V _{DS} =0.05V V _{DD} =0.70V	0.05	0.13	mA
			V _{DS} =0.50V V _{DD} =1.50V	2.0	5.0	
		Pch	V _{DS} =-2.1V V _{DD} =6.0V	2.5	6.0	
t _{PLH}	Output Delay Time *Note2				100	μs
Δ-V _{DET} /ΔT _{opt}	Detector Threshold Temperature Coefficient	-40°C≤T _{opt} ≤85°C		±100		ppm/°C

*Note1: The Minimum operating voltage means the value of input voltage when output voltage maintains 0.1V or less. (In the case of Nch Open Drain Output type, the output pin is pulled up with a resistance of 470kΩ to 5.0V.)

*Note2: In the case of CMOS Output type: The time interval between the rising edge of V_{DD} input pulse from 0.85V to (+V_{DET}) +1.0V and output voltage level becoming to V_{DD}/2.
In the case of Nch Open Drain Output: The time interval between the rising edge of V_{DD} input pulse from 0.85V to (+V_{DET}) +1.0V and output voltage level becoming to 2.5V.

RECOMMENDED OPERATING CONDITIONS (ELECTRICAL CHARACTERISTICS)

All of electronic equipment should be designed that the mounted semiconductor devices operate within the recommended operating conditions. The semiconductor devices cannot operate normally over the recommended operating conditions, even if when they are used over such conditions by momentary electronic noise or surge. And the semiconductor devices may receive serious damage when they continue to operate over the recommended operating conditions.

R3113D

Non-prpmotion

ELECTRICAL CHARACTERISTICS BY DETECTOR THRESHOLD

• R3113D121x to R3113D451x

Part Number	Detector Threshold			Detector Threshold Hysteresis			Supply Current 1			Supply Current 2			Output Current 1		
	-V _{DET} [V]			V _{HYS} [V]			I _{SS1} [μA]			I _{SS2} [μA]			I _{OUT1} [mA]		
	Min.	Typ.	Max.	Min.	Typ.	Max.	Condition	Typ.	Max.	Condition	Typ.	Max.	Condition	Min.	Typ.
R3113D121x	1.176	1.200	1.224	0.036	0.060	0.084	V _{DD} = (-V _{DET}) -0.10V	0.8	2.0	V _{DD} = (-V _{DET}) +1.0V	1.1	2.7	Nch V _{DS} =0.05V V _{DD} =0.85V	0.2	0.3
R3113D131x	1.274	1.300	1.326	0.039	0.065	0.091									
R3113D141x	1.372	1.400	1.428	0.042	0.070	0.098									
R3113D151x	1.470	1.500	1.530	0.045	0.075	0.105									
R3113D161x	1.568	1.600	1.632	0.048	0.080	0.112									
R3113D171x	1.666	1.700	1.734	0.051	0.085	0.119									
R3113D181x	1.764	1.800	1.836	0.054	0.090	0.126									
R3113D191x	1.862	1.900	1.938	0.057	0.095	0.133									
R3113D201x	1.960	2.000	2.040	0.060	0.100	0.140									
R3113D211x	2.058	2.100	2.142	0.063	0.105	0.147									
R3113D221x	2.156	2.200	2.244	0.066	0.110	0.154									
R3113D231x	2.254	2.300	2.346	0.069	0.115	0.161									
R3113D241x	2.352	2.400	2.448	0.072	0.120	0.168									
R3113D251x	2.450	2.500	2.550	0.075	0.125	0.175									
R3113D261x	2.548	2.600	2.652	0.078	0.130	0.182									
R3113D271x	2.646	2.700	2.754	0.081	0.135	0.189									
R3113D281x	2.744	2.800	2.856	0.084	0.140	0.196									
R3113D291x	2.842	2.900	2.958	0.087	0.145	0.203									
R3113D301x	2.940	3.000	3.060	0.090	0.150	0.210									
R3113D311x	3.038	3.100	3.162	0.093	0.155	0.217									
R3113D321x	3.136	3.200	3.264	0.096	0.160	0.224									
R3113D331x	3.234	3.300	3.366	0.099	0.165	0.231									
R3113D341x	3.332	3.400	3.468	0.102	0.170	0.238									
R3113D351x	3.430	3.500	3.570	0.105	0.175	0.245									
R3113D361x	3.528	3.600	3.672	0.108	0.180	0.252									
R3113D371x	3.626	3.700	3.774	0.111	0.185	0.259									
R3113D381x	3.724	3.800	3.876	0.114	0.190	0.266									
R3113D391x	3.822	3.900	3.978	0.117	0.195	0.273									
R3113D401x	3.920	4.000	4.080	0.120	0.200	0.280									
R3113D411x	4.018	4.100	4.182	0.123	0.205	0.287									
R3113D421x	4.116	4.200	4.284	0.126	0.210	0.294									
R3113D431x	4.214	4.300	4.386	0.129	0.215	0.301									
R3113D441x	4.312	4.400	4.488	0.132	0.220	0.308									
R3113D451x	4.410	4.500	4.590	0.135	0.225	0.315									

*1) In the case of CMOS Output type:

The time interval between the rising edge of V_{DD} input pulse from 0.85V to (+V_{DET}) +1.0V and output voltage level becoming to V_{DD}/2.

In the case of Nch Open Drain Output type:

The time interval between the rising edge of V_{DD} input pulse from 0.85V to (+V_{DET}) +1.0V and output voltage level becoming to 2.5V.

*2) The Minimum operating voltage means the value of input voltage when output voltage maintains 0.1V or less. (In the case of Nch Open Drain Output type, the output pin is pulled up with a resistance of 470kΩ to 5.0V.)

Topt=25°C

Output Current 2			Output Current 3			Output Delay Time	Minimum Operating Voltage		Detector Threshold Temperature Coefficient	
I _{OUT2} [mA]			I _{OUT3} [mA]			t _{PLH} [μs]	V _{DDL} [V]		Δ-V _{DET} /ΔT _{opt} [ppm/°C]	
Condition	Min.	Typ.	Condition	Min.	Typ.	Max.	Typ.	Max.	Condition	Typ.
Nch V _{DS} =0.5V V _{DD} =1.1V	1.0	2.2	Pch V _{DS} =-2.1V V _{DD} =4.5V	2.0	5.0	*1 100	*2 Topt=25°C: 0.65 40°C≤Topt≤85°C: -	*2 Topt=25°C: 0.85 40°C≤Topt≤85°C: 0.95	40°C≤Topt≤85°C	±100
Nch V _{DS} =0.5V V _{DD} =1.5V	2.0	5.0					*2 Topt=25°C: 0.45 40°C≤Topt≤85°C: -	*2 Topt=25°C: 0.70 40°C≤Topt≤85°C: 0.80		
			Pch V _{DS} =-2.1V V _{DD} =6.0V	2.5	6.0					

TIMING CHART

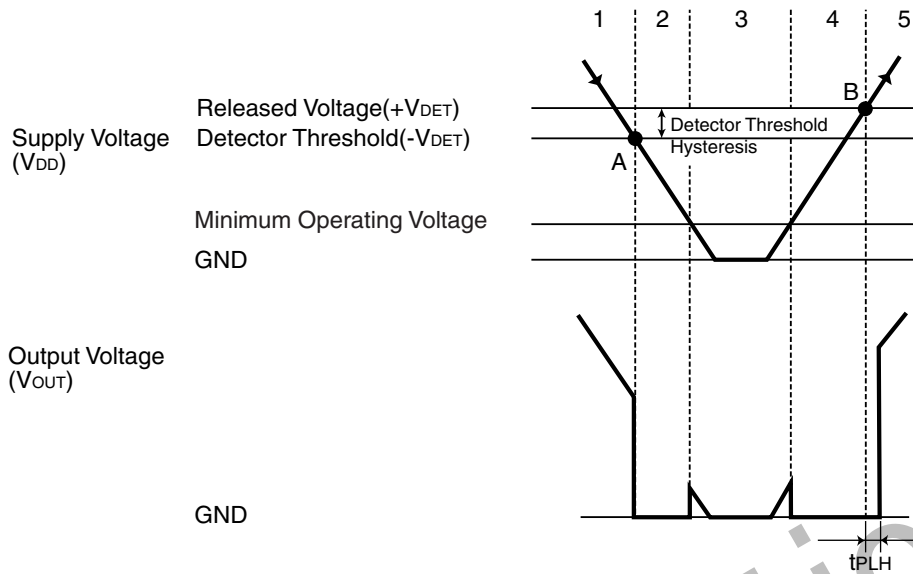

DEFINITION OF OUTPUT DELAY TIME

Output Delay Time (t_{PLH}) is defined as follows:

1. In the case of Nch Open Drain Output:
Under the condition of the output pin (OUT) is pulled up through a resistor of 470k Ω to 5V, the time interval between the rising edge of V_{DD} pulse from 0.85V to $(+V_{DET})+1.0V$ and becoming of the output voltage to 2.5V.
2. In the case of CMOS Output:
The time interval between the rising edge of V_{DD} pulse from 0.85V to $(+V_{DET})+1.0V$ and becoming of the output voltage to $(V_{DD}/2)V$.

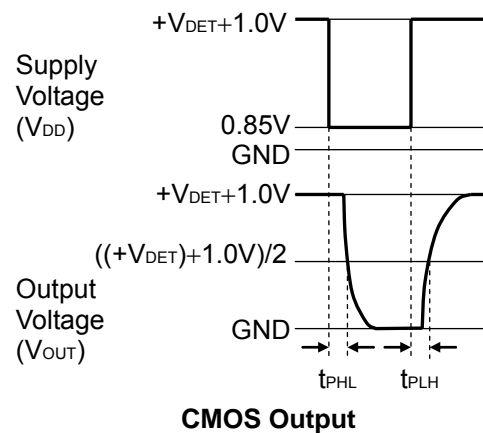
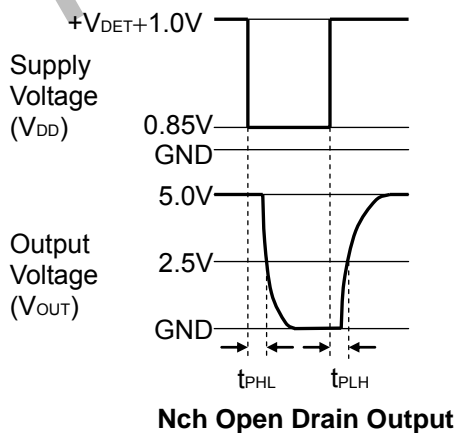

OPERATION

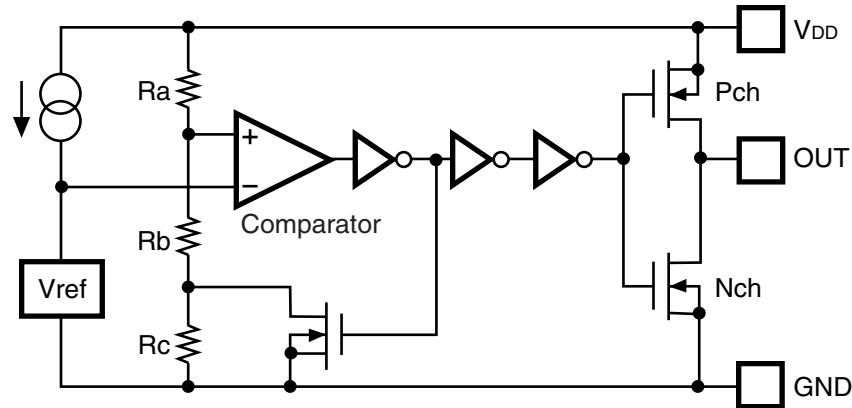

Figure 1. Block Diagram

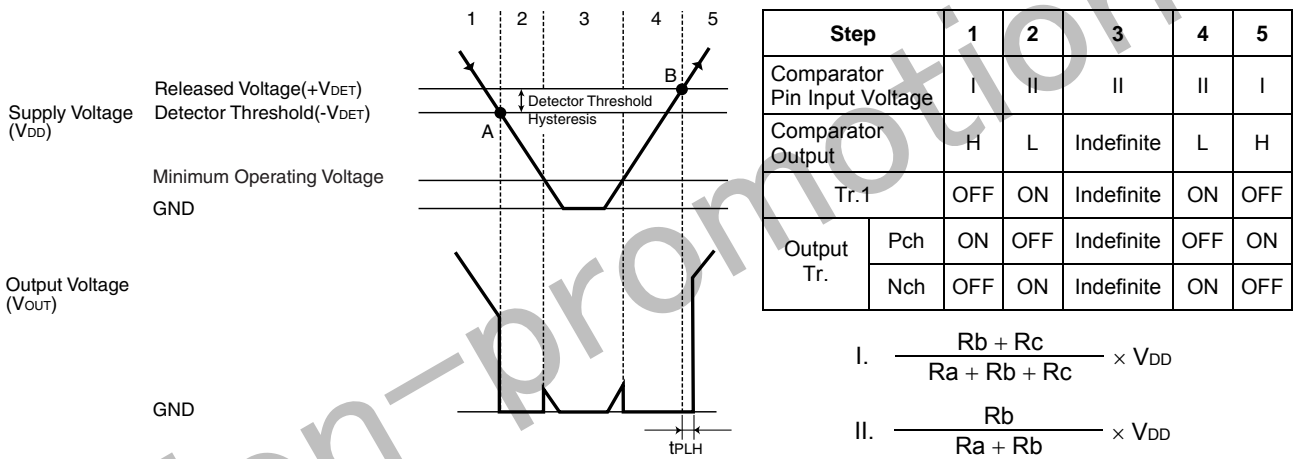

Figure 2. Operation Diagram

- Step 1. The output voltage is equal to the supply voltage (V_{DD}).
 - Step 2. At Point "A", $V_{ref} \geq V_{DD} \times (R_b + R_c) / (R_a + R_b + R_c)$ is true, as a result, the output of comparator is reverse, and output voltage becomes to GND level. The voltage level of Point A means detector threshold voltage, or ($-V_{DET}$).
 - Step 3. When the supply voltage is less than minimum operating voltage, the operation of output transistor becomes indefinite, and in the case that output is pulled up to V_{DD} , the output voltage equals to V_{DD} voltage.
 - Step 4. The output voltage equals to GND level.
 - Step 5. At Point "B", $V_{ref} \leq V_{DD} \times R_b / (R_a + R_b)$ is true, Output of the comparator is reverse, and output voltage is equal to the supply voltage, or (V_{DD}). The voltage level of Point B means released voltage, or ($+V_{DET}$).
- * The difference between released voltage and detector threshold voltage is the detector threshold hysteresis.

TEST CIRCUITS

*Pull-up circuit is not necessary for CMOS Output type, or R3113DxxxC.

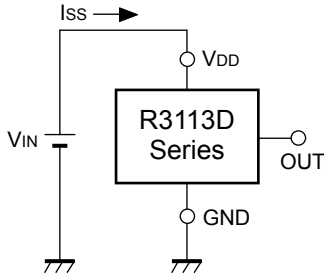

Figure 3. Supply Current Test Circuit

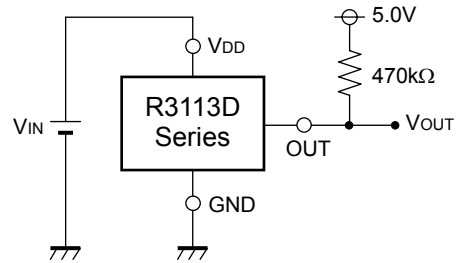

Figure 4. Detector Threshold Test Circuit

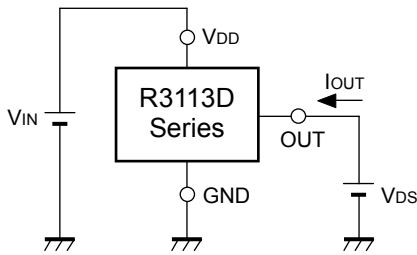

Figure 5. Nch Driver Output Current Test Circuit

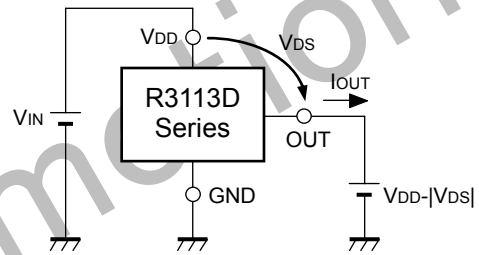

Figure 6. Pch Driver Output Current Test Circuit

*Apply only to CMOS

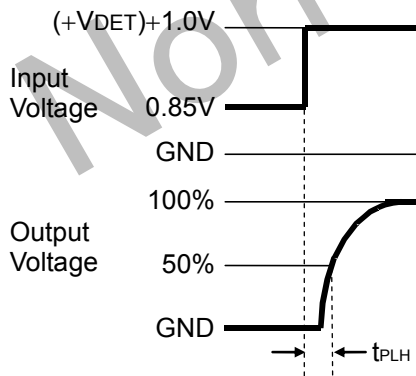

Figure 7. Output Delay Time Test Circuit (1)

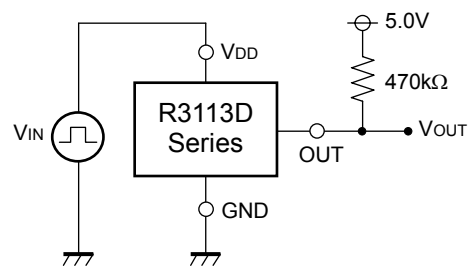
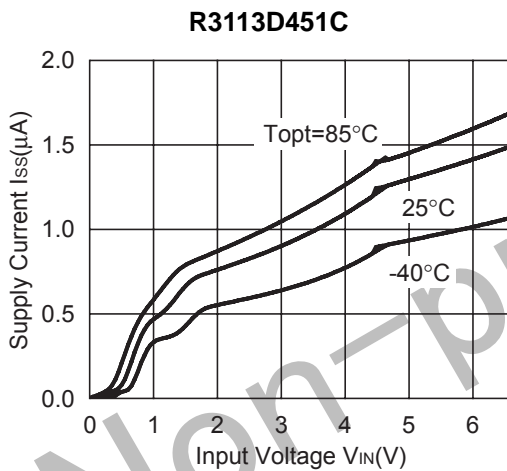
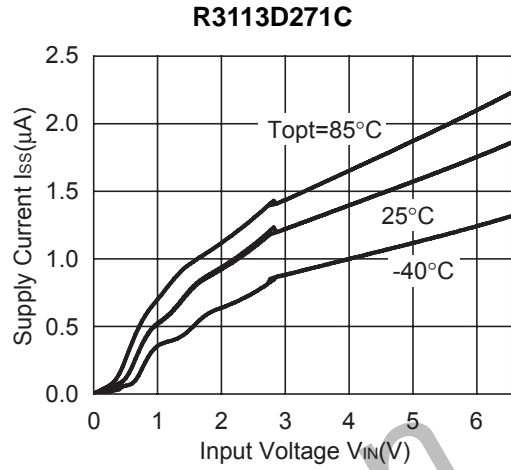
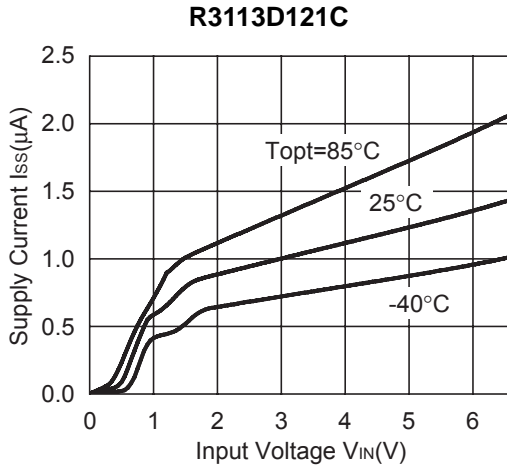

Figure 8. Output Delay Time Test Circuit (2)

TYPICAL CHARACTERISTICS

1) Supply Current vs. Input Voltage



2) Detector Threshold Hysteresis vs. Temperature

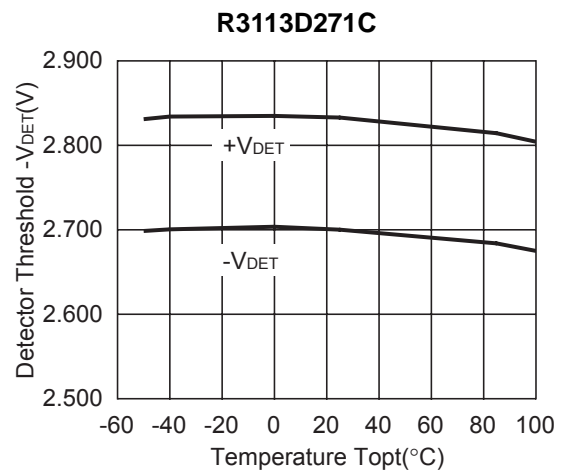
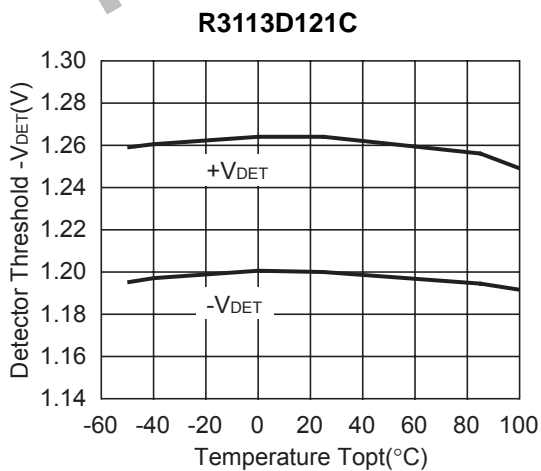

R3113D

Non-prpmotion

R3113D451C

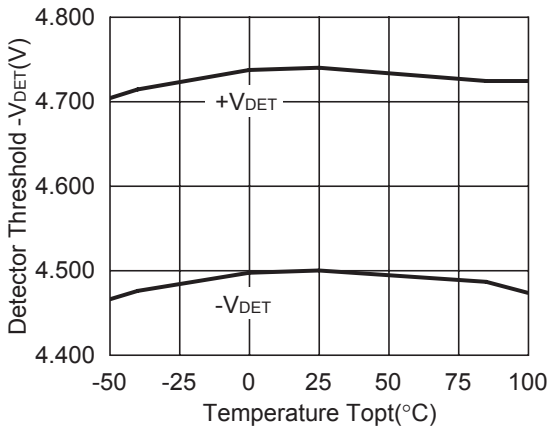

3) Output Voltage vs. Input Voltage

R3113D121C

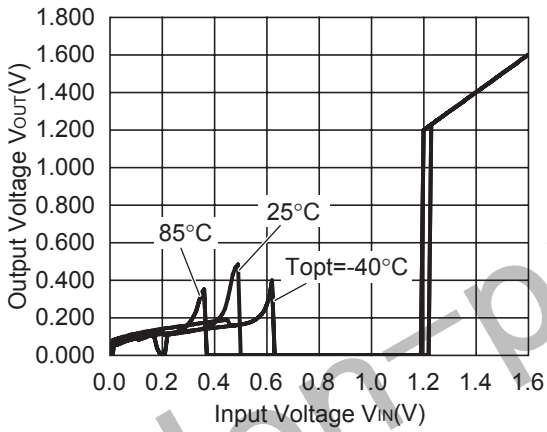

R3113D121A

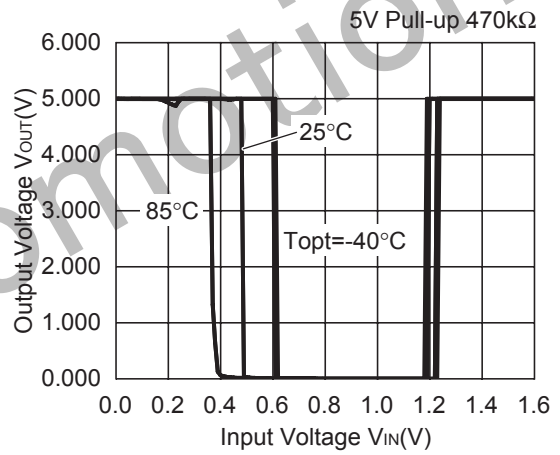

R3113D271C

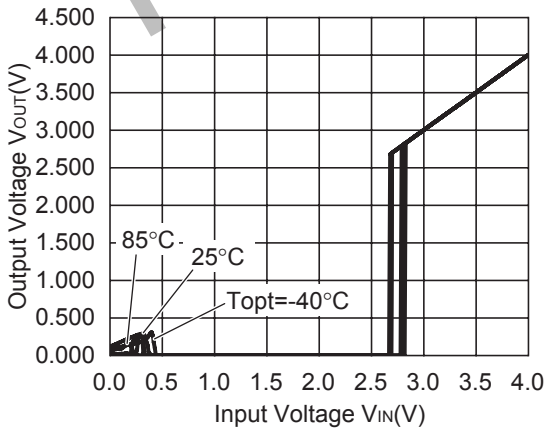

R3113D271A

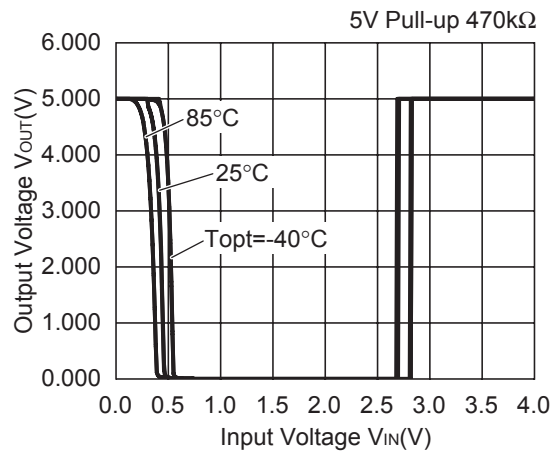

R3113D451C

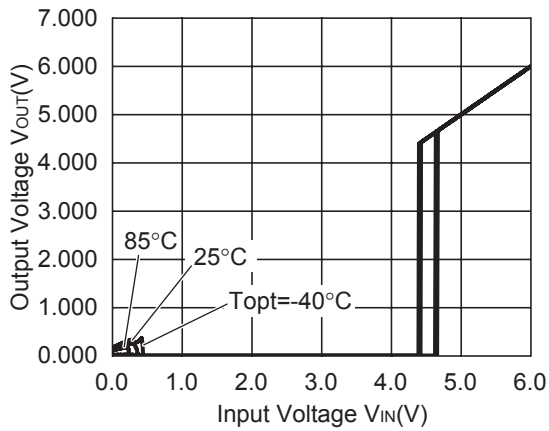

R3113D451A

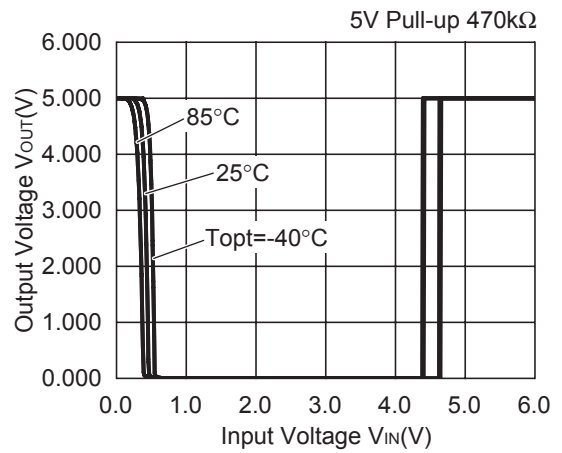

4) Nch Driver Output Current vs. V_{DS}

R3113D121C

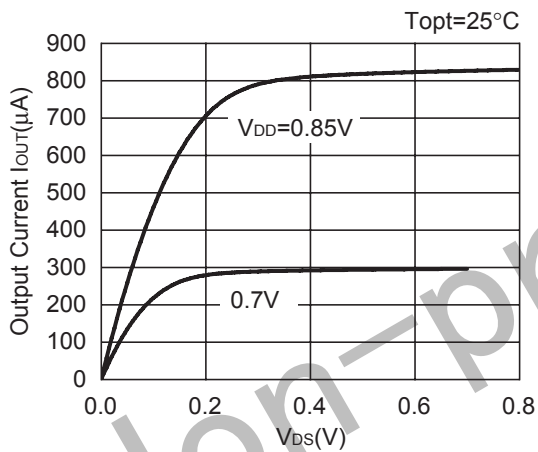

R3113D121C

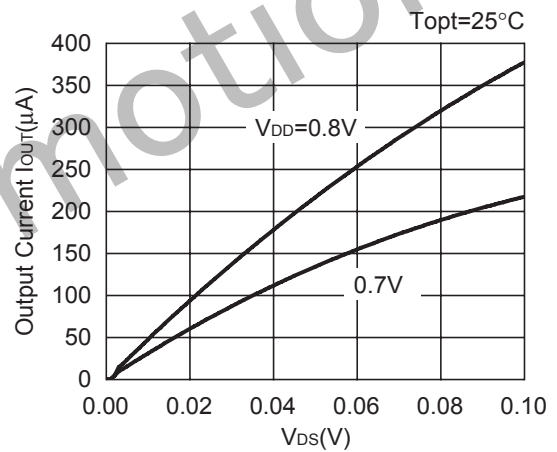

R3113D271C

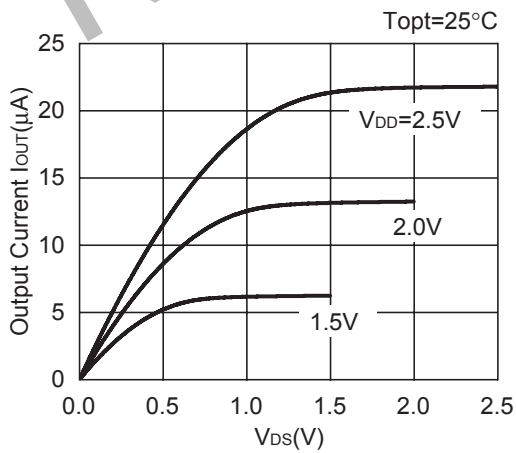

R3113D271C

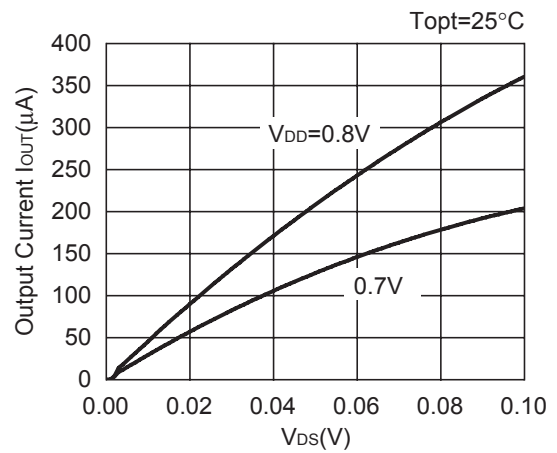

R3113D

Non-prpmotion

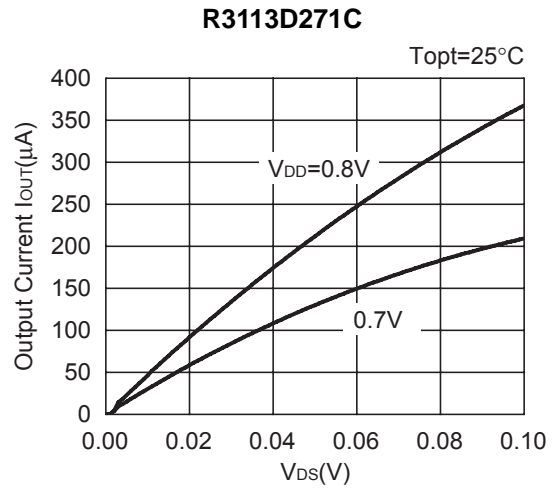
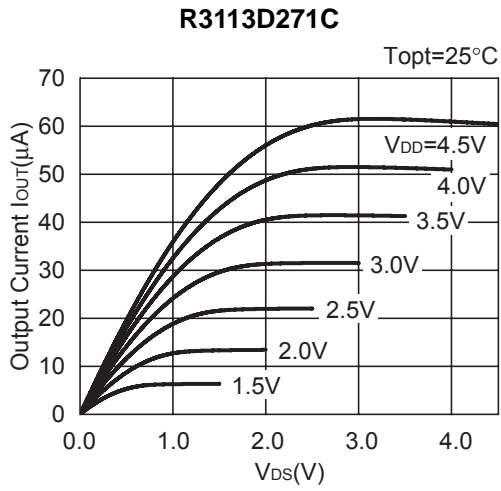

5) Nch Driver Output Current vs. Input Voltage

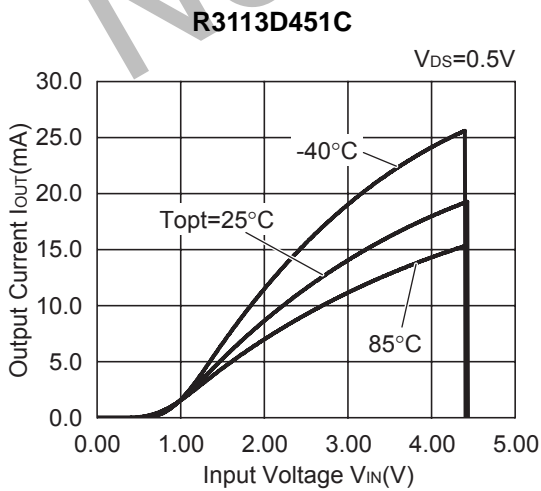
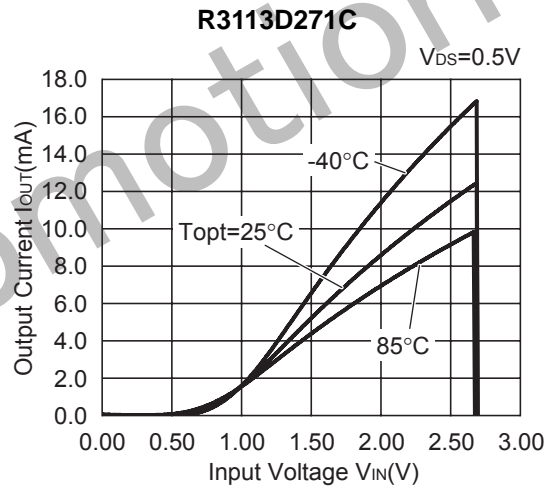
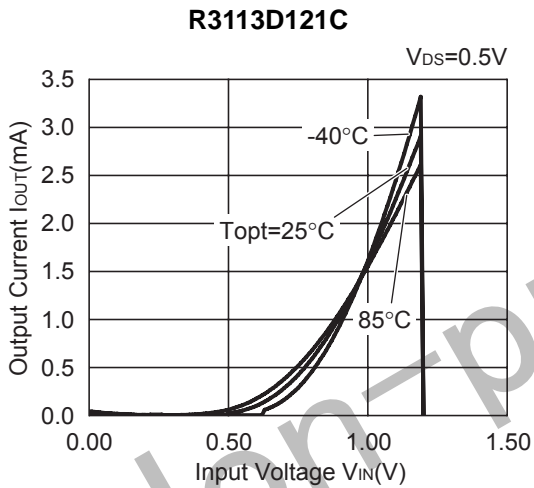

6) Pch Driver Output Current vs. Input Voltage

R3113D121C

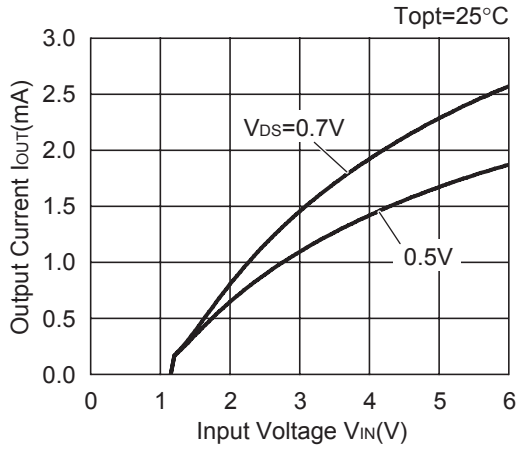

R3113D271C

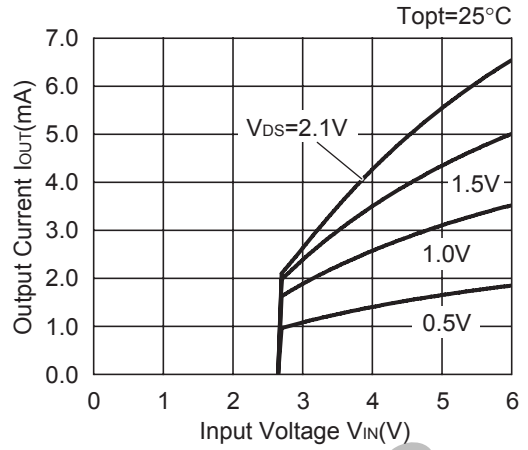

R3113D451C

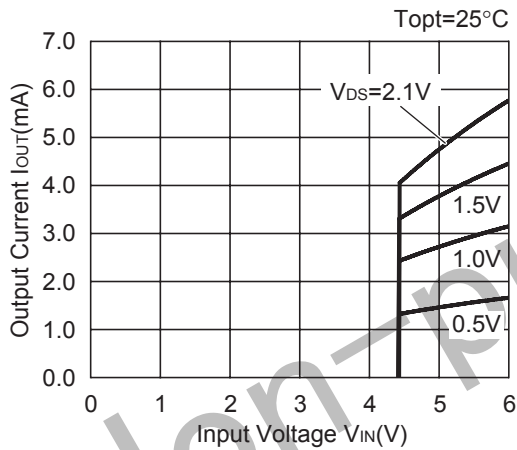

7) Output Delay Time vs. Load Capacitance

R3113D121A

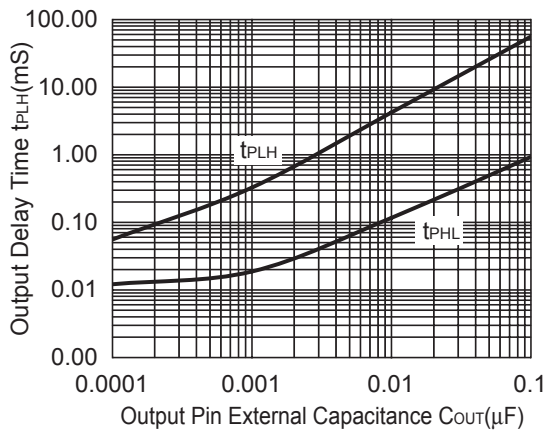

R3113D271A

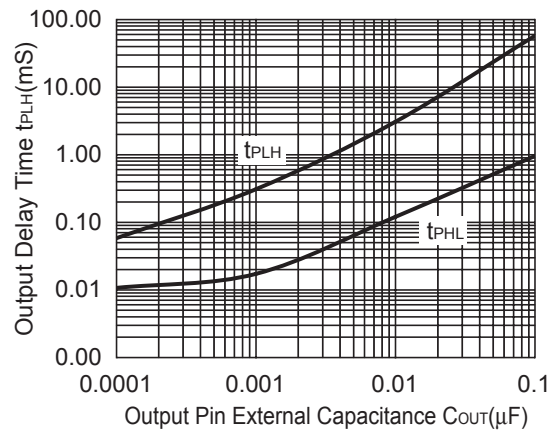

R3113D

Non-prpmotion

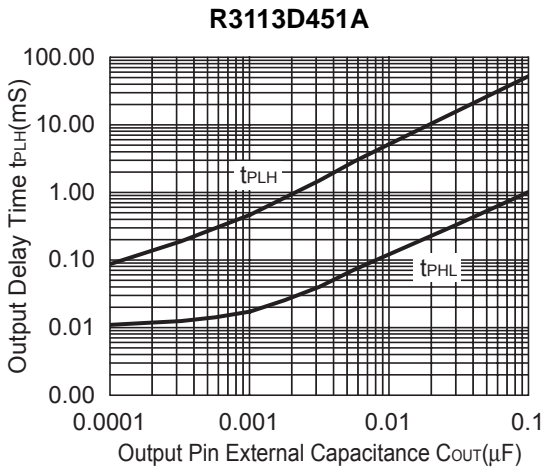

8) Output Delay Time vs. Input Pin Capacitance

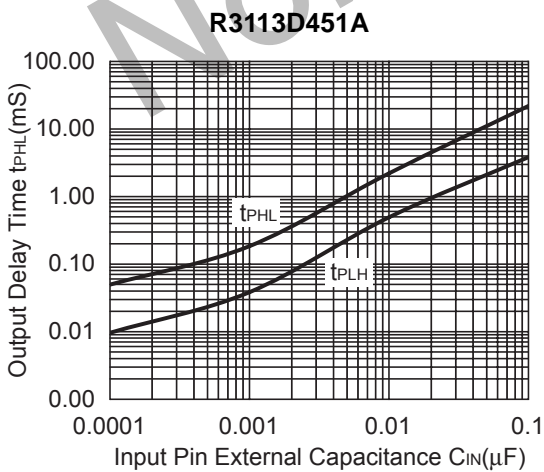
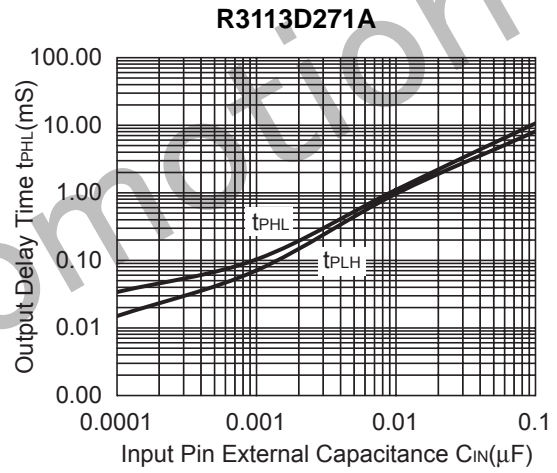
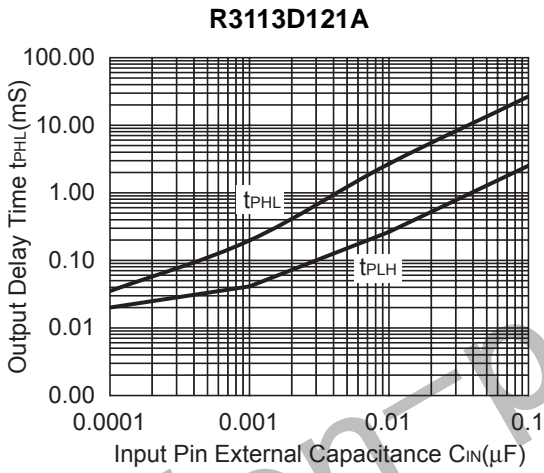

TECHNICAL NOTES

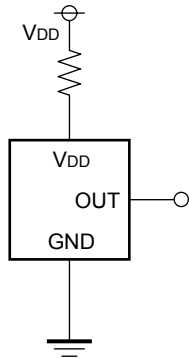

Figure 9

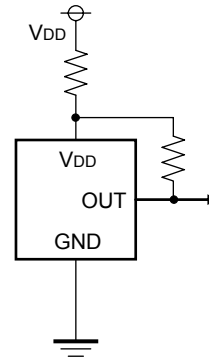

Figure 10

1. In Figure 9, When R3113Dxx1C is used, and if an impedance is connected between Voltage Supplier and the V_{DD} Pin of R3113Dxx1C Series, the operation might be unstable by cross conduction current at detection.
When R3113Dxx1A is used in Figure 9, if the value of R is set excessively large, voltage drop may occur caused by supply current of IC itself and Detector threshold may vary.
2. Wiring as shown in Figure 10 may cause the oscillation in both output types of R3113 Series.



1. The products and the product specifications described in this document are subject to change or discontinuation of production without notice for reasons such as improvement. Therefore, before deciding to use the products, please refer to Ricoh sales representatives for the latest information thereon.
2. The materials in this document may not be copied or otherwise reproduced in whole or in part without prior written consent of Ricoh.
3. Please be sure to take any necessary formalities under relevant laws or regulations before exporting or otherwise taking out of your country the products or the technical information described herein.
4. The technical information described in this document shows typical characteristics of and example application circuits for the products. The release of such information is not to be construed as a warranty of or a grant of license under Ricoh's or any third party's intellectual property rights or any other rights.
5. The products listed in this document are intended and designed for use as general electronic components in standard applications (office equipment, telecommunication equipment, measuring instruments, consumer electronic products, amusement equipment etc.). Those customers intending to use a product in an application requiring extreme quality and reliability, for example, in a highly specific application where the failure or misoperation of the product could result in human injury or death (aircraft, spacevehicle, nuclear reactor control system, traffic control system, automotive and transportation equipment, combustion equipment, safety devices, life support system etc.) should first contact us.
6. We are making our continuous effort to improve the quality and reliability of our products, but semiconductor products are likely to fail with certain probability. In order to prevent any injury to persons or damages to property resulting from such failure, customers should be careful enough to incorporate safety measures in their design, such as redundancy feature, firecontainment feature and fail-safe feature. We do not assume any liability or responsibility for any loss or damage arising from misuse or inappropriate use of the products.
7. Anti-radiation design is not implemented in the products described in this document.
8. Please contact Ricoh sales representatives should you have any questions or comments concerning the products or the technical information.



For the conservation of the global environment, Ricoh is advancing the decrease of the negative environmental impact material.
After Apr. 1, 2006, we will ship out the lead free products only. Thus, all products that will be shipped from now on comply with RoHS Directive. Basically after Apr. 1, 2012, we will ship out the Power Management ICs of the Halogen Free products only. (Ricoh Halogen Free products are also Antimony Free.)

RICOH RICOH COMPANY, LTD. Electronic Devices Company

<http://www.ricoh.com/LSI/>

RICOH COMPANY, LTD.

Electronic Devices Company

● Higashi-Shinagawa Office (International Sales)

3-32-3, Higashi-Shinagawa, Shinagawa-ku, Tokyo 140-8655, Japan
Phone: +81-3-5479-2857 Fax: +81-3-5479-0502

RICOH EUROPE (NETHERLANDS) B.V.

● Semiconductor Support Centre

"Nieuw Kronenburg" Prof. W.H. Keesomlaan 1, 1183 DJ, Amstelveen, The Netherlands
P.O.Box 114, 1180 AC Amstelveen
Phone: +31-20-5474-309 Fax: +31-20-5474-791

RICOH ELECTRONIC DEVICES KOREA Co., Ltd.

11 floor, Haesung 1 building, 942, Daechidong, Gangnamgu, Seoul, Korea
Phone: +82-2-2135-5700 Fax: +82-2-2135-5705

RICOH ELECTRONIC DEVICES SHANGHAI Co., Ltd.

Room403, No.2 Building, 690#Bi Bo Road, Pu Dong New district, Shanghai 201203,
People's Republic of China
Phone: +86-21-5027-3200 Fax: +86-21-5027-3299

RICOH COMPANY, LTD.

Electronic Devices Company

● Taipei office

Room109, 10F-1, No.51, Hengyang Rd., Taipei City, Taiwan (R.O.C.)
Phone: +886-2-2313-1621/1622 Fax: +886-2-2313-1623