

MM1Z4678 - MM1Z4717

V_Z : 1.8 to 43 V
 P_D : 500 mW

FEATURES :

- * Total Power Dissipation 500 mW on FR-4 or FR-5 Board
- * Wide Zener Reverse Voltage Range 1.8 V to 43 V
- * Package Designed for Optimal Automated Board Assembly
- * Small Package Size for High Density Applications
- * **Pb / RoHS Free**

MECHANICAL DATA :

- * Case : SOD-123
- * Weight : 0.01 gram (approximately)

ZENER DIODES

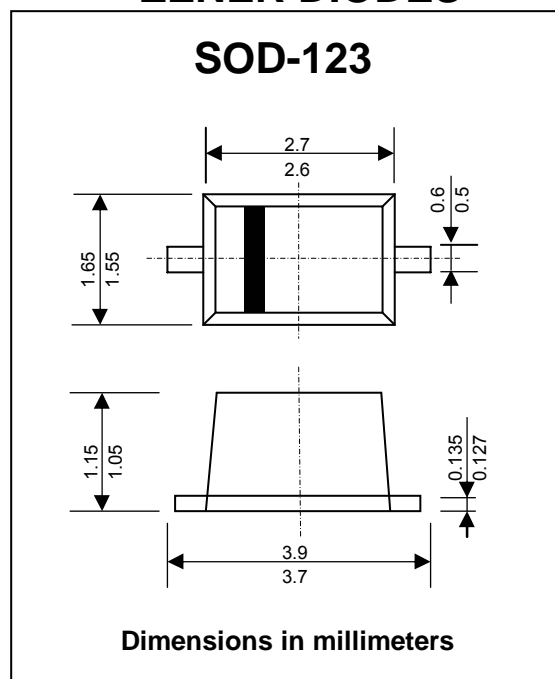

Maximum Ratings and Thermal Characteristics

Rating at 25 °C ambient temperature unless otherwise specified

Parameter	Symbol	Value	Unit
Zener Current see Table "Characteristics"			
Total Power Dissipation on FR-5 Board, at $T_L = 75\text{ °C}$ Derated above 75 °C	P_D	500 ⁽¹⁾ 6.7	mW mW/°C
Maximum Forward Voltage at $I_F = 10\text{ mA}$	V_F	0.9	V
Thermal Resistance Junction to Ambient	$R_{\theta JA}$	340	°C/W
Thermal Resistance Junction to Lead	$R_{\theta JL}$	150	°C/W
Junction Temperature Range	T_J	-55 to + 150	°C
Storage Temperature Range	T_{STG}	-55 to + 150	°C

Note :

(1) FR-5 = 3.5 x 1.5 inches, using the minimum recommended footprint.

ELECTRICAL CHARACTERISTICS

Rating at 25 °C ambient temperature unless otherwise specified

Type No.	Marking	Zener Voltage ^(1,2)			Test Current	Maximum Reverse Leakage Current	
		$V_Z @ I_{ZT}$ (V)				I_{ZT}	$I_R @ V_R$
		Min.	Nom.	Max.	(μA)	(μA)	(V)
MM1Z4678	BC	1.71	1.8	1.89	50	7.5	1.0
MM1Z4679	BD	1.90	2.0	2.10	50	5.0	1.0
MM1Z4680	BE	2.09	2.2	2.31	50	4.0	1.0
MM1Z4681	BF	2.28	2.4	2.52	50	2.0	1.0
MM1Z4682	BH	2.565	2.7	2.835	50	1.0	1.0
MM1Z4683	BJ	2.85	3.0	3.15	50	0.8	1.0
MM1Z4684	BK	3.13	3.3	3.47	50	7.5	1.5
MM1Z4685	BM	3.42	3.6	3.78	50	7.5	2.0
MM1Z4686	BN	3.70	3.9	4.10	50	5.0	2.0
MM1Z4687	BP	4.09	4.3	4.52	50	4.0	2.0
MM1Z4688	BR	4.47	4.7	4.94	50	10	3.0
MM1Z4689	BX	4.85	5.1	5.36	50	10	3.0
MM1Z4690	BY	5.32	5.6	5.88	50	10	4.0
MM1Z4691	BZ	5.89	6.2	6.51	50	10	5.0
MM1Z4692	CA	6.46	6.8	7.14	50	10	5.1
MM1Z4693	CB	7.13	7.5	7.88	50	10	5.7
MM1Z4694	CC	7.79	8.2	8.61	50	1.0	6.2
MM1Z4695	CD	8.27	8.7	9.14	50	1.0	6.6
MM1Z4696	CE	8.65	9.1	9.56	50	1.0	6.9
MM1Z4697	CF	9.50	10	10.50	50	1.0	7.6
MM1Z4698	CH	10.45	11	11.50	50	0.05	8.4
MM1Z4699	CJ	11.40	12	12.60	50	0.05	9.1
MM1Z4700	CK	12.35	13	13.65	50	0.05	9.8
MM1Z4701	CM	13.30	14	14.70	50	0.05	10.6
MM1Z4702	CN	14.25	15	15.75	50	0.05	11.4
MM1Z4703	CP	15.20	16	16.80	50	0.05	12.1
MM1Z4704	CR	16.15	17	17.85	50	0.05	12.9
MM1Z4705	CX	17.10	18	18.90	50	0.05	13.6
MM1Z4706	CY	18.05	19	19.95	50	0.05	14.4
MM1Z4707	CZ	19.00	20	21.00	50	0.01	15.2
MM1Z4708	DA	20.90	22	23.10	50	0.01	16.7
MM1Z4709	DB	22.80	24	25.20	50	0.01	18.2
MM1Z4710	DC	23.75	25	26.25	50	0.01	19.0
MM1Z4711	DD	25.65	27	28.35	50	0.01	20.4
MM1Z4712	DE	26.60	28	29.40	50	0.01	21.2
MM1Z4713	DF	28.50	30	31.50	50	0.01	22.8
MM1Z4714	DH	31.35	33	34.65	50	0.01	25.0
MM1Z4715	DJ	34.20	36	37.80	50	0.01	27.3
MM1Z4716	DK	37.05	39	40.95	50	0.01	29.6
MM1Z4717	DM	40.85	43	45.15	50	0.01	32.6

Notes :

(1) Tested with pulses $t_p = 20$ ms

(2) Nominal Zener voltage is measured with the device junction in thermal equilibrium at $\pm 30^\circ C \pm 1^\circ C$

RATING AND CHARACTERISTIC CURVES (MM1Z4678 - MM1Z4717)

**FIG.1 - TEMPERATURE COEFFICIENTS
(TEMPERATURE RANGE - 55 °C to +150 °C)**

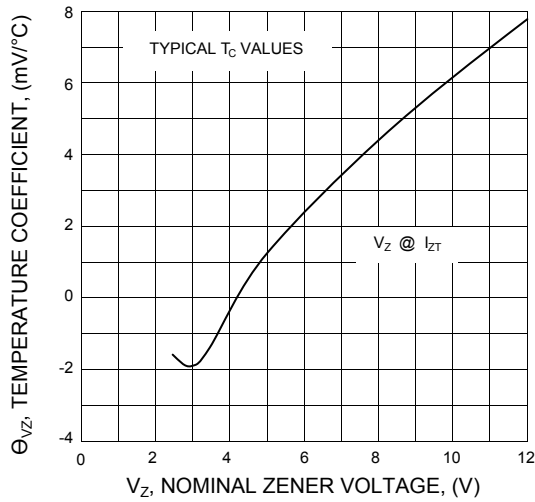

**FIG.2 - TEMPERATURE COEFFICIENTS
(TEMPERATURE RANGE - 55 °C to +150 °C)**

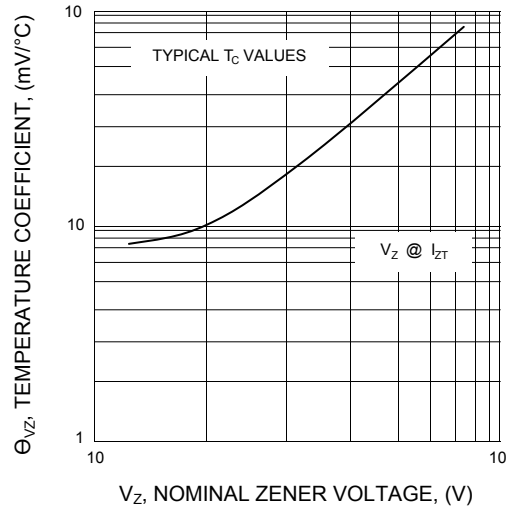

FIG.3 - TYPICAL FORWARD VOLTAGE

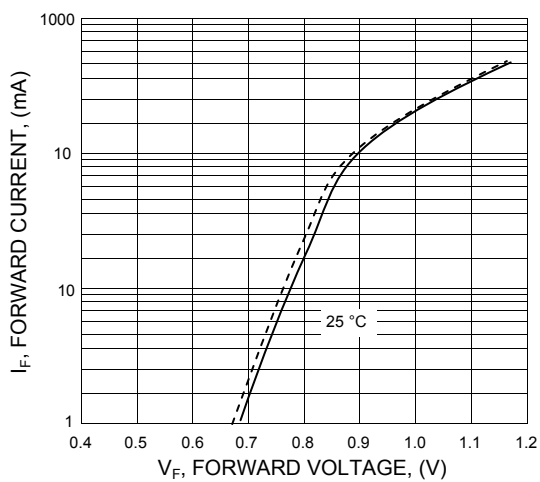
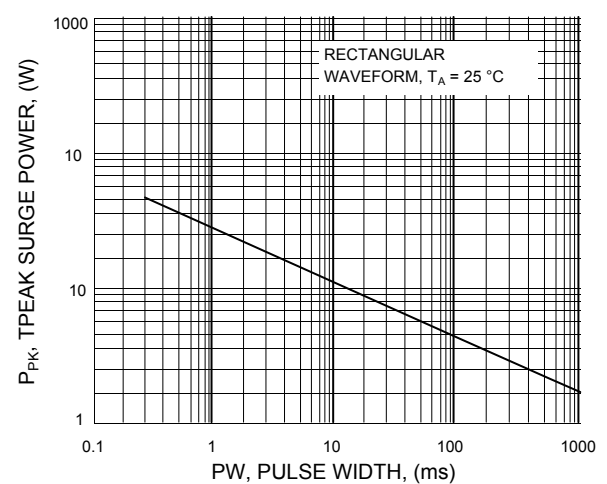

FIG.4 - MAXIMUM NON-REPETITIVE SURGE POWER



RATING AND CHARACTERISTIC CURVES (MM1Z4678 - MM1Z4717)

FIG.5 - ZENER VOLTAGE VS. ZENER CURRENT
(V_Z Up to 12 V)

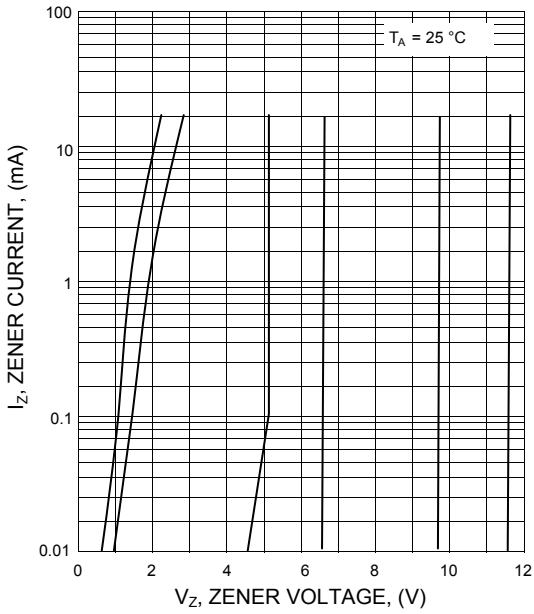

FIG.6 - ZENER VOLTAGE VS. ZENER CURRENT
(V_Z 12 V to 91 V)

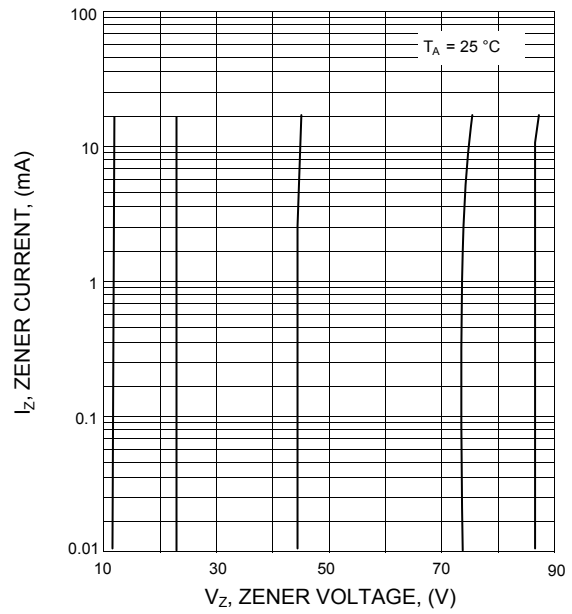

FIG.7 - STEADY STATE POWER DERATING

