

General purpose chip resistors sizes 1206, 0805, 0603 and 0402

RC01/11/21/31
5%; 2%

FEATURES

- Low assembly costs
- High component and equipment reliability
- Excellent performance at high frequency, especially the RC31
- Complete standard SMD family.

APPLICATIONS

- All general purpose applications.

DESCRIPTION

The resistors are constructed on a high grade ceramic body (aluminium oxide). Internal metal electrodes are added at each end and connected by a resistive paste which is applied to the top surface of the substrate. The composition of the paste is adjusted to give the approximate resistance required and the value is trimmed to within tolerance, by laser cutting of this resistive layer.

The resistive layer is covered with a protective coat and printed with the resistance value. Finally, the two external end terminations are added. For ease of soldering the outer layer of these end terminations is a lead/tin alloy.

QUICK REFERENCE DATA

DESCRIPTION	VALUE			
	RC01	RC11	RC21	RC31
Size code	1206 (3216)	0805 (2012)	0603 (1608)	0402(1005)
Resistance range	1 Ω to 10 M Ω			6.8 Ω to 2.2 M Ω
Resistance tolerance and E-series	$\pm 5\%$, $\pm 2\%$; E24 series			
Temperature coefficient: 1 $\Omega \leq R < 10 \Omega$ 10 $\Omega < R \leq 10 \text{ M}\Omega$	$\leq 250 \pm 250 \times 10^{-6}/\text{K}$ $\leq \pm 200 \times 10^{-6}/\text{K}$			
Maximum dissipation at $T_{\text{amb}} = 70 \text{ }^\circ\text{C}$	0.25 W	0.125 W	0.063 W	0.063 W
Maximum permissible voltage	200 V (DC or RMS)	150 V (DC or RMS)	50 V (DC or RMS)	50 V (DC or RMS)
Climatic category (IEC 60068)	55/155/56			55/125/56
Basic specification	IEC 60115-8			

General purpose chip resistors
sizes 1206, 0805, 0603 and 0402

RC01/11/21/31
5%; 2%

ORDERING INFORMATION

Table 1 Ordering code indicating resistor type and packaging

TYPE	TOL. (%)	ORDERING CODE 2322					
		PAPER TAPE ON REEL ⁽¹⁾				BULK CASE	
		5000 units	10000 units	20000 units	50000 units	10000 units	25000 units
RC01	±5	711 61...	711 51...	711 81...	–	–	–
	±2	711 41...	–	711 71...	–	–	–
RC11	±5	730 61...	730 71...	730 81...	–	731 81...	–
	±2	730 31...	–	730 41...	–	731 51...	–
RC21	±5	702 60...	702 70...	702 81...	–	–	702 80...
	±2	702 65...	–	702 75...	–	–	702 50...
RC31	±5	–	705 70...	–	705 87...	–	–
	±2	–	705 75...	–	–	–	702 50...
Jumper 0 Ω							
RC01 ⁽¹⁾	–	711 91032	711 91005	711 92004	–	–	–
RC11 ⁽¹⁾	–	730 91002	730 91003	730 92002	–	731 91006	–
RC21 ⁽²⁾	–	702 96001	702 97001	702 92002	–	–	702 91002
RC31 ⁽²⁾	–	–	705 91001	–	705 91007	–	–

Notes

- The jumper has a maximum resistance $R_{\max} = 50 \text{ m}\Omega$ and a rated current $I_R = 2 \text{ A}$.
- The jumper has a maximum resistance $R_{\max} = 50 \text{ m}\Omega$ and a rated current $I_R = 1 \text{ A}$.

Ordering code (12NC)

- The resistors have a 12-digit ordering code starting with 2322
- The subsequent 5 digits indicate the resistor type and packaging; see Table 1.
- The remaining 3 digits indicate the resistance value:
 - The first 2 digits indicate the resistance value.
 - The last digit indicates the resistance decade in accordance with Table 2.

Table 2 Last digit of 12NC

RESISTANCE DECADE	LAST DIGIT
1 to 9.76 Ω	8
10 to 97.6 Ω	9
100 to 976 Ω	1
1 to 9.76 kΩ	2
10 to 97.6 kΩ	3
100 to 976 kΩ	4
1 to 9.76 MΩ	5
10 MΩ	6

ORDERING EXAMPLE

The ordering code of a RC11 resistor, value 4700 Ω with ±2% tolerance, supplied on paper tape of 5000 units per reel is: 2322 730 31472.

General purpose chip resistors
 sizes 1206, 0805, 0603 and 0402

RC01/11/21/31
 5%; 2%

FUNCTIONAL DESCRIPTION

Product characterization

Standard values of nominal resistance are taken from the E24 series for resistors with a tolerance of $\pm 5\%$ or $\pm 2\%$. The values of the E24 series are in accordance with "IEC publication 60063".

Limiting values

TYPE	LIMITING VOLTAGE ⁽¹⁾ (V)	LIMITING POWER (W)
RC01	200	0.25
RC11	150	0.125
RC21	50	0.063
RC31		

Note

1. This is the maximum voltage that may be continuously applied to the resistor element, see "IEC publication 60115-8".

DERATING

The power that the resistor can dissipate depends on the operating temperature; see Fig.1.

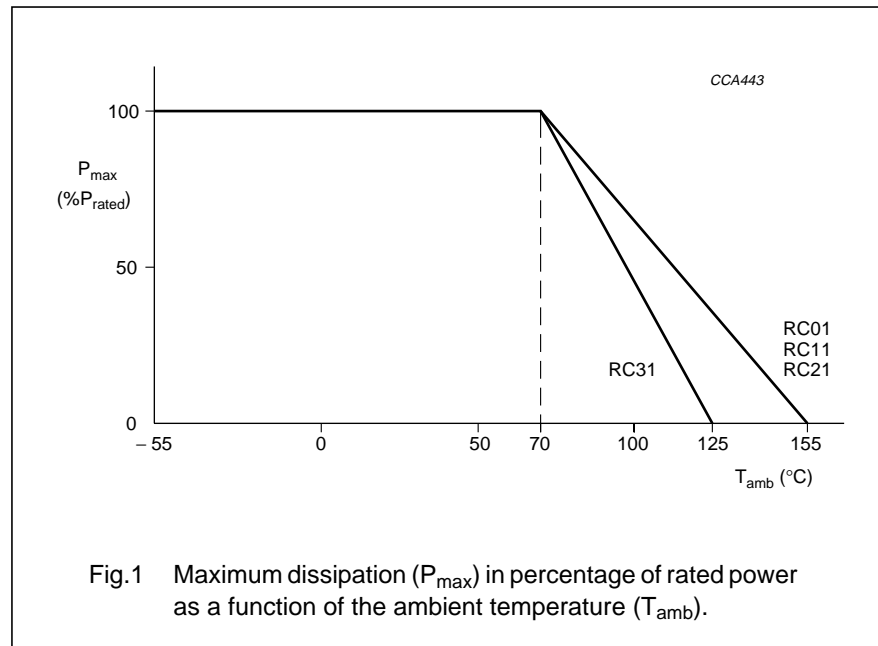
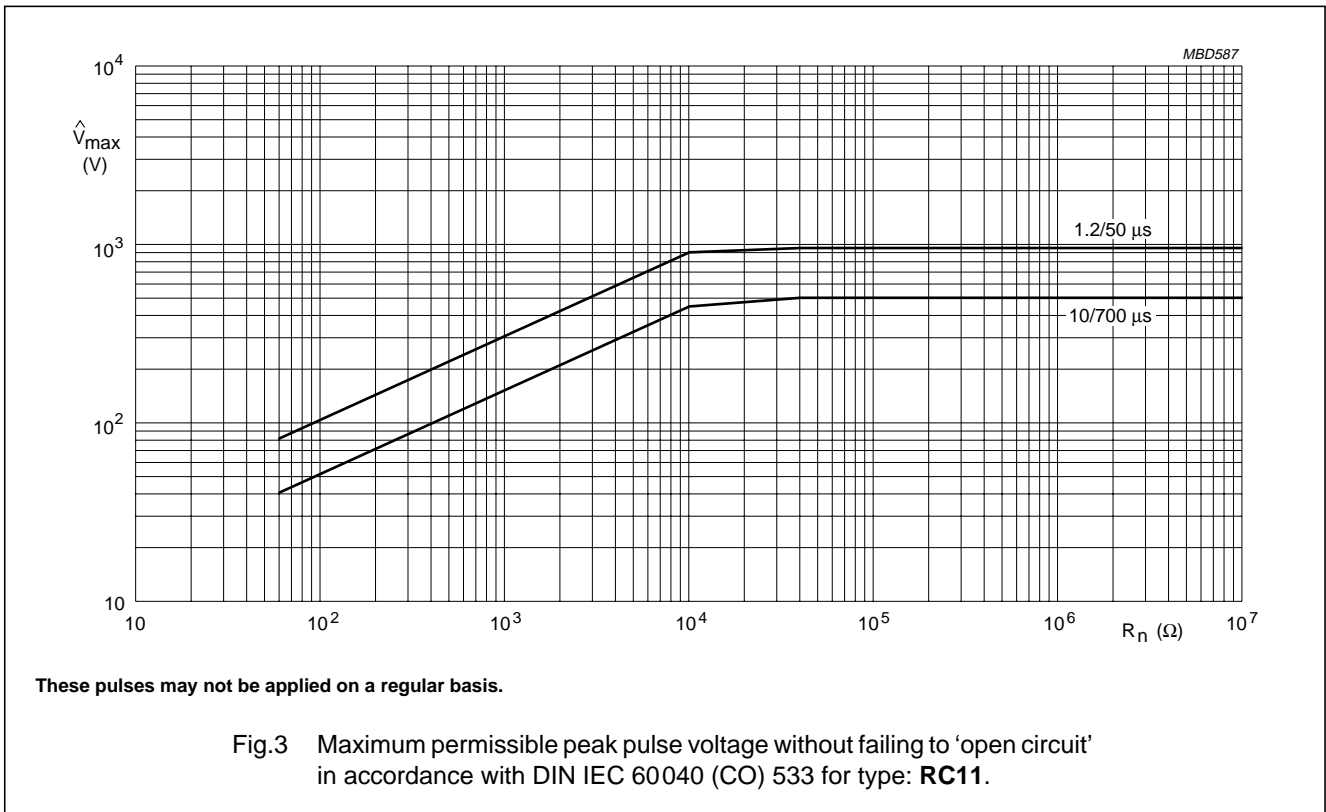
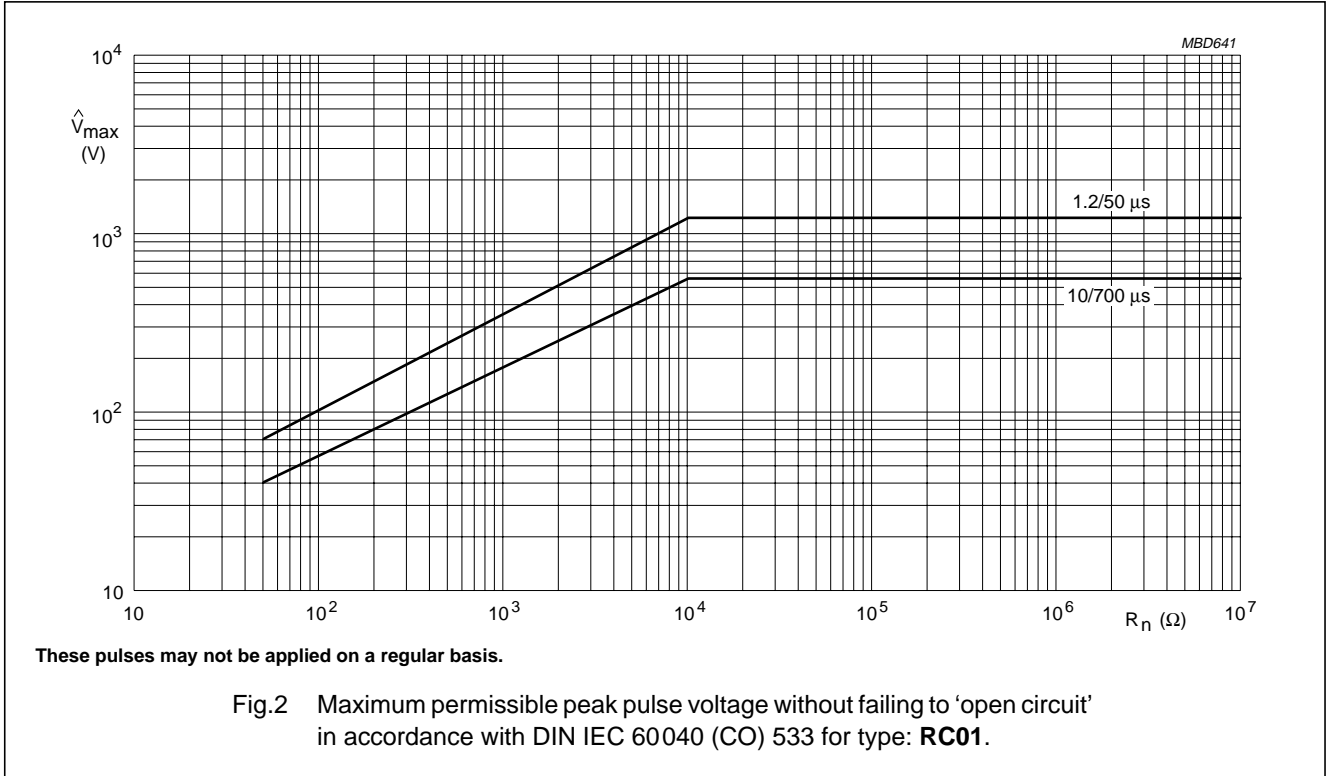

Fig.1 Maximum dissipation (P_{max}) in percentage of rated power as a function of the ambient temperature (T_{amb}).

General purpose chip resistors
sizes 1206, 0805, 0603 and 0402

RC01/11/21/31
5%; 2%

PULSE LOADING CAPABILITIES



General purpose chip resistors
 sizes 1206, 0805, 0603 and 0402

RC01/11/21/31
 5%; 2%

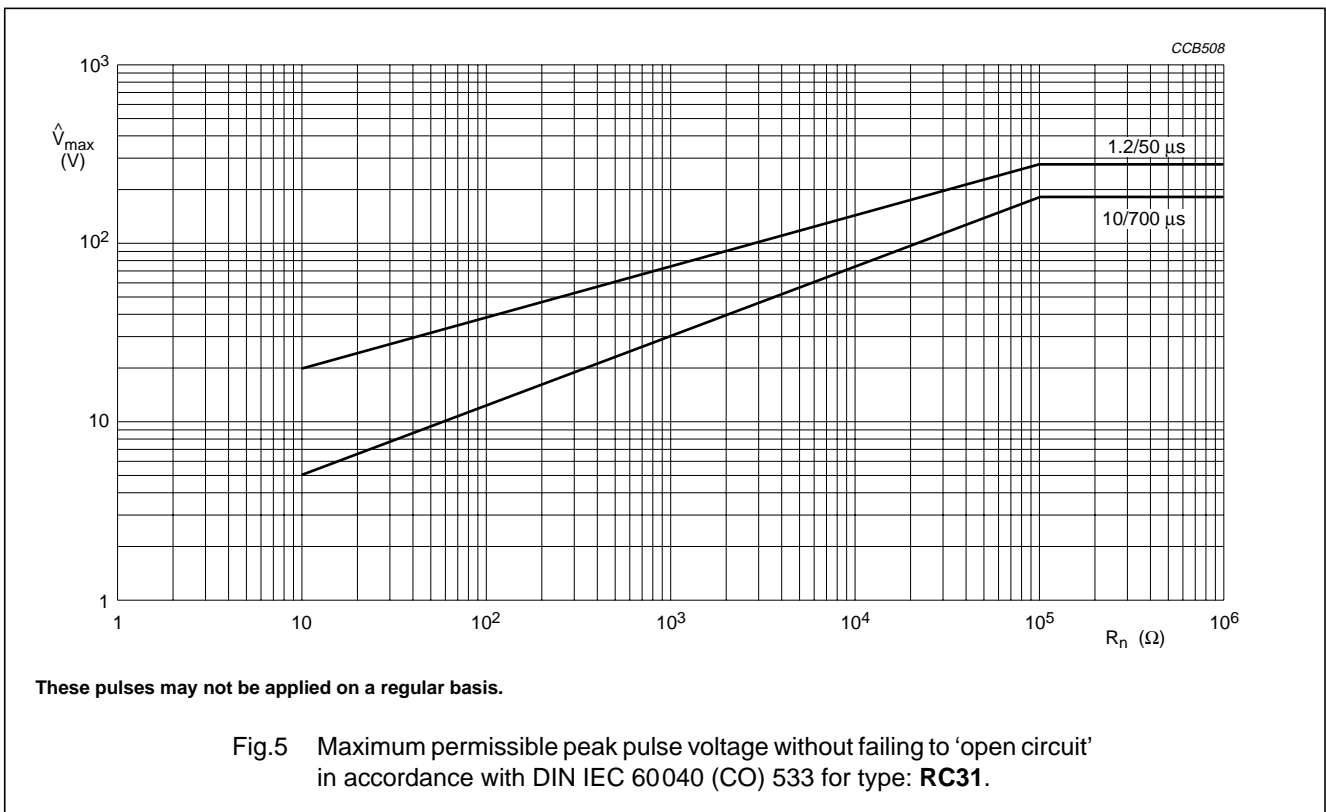
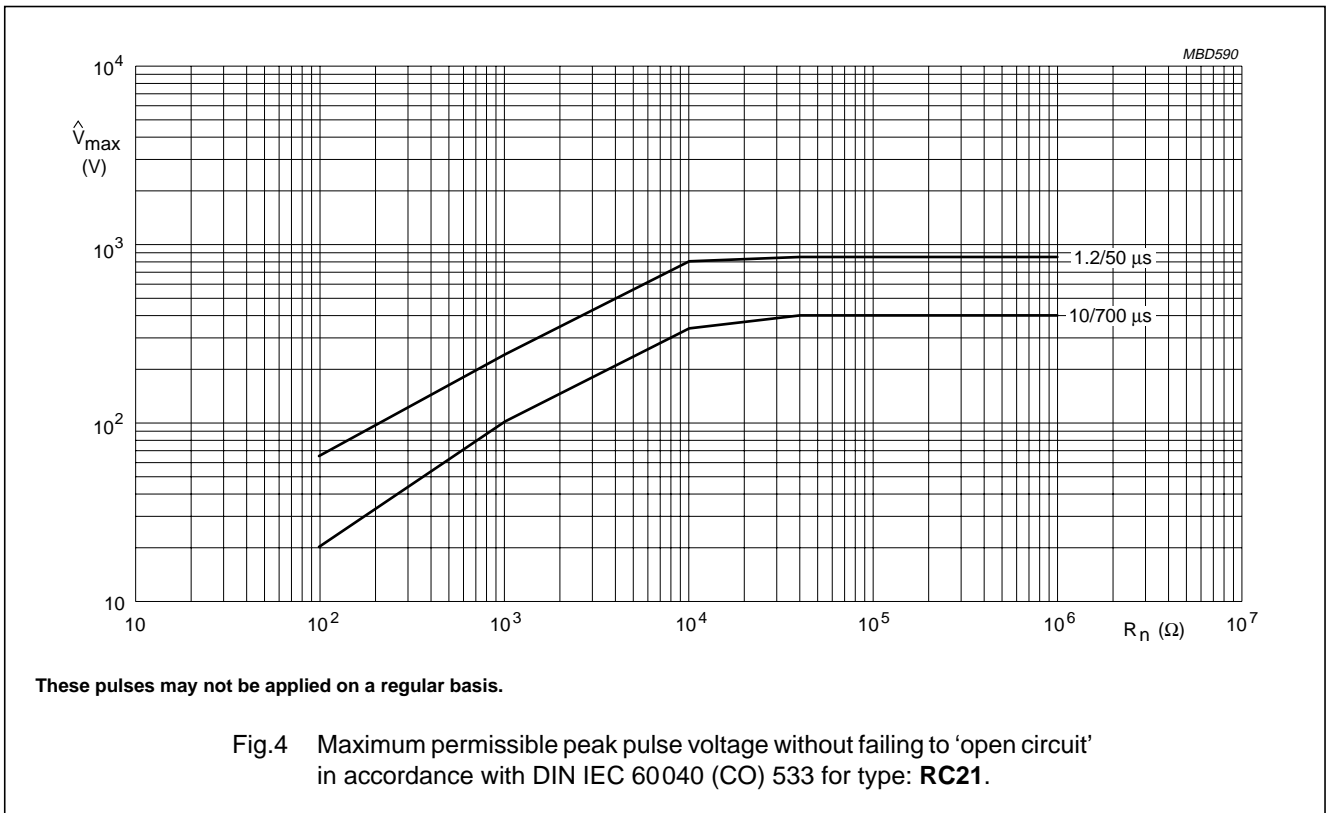

General purpose chip resistors
sizes 1206, 0805, 0603 and 0402

RC01/11/21/31
5%; 2%

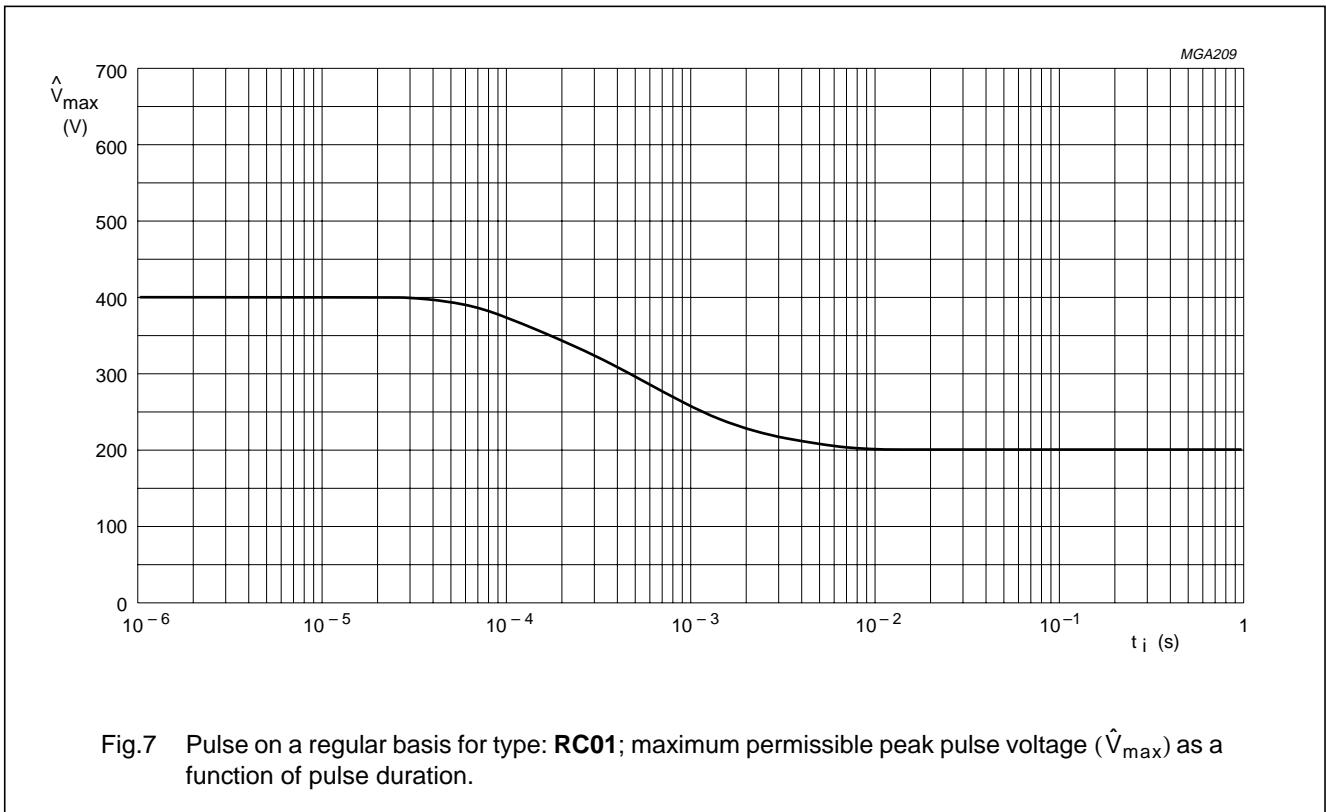
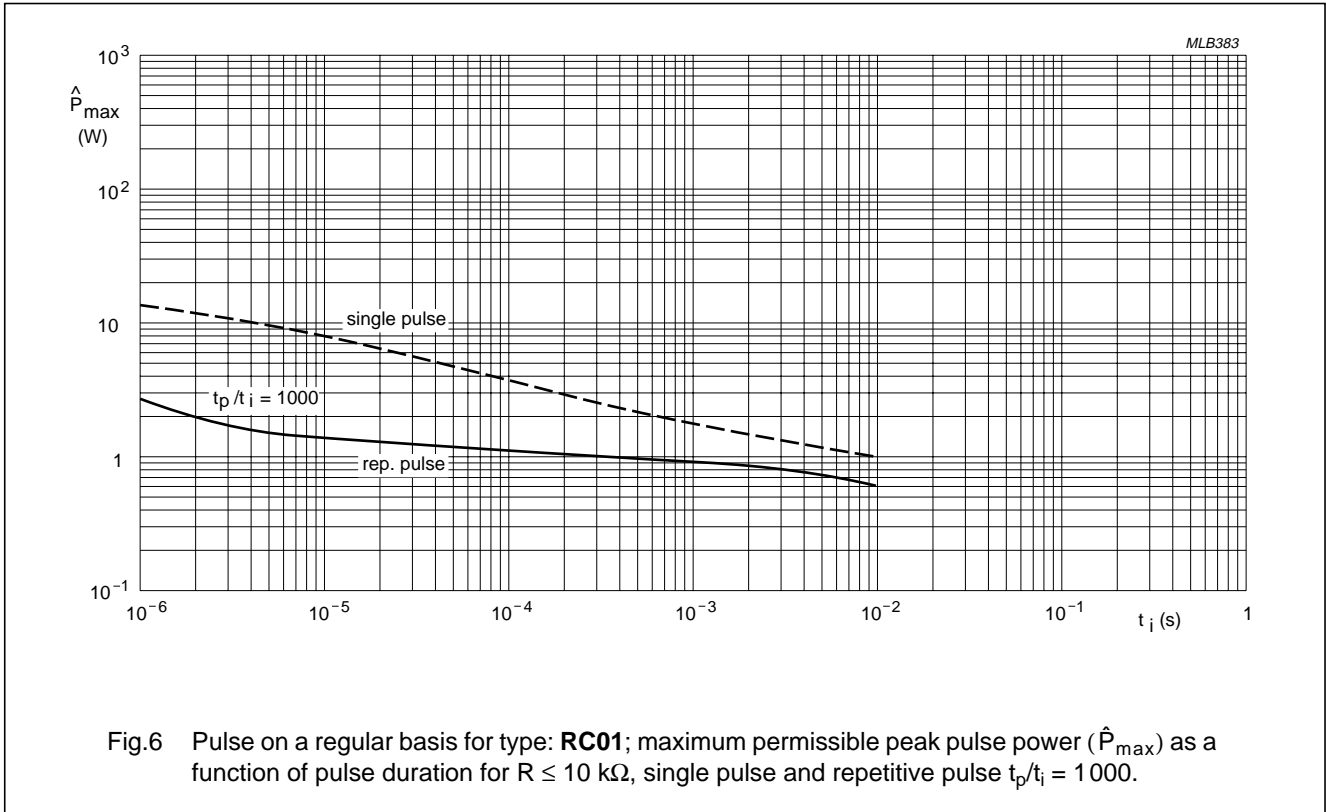

General purpose chip resistors
 sizes 1206, 0805, 0603 and 0402

RC01/11/21/31
 5%; 2%

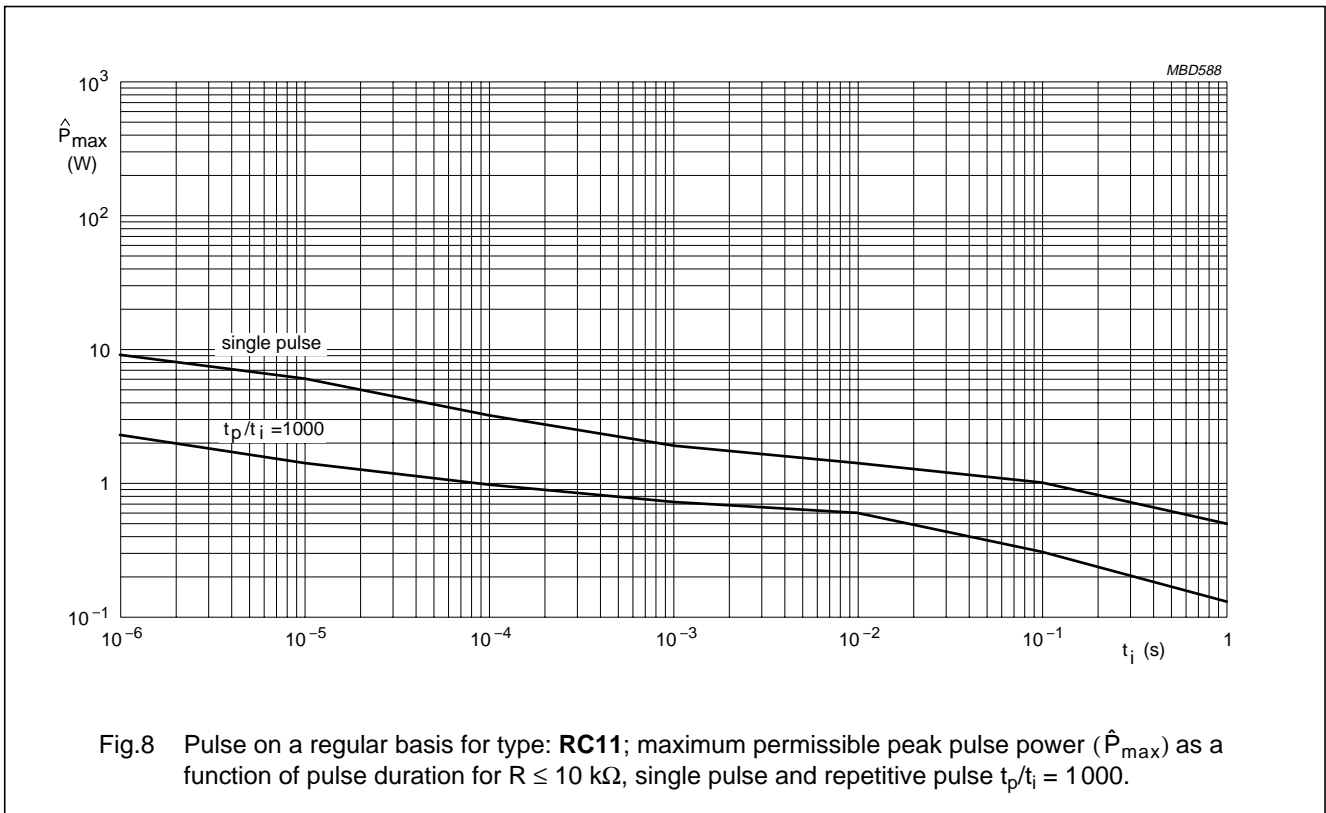

Fig.8 Pulse on a regular basis for type: **RC11**; maximum permissible peak pulse power (\hat{P}_{max}) as a function of pulse duration for $R \leq 10 \text{ k}\Omega$, single pulse and repetitive pulse $t_p/t_i = 1000$.

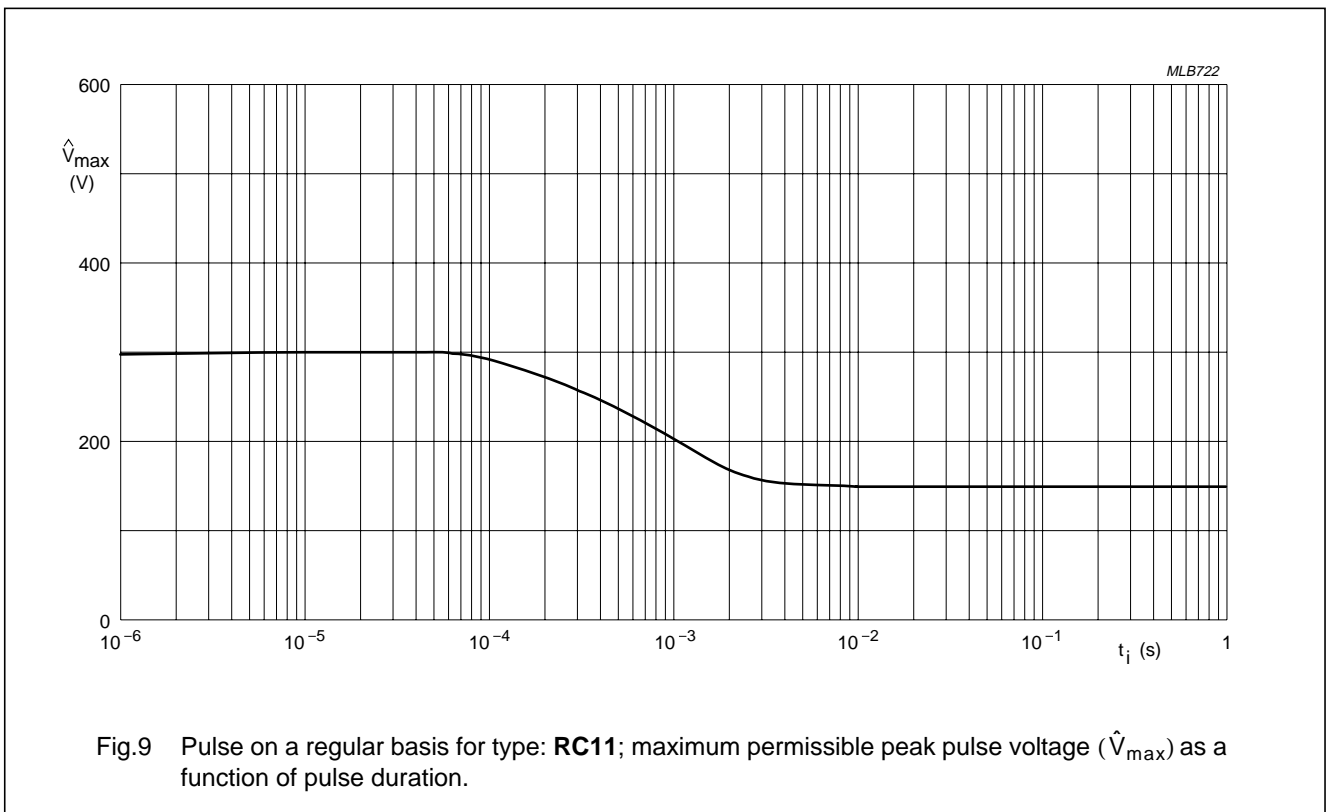

Fig.9 Pulse on a regular basis for type: **RC11**; maximum permissible peak pulse voltage (\hat{V}_{max}) as a function of pulse duration.

General purpose chip resistors
 sizes 1206, 0805, 0603 and 0402

RC01/11/21/31
 5%; 2%

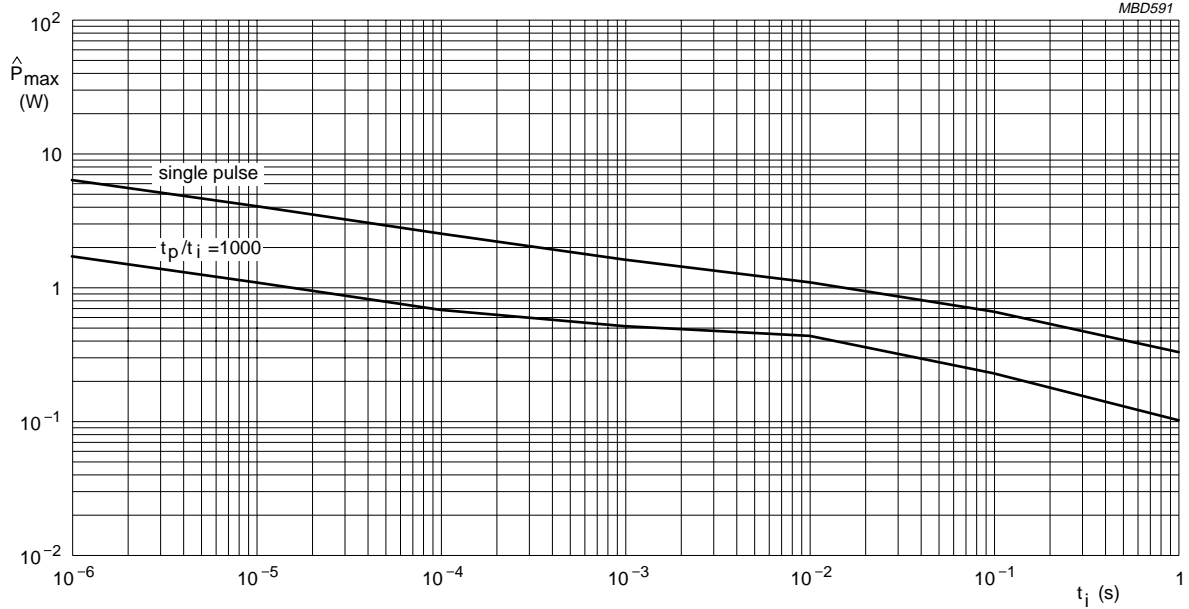

Fig.10 Pulse on a regular basis for type: **RC21**; maximum permissible peak pulse power (\hat{P}_{max}) as a function of pulse duration for $R \leq 10 \text{ k}\Omega$, single pulse and repetitive pulse $t_p/t_i = 1000$.

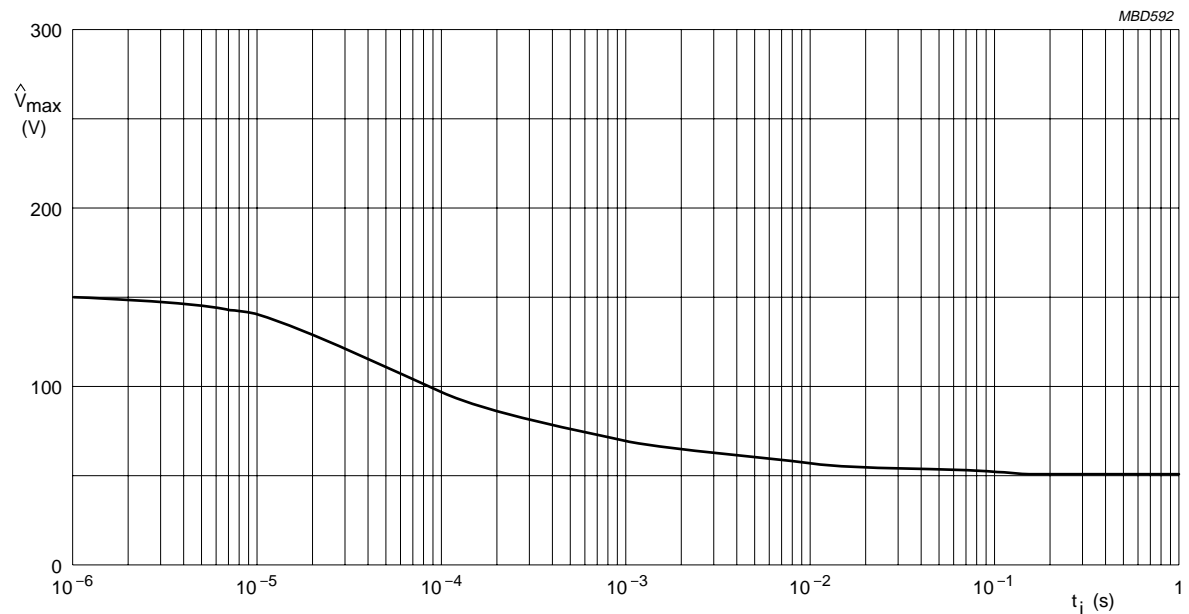
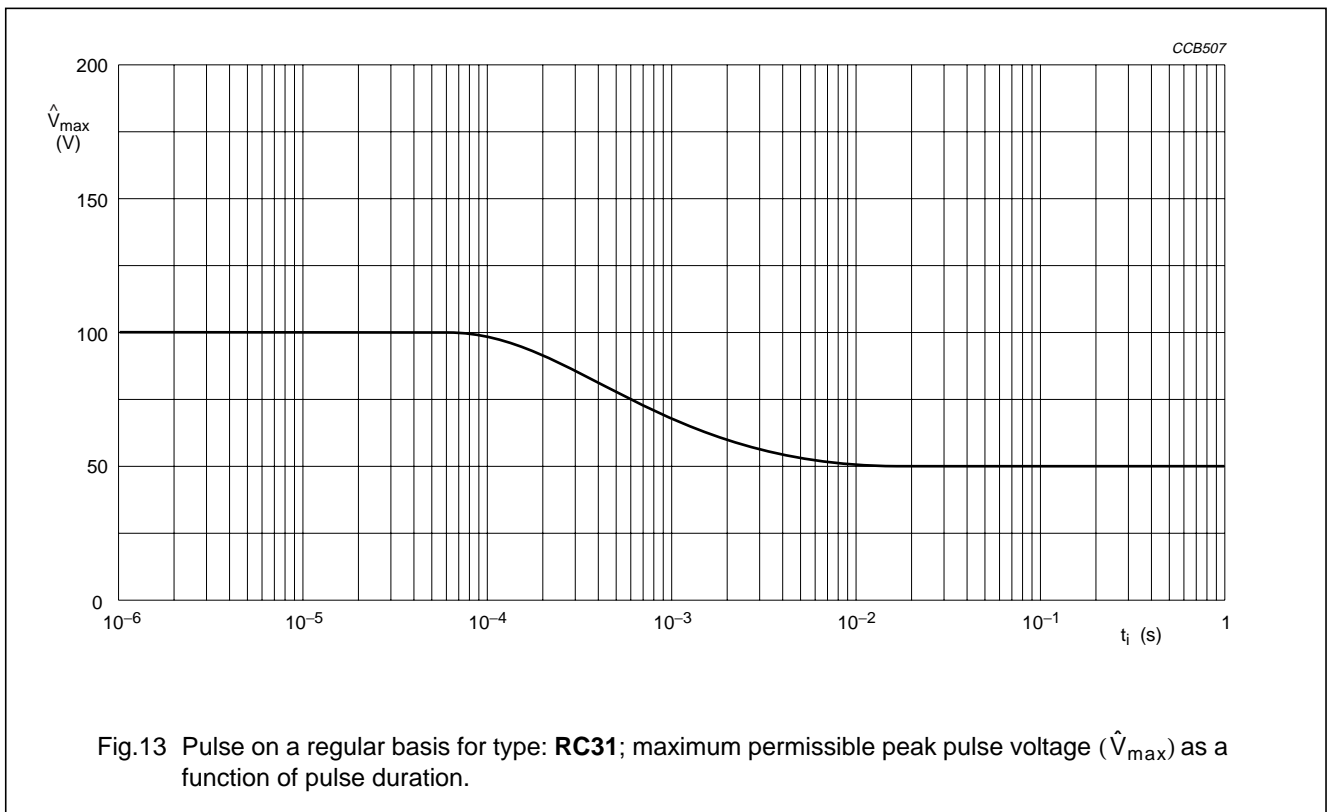
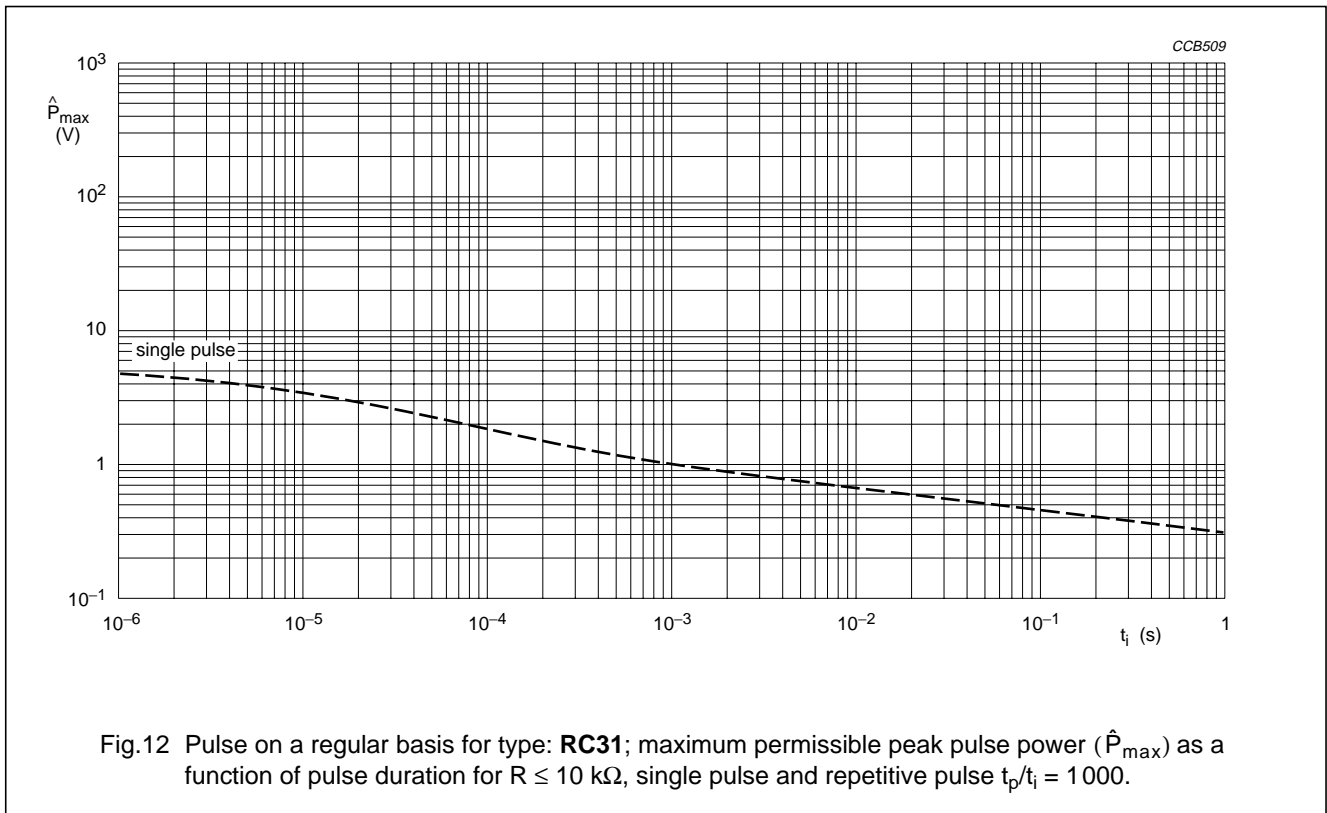

Fig.11 Pulse on a regular basis for type: **RC21**; maximum permissible peak pulse voltage (\hat{V}_{max}) as a function of pulse duration.

General purpose chip resistors
 sizes 1206, 0805, 0603 and 0402

RC01/11/21/31
 5%; 2%



General purpose chip resistors
sizes 1206, 0805, 0603 and 0402

RC01/11/21/31
5%; 2%

MECHANICAL DATA

Mass per 100 units

TYPE	MASS (g)
RC01	1.0
RC11	0.55
RC21	0.25
RC31	0.052

Marking

Each resistor, except RC31, is marked with a three digit code (occasionally four digit) on the protective coating to designate the nominal resistance value.

3-DIGIT MARKING

For values up to 91 Ω the R is used as a decimal point. For values of 100 Ω or greater the first 2 digits are significant, the third indicates the number of zeros to follow.

Example

MARKING	RESISTANCE
12R	12 Ω
823	82 kΩ

4-DIGIT MARKING

For values up to 976 Ω the R is used as a decimal point. For values of 1 kΩ or greater the first 3 digits are significant, the fourth indicates the number of zeros to follow.

Example

MARKING	RESISTANCE
12R0	12 Ω
8202	82 kΩ

PACKAGE MARKING

The packaging is also marked and includes resistance value, tolerance, catalogue number, quantity, production period, batch number and source code.

Outlines

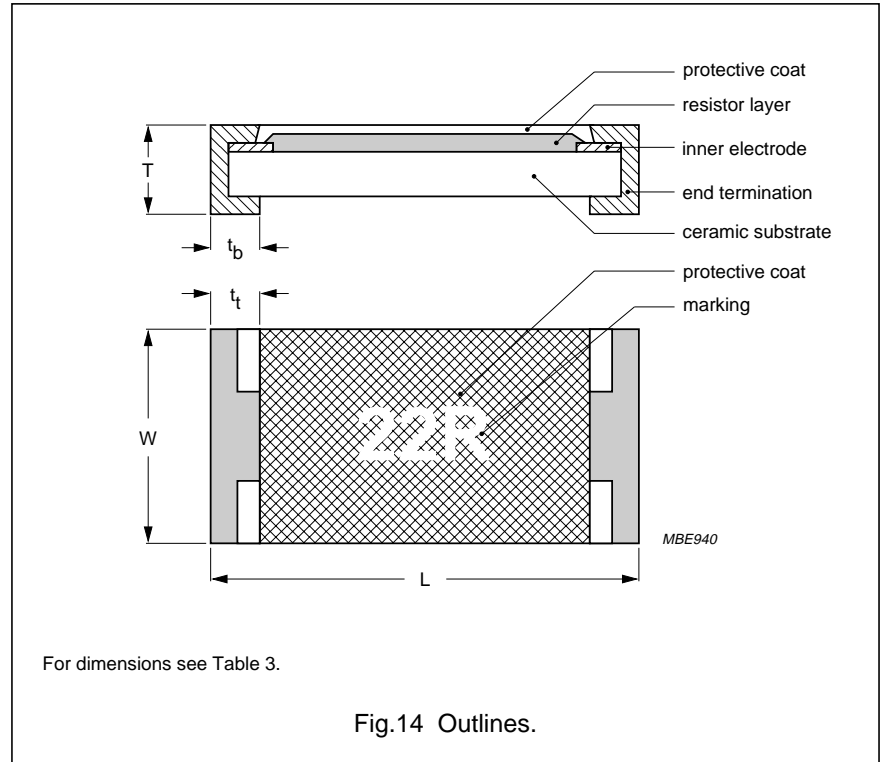

Table 3 Chip resistor types and relevant physical dimensions; see Fig.14

TYPE	L (mm)	W (mm)	T (mm)	t _t (mm)	t _b (mm)
RC01	3.20 +0.10/-0.20	1.60 ±0.15	0.55 ±0.10	0.45 ±0.25	0.50 ±0.25
RC11	2.00 ±0.15	1.25 ±0.15	0.55 ±0.10	0.40 ±0.20	0.40 ±0.20
RC21	1.60 ±0.10	0.80 +0.15/-0.05	0.45 ±0.10	0.30 ±0.20	0.30 ±0.20
RC31	1.00 ±0.05	0.50 ±0.05	0.35 ±0.05	0.20 ±0.10	0.25 ±0.10

General purpose chip resistors
sizes 1206, 0805, 0603 and 0402

RC01/11/21/31
5%; 2%

TESTS AND REQUIREMENTS

Essentially all tests are carried out in accordance with the schedule of "IEC publication 60115-8", category **LCT/UCT/56** (rated temperature range: Lower Category Temperature, Upper Category Temperature; damp heat, long term, **56** days). The testing also covers the requirements specified by EIA and EIAJ.

The tests are carried out in accordance with IEC publication 60068, "Recommended basic climatic and mechanical robustness testing procedure for electronic components" and under standard atmospheric conditions according to "IEC 60068-1", subclause 5.3.

Unless otherwise specified the following values apply:

Temperature: 15 °C to 35 °C

Relative humidity: 45% to 75%

Air pressure: 86 kPa to 106 kPa (860 mbar to 1060 mbar).

In Table 4 the tests and requirements are listed with reference to the relevant clauses of "IEC publications 60115-8 and 60068"; a short description of the test procedure is also given. In some instances deviations from the IEC recommendations were necessary for our method of specifying.

All soldering tests are performed with mildly activated flux.

Table 4 Test procedures and requirements

IEC 60115-8 CLAUSE	IEC 60068-2 TEST METHOD	TEST	PROCEDURE	REQUIREMENTS			
				RC01	RC11	RC21	RC31
Tests in accordance with the schedule of IEC publication 60115-8							
4.4.1		visual examination		no holes; clean surface; no visible damage			
4.4.2		dimensions (see Fig.14)	gauge (mm)	see Table 3			
4.5		resistance	applied voltage (+0/-10%): R < 10 Ω: 0.1 V 10 Ω ≤ R < 100 Ω: 0.3 V 100 Ω ≤ R < 1 kΩ: 1 V 1 kΩ ≤ R < 10 kΩ: 3 V 10 kΩ ≤ R < 100 kΩ: 10 V 100 kΩ ≤ R < 1 MΩ: 25 V R ≥ 1 MΩ: 50 V	R – R _{nom} : max. ±2% or R – R _{nom} : max. ±5%			
4.18	20 (Tb)	resistance to soldering heat	unmounted chips; 10 ±1 s; 260 ±5 °C	no visible damage ΔR/R max.: ±(0.5% +0.05 Ω)		no visible damage ΔR/R max.: ±(1% +0.05 Ω)	
4.29	45 (Xa)	component solvent resistance	isopropyl alcohol or H ₂ O followed by brushing in accordance with "MIL 202 F"	no visible damage			

General purpose chip resistors
sizes 1206, 0805, 0603 and 0402

RC01/11/21/31
5%; 2%

IEC 60115-8 CLAUSE	IEC 60068-2 TEST METHOD	TEST	PROCEDURE	REQUIREMENTS			
				RC01	RC11	RC21	RC31
4.17	20 (Ta)	solderability	unmounted chips completely immersed for 2 ± 0.5 s in a solder bath at 235 ± 2 °C	good tinning ($\geq 95\%$ covered); no visible damage			
4.7		voltage proof on insulation	maximum voltage (RMS) during 1 minute metal block method	no breakdown or flashover			
4.13		short time overload	room temperature; $P = 6.25 \times P_n$; 5 s ($V \leq 2 \times V_{max}$)	$\Delta R/R$ max.: $\pm(1\% + 0.05 \Omega)$		$\Delta R/R$ max.: $\pm(2\% + 0.1 \Omega)$	
4.33		bending	resistors mounted on a 90 mm glass epoxy resin PCB (FR4), bending: 3 mm for RC01 and 5 mm for RC11 , RC21 and RC31	no visible damage; $\Delta R/R$ max.: $\pm(1\% + 0.05 \Omega)$			
4.19	14 (Na)	rapid change of temperature	30 minutes at LCT and 30 minutes at UCT; 5 cycles	no visible damage; $\Delta R/R$ max.: $\pm(0.5\% + 0.05 \Omega)$		no visible damage; $\Delta R/R$ max.: $\pm(2\% + 0.1 \Omega)$	
4.24.2	3 (Ca)	damp heat (steady state)	56 days; 40 ± 2 °C; 93 $\pm 2/-3\%$ RH; loaded with $0.01 P_n$: $R \leq 1 M\Omega$ $R > 1 M\Omega$	$\Delta R/R$ max.: $\pm(1.5\% + 0.1 \Omega)$ $\Delta R/R$ max.: $\pm(3\% + 0.1 \Omega)$		$\Delta R/R$ max.: $\pm(3\% + 0.1 \Omega)$ –	
4.25.1		endurance	1000 $+48/-0$ hours; loaded with P_n or V_{max} ; 1.5 hours on and 0.5 hours off: $R \leq 1 M\Omega$ $R > 1 M\Omega$	$\Delta R/R$ max.: $\pm(1.5\% + 0.1 \Omega)$ $\Delta R/R$ max.: $\pm(3\% + 0.1 \Omega)$		$\Delta R/R$ max.: $\pm(3\% + 0.1 \Omega)$ –	
4.23.2	27 (Ba)	endurance at upper category temperature	1000 $+48/-0$ hours; no load: $R \leq 1 M\Omega$ $R > 1 M\Omega$	$\Delta R/R$ max.: $\pm(1.5\% + 0.1 \Omega)$ $\Delta R/R$ max.: $\pm(3\% + 0.1 \Omega)$		$\Delta R/R$ max.: $\pm(3\% + 0.1 \Omega)$ –	
4.8.4.2		temperature coefficient	at 20/LCT/20 °C and 20/UCT/20 °C: $R \leq 10 \Omega$ $10 \Omega < R$	$\leq 250 \pm 250 \times 10^{-6}/K$ $\leq \pm 200 \times 10^{-6}/K$			

General purpose chip resistors
sizes 1206, 0805, 0603 and 0402

RC01/11/21/31
5%; 2%

IEC 60115-8 CLAUSE	IEC 60068-2 TEST METHOD	TEST	PROCEDURE	REQUIREMENTS			
				RC01	RC11	RC21	RC31
Other tests in accordance with IEC 60115 clauses and IEC 60068 test method							
4.17	20 (Ta)	solderability (after ageing)	8 hours steam or 16 hours 155 °C; unmounted chips completely immersed for 2 ±0.5 s in a solder bath at 235 ±2 °C	good tinning (≥95% covered); no visible damage			
4.6.1.1		insulation resistance	voltage (DC) after 1 minute, metal block method: 100 V for RC01 and RC11 , 50 V for RC21 and RC31	R _{ins} min.: 10 ³ MΩ			
4.12		noise	IEC publication 60195 (measured with Quantech - equipment): R ≤ 100 Ω 100 Ω < R ≤ 1 kΩ 1 kΩ < R ≤ 10 kΩ 10 kΩ < R ≤ 100 kΩ 100 kΩ < R ≤ 1 MΩ 1 MΩ < R ≤ 10 MΩ	max. 0.316 μV/V (-10 dB) max. 1 μV/V (0 dB) max. 3 μV/V (9.54 dB) max. 6 μV/V (15.56 dB) max. 10 μV/V (20 dB) max. 32 μV/V (30.10 dB)			
Other applicable tests							
	(JIS) C 5202 7.5	resistance to damp heat (steady state)	1000 +48/-0 hours; 40 ±2 °C; 93 +2/-3% RH; loaded with P _n or V _{max} ; 1.5 hours on and 0.5 hours off: R ≤ 1 MΩ R > 1 MΩ	ΔR/R max.: ±(3% +0.1 Ω) ΔR/R max.: ±(5% +0.1 Ω)			
		leaching	unmounted chips; 60 ±1 s; 260 ±5 °C	good tinning; no leaching			
		trio damp heat test	1 000 +48/-0 hours; 85 ±2 °C; 85 ±5% RH; loaded with 0.01 P _n or V _{max} R ≤ 1 MΩ R > 1 MΩ	ΔR/R max.: ±(3% +0.1 Ω) ΔR/R max.: ±(5% +0.1 Ω)			