



## Zener diode

### Features

1. Small surface mounting type
2. High reliability



### Applications

Voltage stabilization

### Absolute Maximum Ratings

$T_j=25^{\circ}\text{C}$

Parameter	Test Conditions	Type	Symbol	Value	Unit
Power dissipation	$R_{thJA} \leq 300\text{K/W}$		$P_V$	500	mW
Z-current			$I_Z$	$P_V/V_Z$	mA
Junction temperature			$T_j$	175	$^{\circ}\text{C}$
Storage temperature range			$T_{stg}$	-65~+175	$^{\circ}\text{C}$

### Maximum Thermal Resistance

$T_j=25^{\circ}\text{C}$

Parameter	Test Conditions	Symbol	Value	Unit
Junction ambient	on PC board 50mm × 50mm × 1.6mm	$R_{thJA}$	500	K/W

Stresses exceeding maximum ratings may damage the device. Maximum ratings are stress ratings only. Functional operation above the recommended operating conditions is not implied. Extended exposure to stresses above the recommended operating conditions may affect device reliability.

### Electrical Characteristics

$T_j=25^{\circ}\text{C}$

Parameter	Test Conditions	Type	Symbol	Min	Typ	Max	Unit
Forward voltage	$I_F=200\text{mA}$		$V_F$			1.5	V



Type	V <sub>Znom</sub>	I <sub>ZT</sub>	for V <sub>ZT</sub> and	r <sub>ZT</sub>	r <sub>ZK</sub> at	I <sub>ZK</sub>	I <sub>R</sub> and	I <sub>R</sub> at	V <sub>R</sub>	TK <sub>VZ</sub>
ZMM55B	V	mA	V <sup>1)</sup>	Ω	Ω	mA	μ A	μ A <sup>2)</sup>	V	%/K
2V4	2.4	5	2.35~2.45	<85	<600	1	<50	<100	1	-0.09~-0.06
2V7	2.7	5	2.64~2.76	<85	<600	1	<10	<50	1	-0.09~-0.06
3V0	3.0	5	2.94~3.06	<85	<600	1	<4	<40	1	-0.08~-0.05
3V3	3.3	5	3.24~3.36	<85	<600	1	<2	<40	1	-0.08~-0.05
3V6	3.6	5	3.52~3.68	<85	<600	1	<2	<40	1	-0.08~-0.05
3V9	3.9	5	3.82~3.98	<85	<600	1	<2	<40	1	-0.08~-0.05
4V3	4.3	5	4.22~4.38	<75	<600	1	<1	<20	1	-0.06~-0.03
4V7	4.7	5	4.6~4.8	<60	<600	1	<0.5	<10	1	-0.05~+0.02
5V1	5.1	5	5.0~5.2	<35	<550	1	<0.1	<2	1	-0.02~+0.02
5V6	5.6	5	5.48~5.72	<25	<450	1	<0.1	<2	1	-0.05~+0.05
6V2	6.2	5	6.08~6.32	<10	<200	1	<0.1	<2	2	0.03~0.06
6V8	6.8	5	6.66~6.94	<8	<150	1	<0.1	<2	3	0.03~0.07
7V5	7.5	5	7.35~7.65	<7	<50	1	<0.1	<2	5	0.03~0.07
8V2	8.2	5	8.04~8.36	<7	<50	1	<0.1	<2	6.2	0.03~0.08
9V1	9.1	5	8.92~9.28	<10	<50	1	<0.1	<2	6.8	0.03~0.09
10	10	5	9.8~10.2	<15	<70	1	<0.1	<2	7.5	0.03~0.1
11	11	5	10.78~11.22	<20	<70	1	<0.1	<2	8.2	0.03~0.11
12	12	5	11.76~12.24	<20	<90	1	<0.1	<2	9.1	0.03~0.11
13	13	5	12.74~13.26	<26	<110	1	<0.1	<2	10	0.03~0.11
15	15	5	14.7~15.3	<30	<110	1	<0.1	<2	11	0.03~0.11
16	16	5	15.7~16.3	<40	<170	1	<0.1	<2	12	0.03~0.11
18	18	5	17.64~18.36	<50	<170	1	<0.1	<2	13	0.03~0.11
20	20	5	19.6~20.4	<55	<220	1	<0.1	<2	15	0.03~0.11
22	22	5	21.55~22.45	<55	<220	1	<0.1	<2	16	0.04~0.12
24	24	5	23.5~24.5	<80	<220	1	<0.1	<2	18	0.04~0.12
27	27	5	26.4~27.6	<80	<220	1	<0.1	<2	20	0.04~0.12
30	30	5	29.4~30.6	<80	<220	1	<0.1	<2	22	0.04~0.12
33	33	5	32.4~33.6	<80	<220	1	<0.1	<2	24	0.04~0.12
36	36	5	35.3~36.7	<80	<220	1	<0.1	<2	27	0.04~0.12
39	39	2.5	38.2~39.8	<90	<500	0.5	<0.1	<5	30	0.04~0.12
43	43	2.5	42.1~43.9	<90	<600	0.5	<0.1	<5	33	0.04~0.12
47	47	2.5	46.1~47.9	<110	<700	0.5	<0.1	<5	36	0.04~0.12
51	51	2.5	50~52	<125	<700	0.5	<0.1	<10	39	0.04~0.12
56	56	2.5	54.9~57.1	<135	<1000	0.5	<0.1	<10	43	0.04~0.12
62	62	2.5	60.8~63.2	<150	<1000	0.5	<0.1	<10	47	0.04~0.12
68	68	2.5	66.6~69.4	<200	<1000	0.5	<0.1	<10	51	0.04~0.12
75	75	2.5	73.5~76.5	<250	<1500	0.5	<0.1	<10	56	0.04~0.12

<sup>1)</sup> Other tolerances available request:

ZMM55C... ±5% of V<sub>Znom</sub>

<sup>2)</sup> at T<sub>J</sub>=150°C



Characteristics ( $T_j=25^\circ\text{C}$  unless otherwise specified)

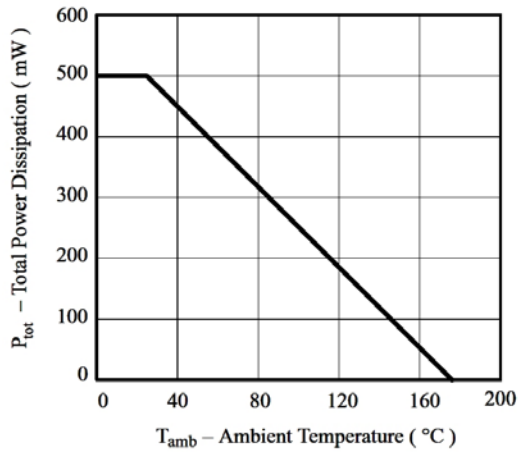

Figure 1. Total Power Dissipation vs. Ambient Temperature

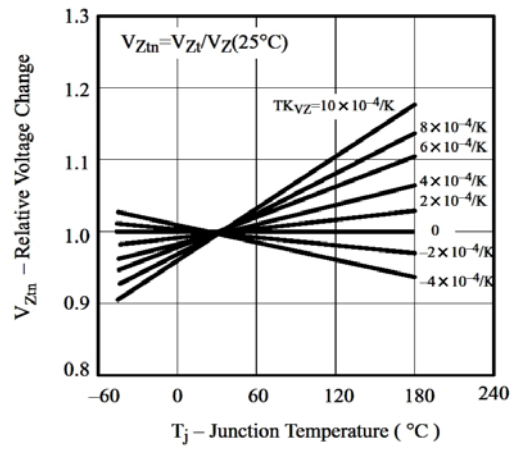

Figure 4. Typical Change of Working Voltage Vs. Junction Temperature

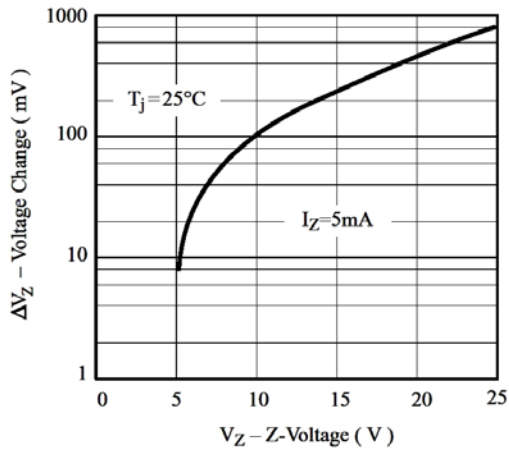

Figure 2. Typical Change of Working Voltage under Operating Conditions at  $T_{amb}=25^\circ\text{C}$

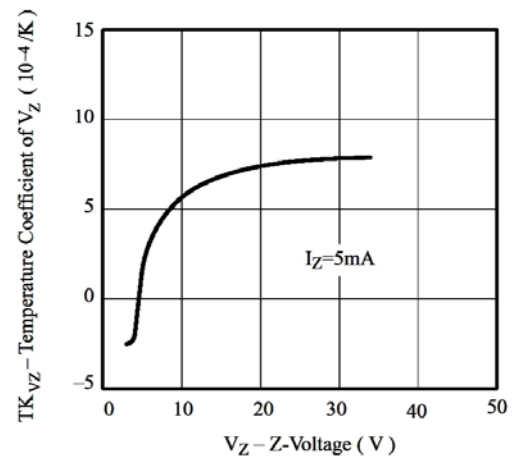

Figure 5. Temperature Coefficient of  $V_Z$  vs. Z-Voltage

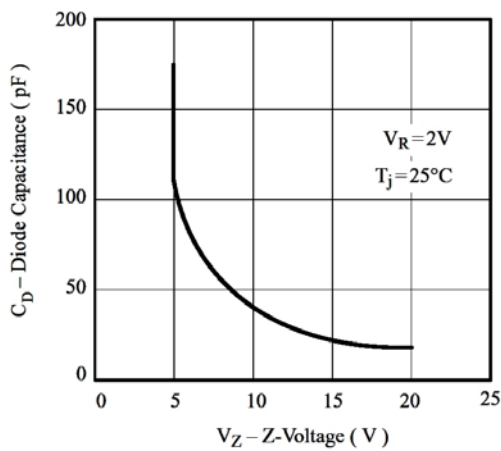

Figure 3. Diode Capacitance vs. Z-voltage

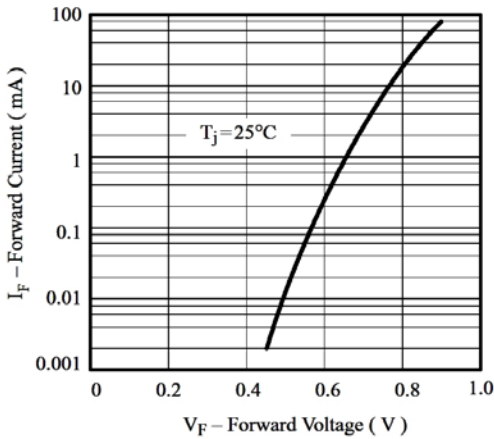

Figure 6. Forward Current vs. Forward Voltage

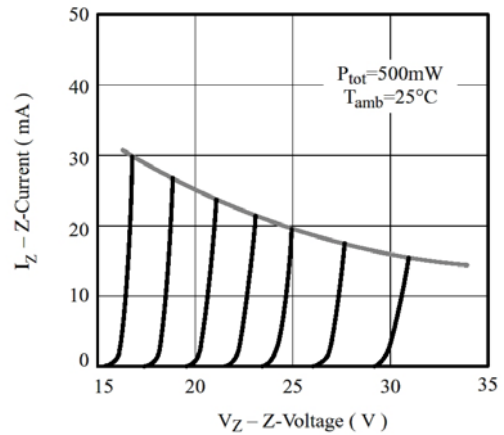

Figure 8. Z-Current vs. Z-Voltage

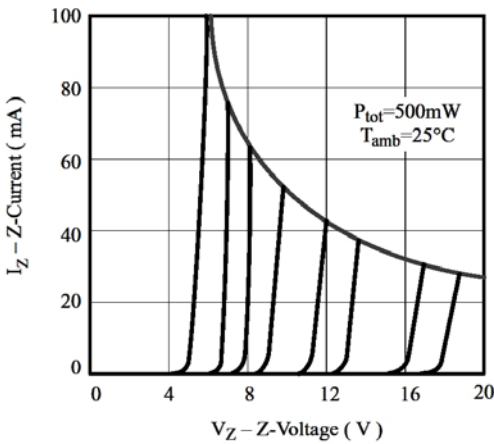

Figure 7. Z-Current vs. Z-Voltage

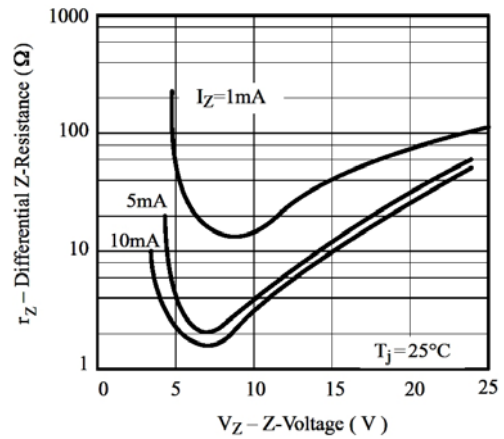

Figure 9. Differential Z-Resistance Vz vs. Z-Voltage

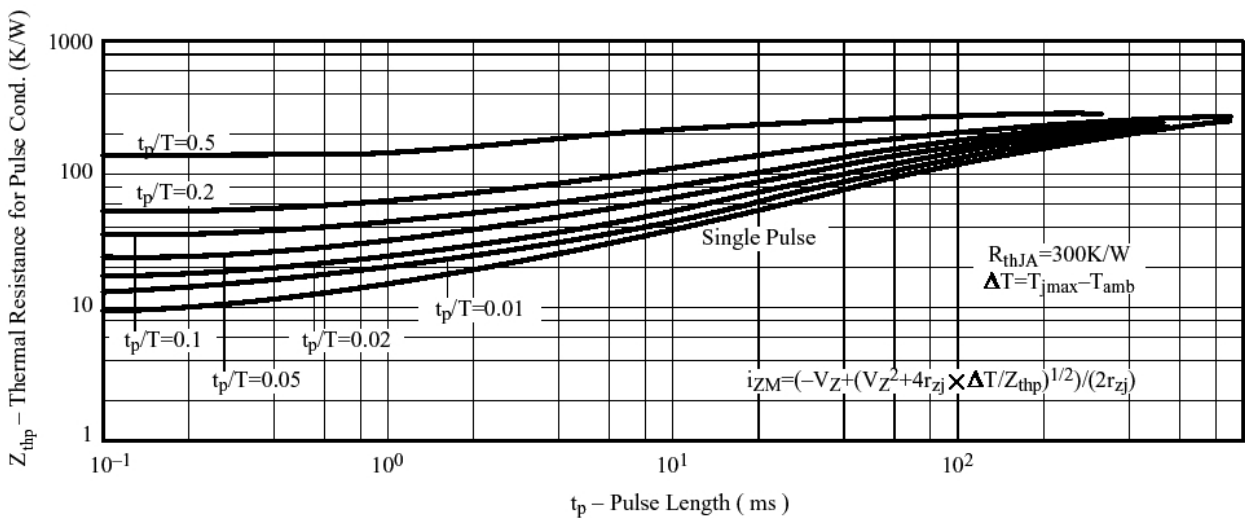
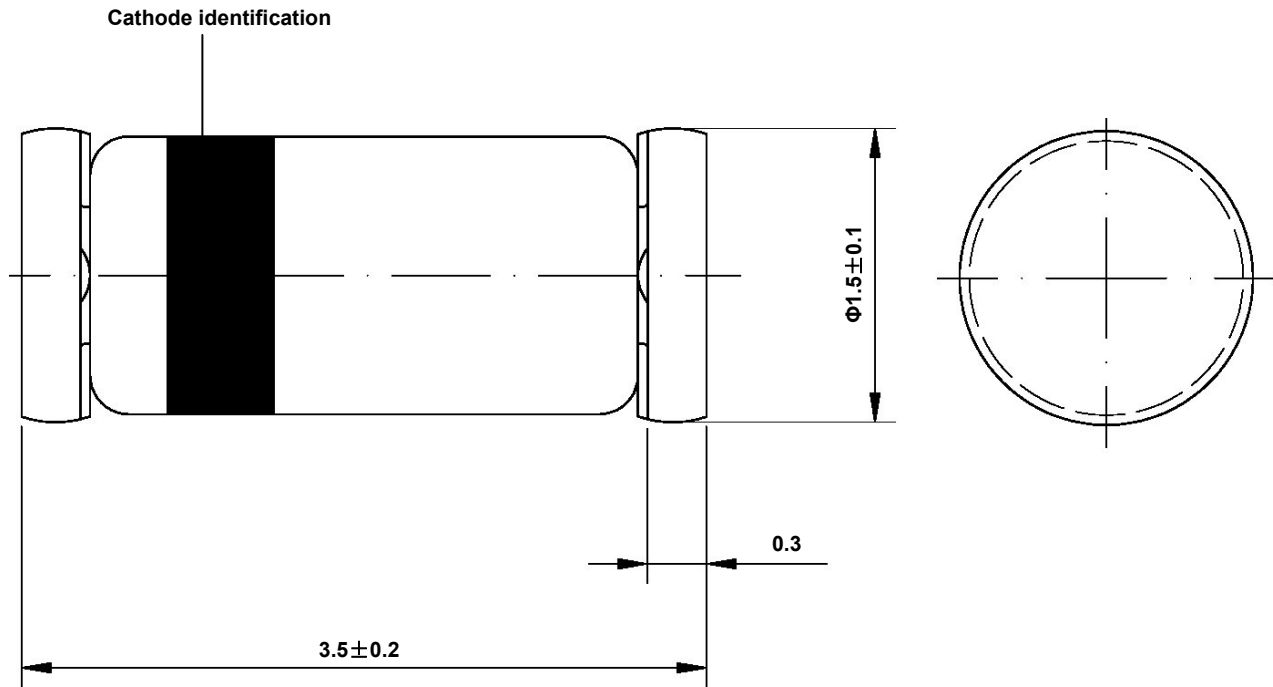

Figure 10. Thermal Response



**Dimensions in mm**



Glass Case  
Mini Melf / SOD-80  
JEDEC DO-213 AA