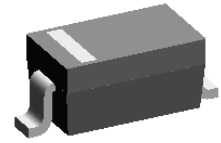
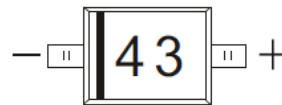

PRIMARY CHARACTERISTICS	
P_D	200mV
V_{RRM}	40V
I_F	200mA
$V_F@I_F=10mA$	500mV
$T_{STG Max}$	150°C

SOD-323 PACKAGE

Marking Code: 43

FEATURES

- LOW Turn-on Voltage
- Fast Switching
- PN Junction Guard for Transient and ESD Protection
- Designed for Surface Mount Application
- Moisture Sensitivity Level 1

MECHANICAL DATA

- Case : Molded plastic,SOD-323
- Polarity : Shown above
- Terminals :Plated terminals, solderable per MIL-STD-750,Method 2026
- Epoxy : UL94-V0 rated flame retardant

Maximum Ratings and Electrical Characteristics, Single Diode @ $T_A=25$

Parameter	Symbol	Limits	Unit
Peak Repetitive Peak reverse voltage	V_{RRM}	40	V
Working Peak Reverse Voltage	V_{RWM}		
DC Blocking Voltage	V_R		
Forward Continuous Current	I_F	200	mA
Peak forward surge current @<1.0s	I_{FSM}	600	mA
Power Dissipation	P_d	200	mW
Thermal Resistance Junction to Ambient	$R_{\theta JA}$	500	°C/W
Storage temperature	T_{STG}	-55 to +150	°C

NOTES:

Work in normal at 0 to 25°C

Work in decreasing the power at 25°C to 70°C

Above 70 °C isn't the temperature scope for civil use.

Electrical Ratings @ $T_A=25$ °C

Parameter	Symbol	Min.	Typ.	Max.	Unit	Conditions
Reverse Breakdown Voltage	$V_{(BR)R}$	40			V	$I_R=10\mu A$
Forward voltage	V_{F1}			0.38	V	$I_F=1mA$
	V_{F2}			0.5	V	$I_F=10mA$
	V_{F3}			1	V	$I_F=40mA$
Reverse current	I_R		20	200	nA	$V_R=30V$
Capacitance between terminals	C_T		4	5	pF	$V_R=0V,f=1MHz$
Reverse Recovery Time	t_{rr}			5	ns	$I_F=I_R=10mA$ $I_{rr}=0.1I_R,R_L=100\Omega$

Typical Characteristics

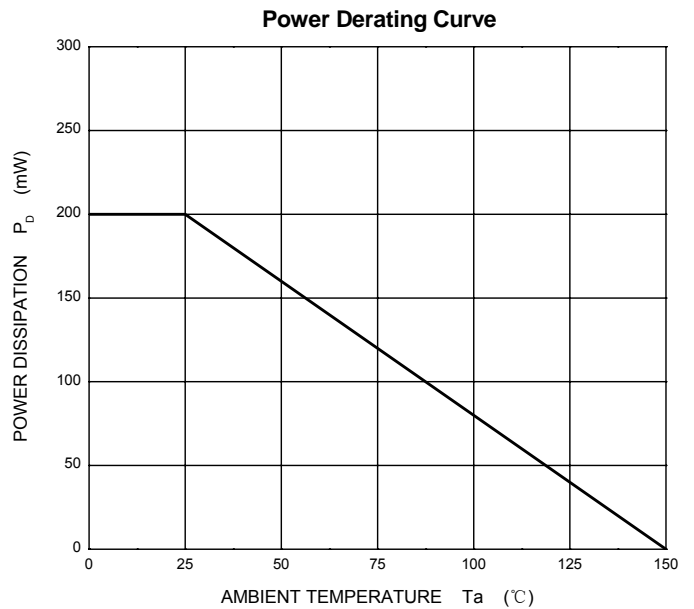
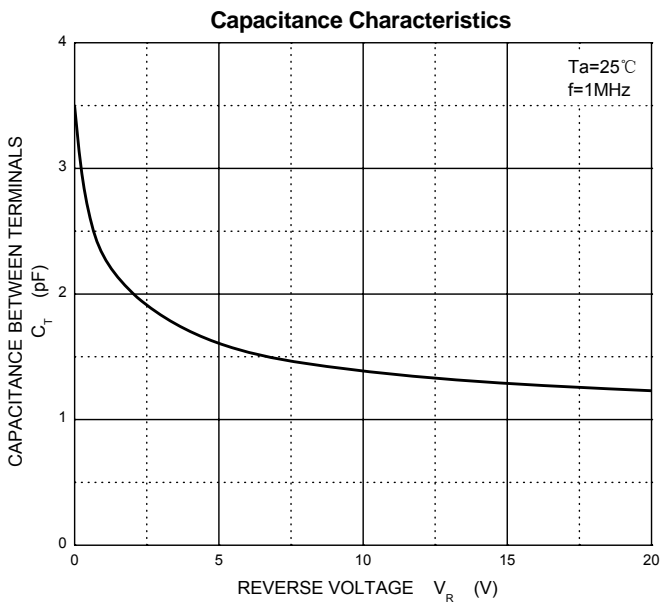
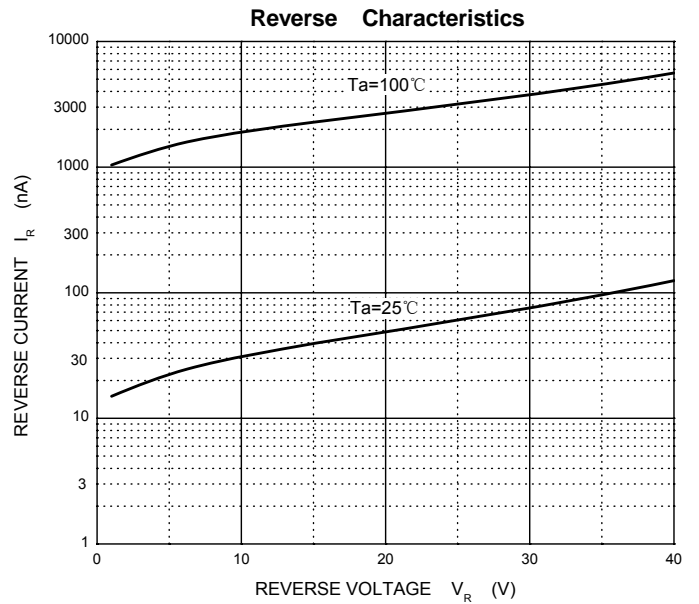
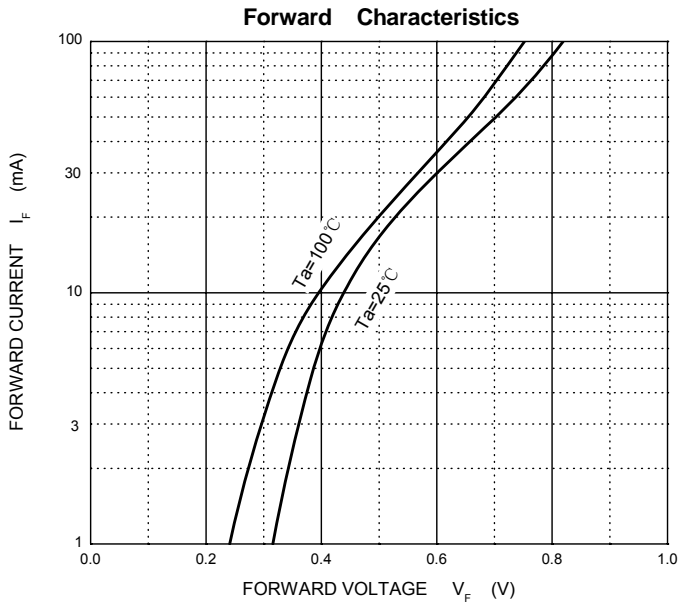

Outline Drawing

SOD-323

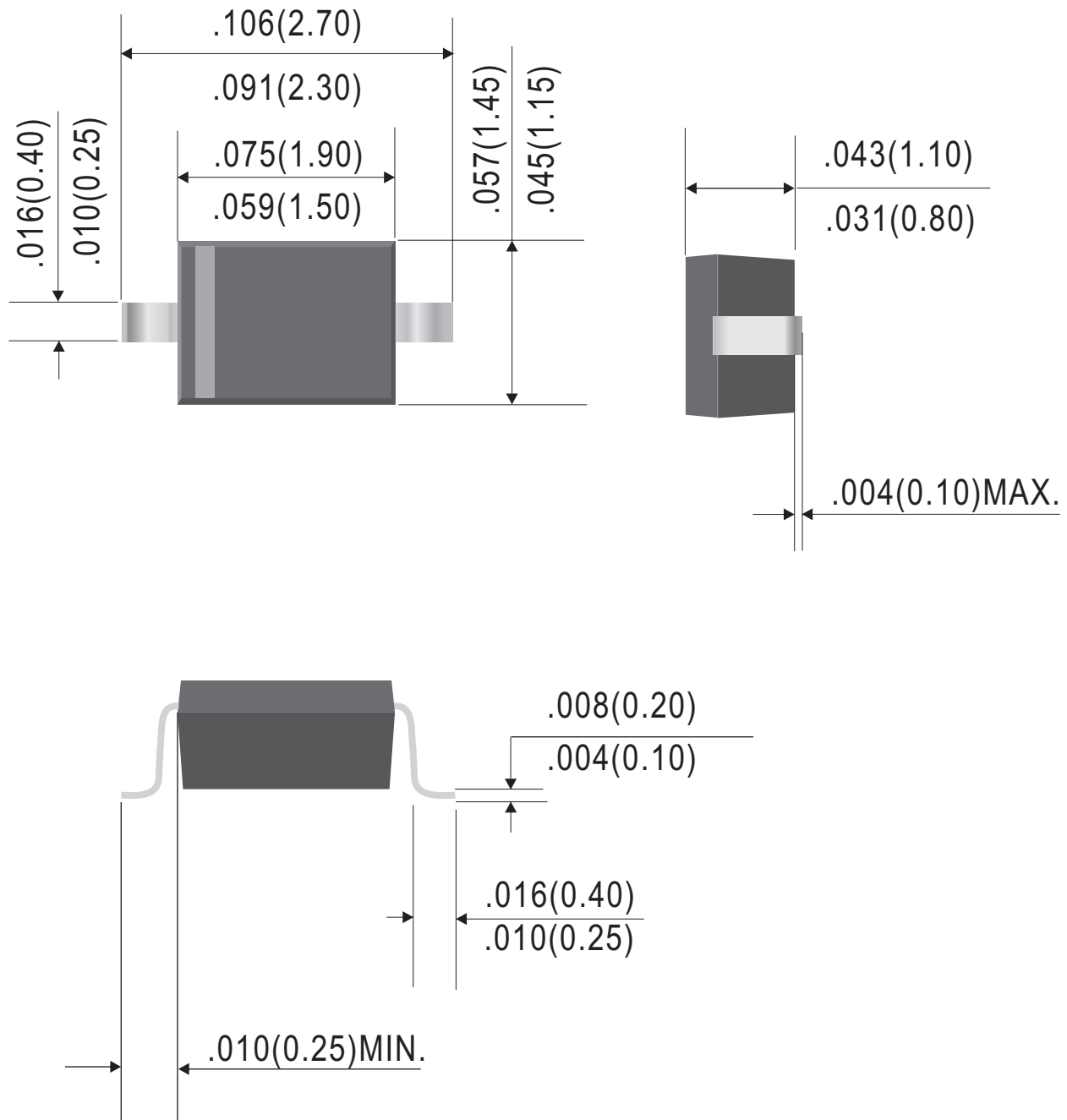

Dimensions in inches and (millimeters)

Rev.C

Suggested Soldering Pad Layout

SOD-323

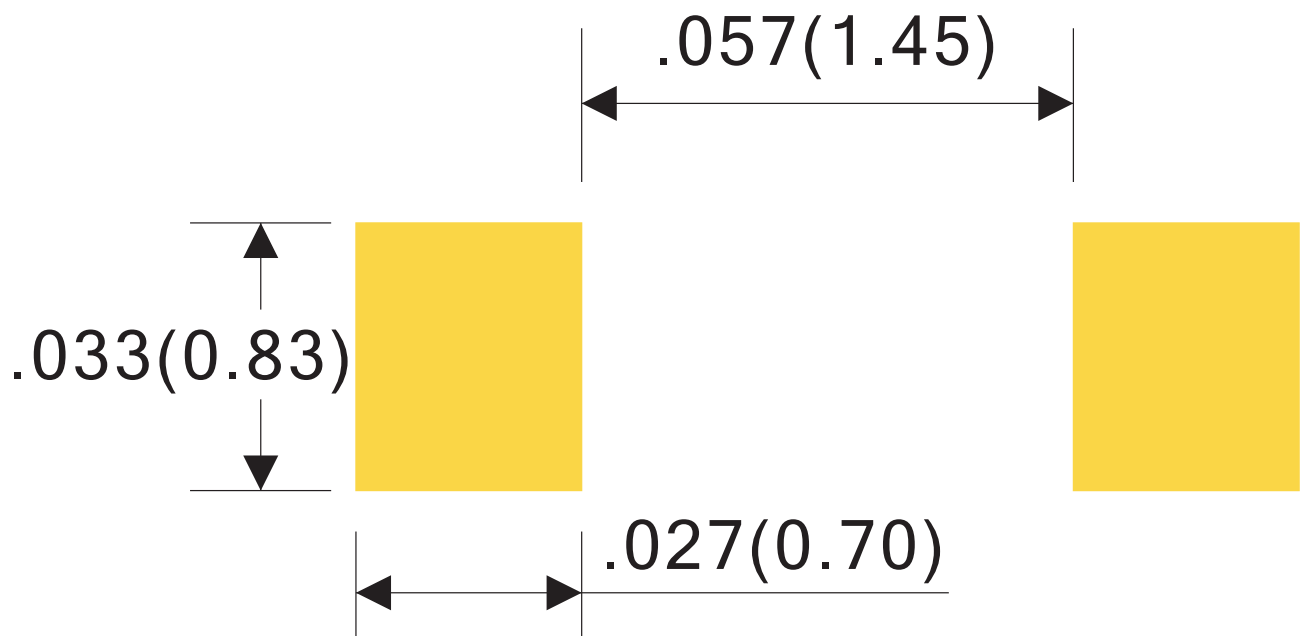

Dimensions in inches and (millimeters)

RevA

SOD-323 Tape and Reel

SOD-323 Embossed Carrier Tape

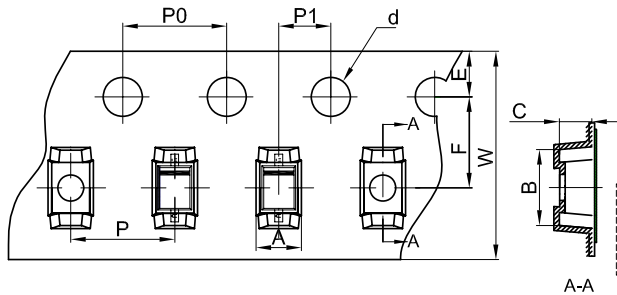

Packaging Description:

SOD-323 parts are shipped in tape. The carrier tape is made from a dissipative (carbon filled) polycarbonate resin. The cover tape is a multilayer film (Heat Activated Adhesive in nature) primarily composed of polyester film, adhesive layer, sealant, and anti-static sprayed agent. These reeled parts in standard option are shipped with 3,000 units per 7" or 17.8cm diameter reel. The reels are clear in color and is made of polystyrene plastic (anti-static coated).

Note: If it is the product of the same polarity, the cathode line should be removed.

Dimensions are in millimeter										
Pkg type	A	B	C	d	E	F	P0	P	P1	W
SOD-323	1.46	2.90	1.25	Ø1.50	1.75	3.50	4.00	4.00	2.00	8.00
(Tolerance)	+/-0.05	+/-0.05	+/-0.05	+/-0.1	+/-0.1	+/-0.1	+/-0.1	+/-0.1	+/-0.1	+0.3/-0.1

SOD-323 Tape Leader and Trailer

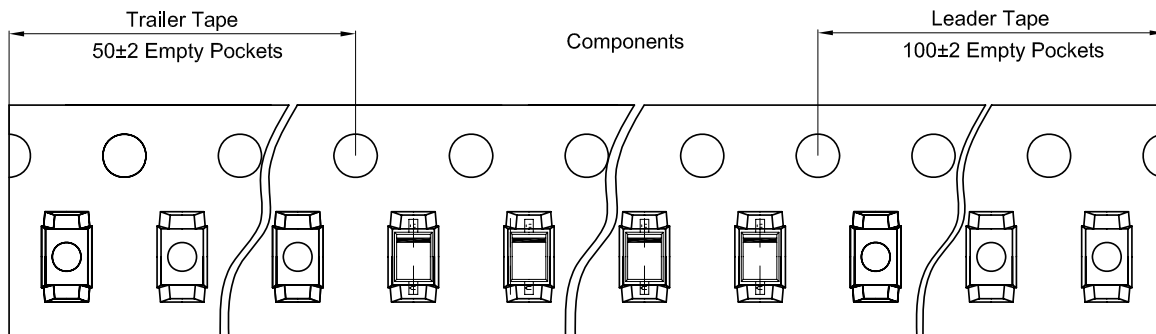

SOD-323 Reel

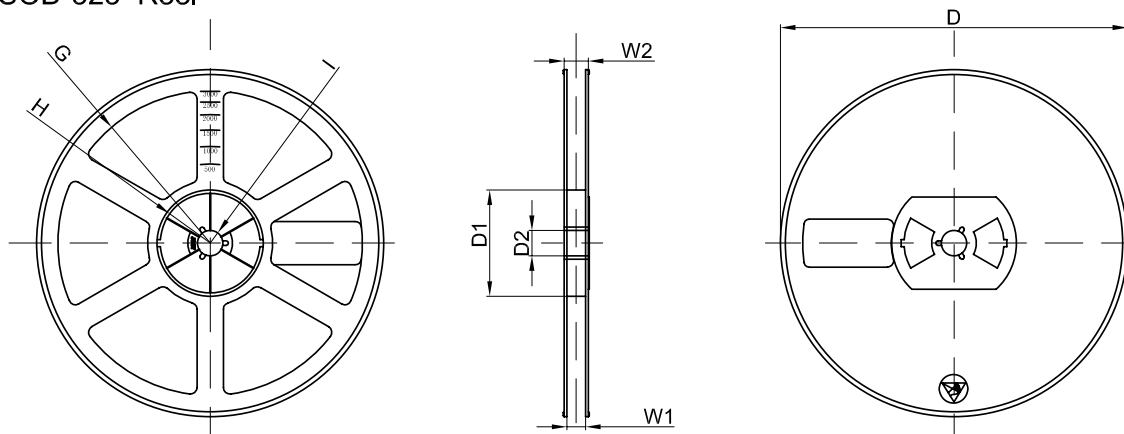

Dimensions are in millimeter								
Reel Option	D	D1	D2	G	H	I	W1	W2
7" Dia	Ø178.00	54.40	13.00	R78.00	R25.60	R6.50	9.50	12.30
Tolerance	+/-2	+/-1	+/-1	+/-1	+/-1	+/-1	+/-1	+/-1

REEL	Reel Size	Box	Box Size(mm)	Carton	Carton Size(mm)	G.W.(kg)
3000 pcs	7 inch	45,000 pcs	203×203×195	180,000 pcs	438×438×220	

Ordering Information:

Device PN	Packing
BAS40WS -T ⁽¹⁾ G ⁽²⁾ -WS	Tape&Reel: 3 Kpcs/Reel

Note: (1) Packing code, Tape & Reel Packing

(2) RoHS product for packing code suffix "G" ; Halogen free product for packing code suffix "H"

*****Disclaimer*****

WILLAS reserves the right to make changes without notice to any product specification herein, to make corrections, modifications, enhancements or other changes. WILLAS or anyone on its behalf assumes no responsibility or liability for any errors or inaccuracies. Data sheet specifications and its information contained are intended to provide a product description only. "Typical" parameters which may be included on WILLAS data sheets and/ or specifications can and do vary in different applications and actual performance may vary over time. WILLAS does not assume any liability arising out of the application or use of any product or circuit.

WILLAS products are not designed, intended or authorized for use in medical, life-saving implant or other applications intended for life-sustaining or other related applications where a failure or malfunction of component or circuitry may directly or indirectly cause injury or threaten a life without expressed written approval of WILLAS. Customers using or selling WILLAS components for use in such applications do so at their own risk and shall agree to fully indemnify WILLAS Inc and its subsidiaries harmless against all claims, damages and expenditures.