

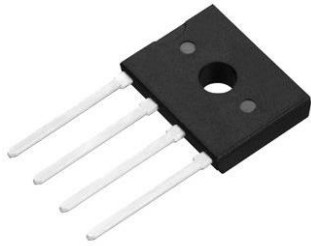

# UG3KBXX Series



## Glass Passivated Bridge Rectifier



**D3K**

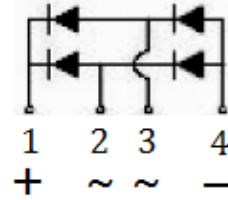

Features
<ul style="list-style-type: none"> <li>• Glass passivated die construction</li> <li>• Low forward voltage drop</li> <li>• High current capability</li> <li>• High surge current capability</li> <li>• Designed for surface mount application</li> <li>• Plastic material-UL flammability 94V-0</li> </ul>

Mechanical Data
<ul style="list-style-type: none"> <li>• Case: D3K, molded plastic</li> <li>• Terminals: plated leads solderable per MIL-STD-202, Method 208</li> <li>• Polarity: as marked on case</li> <li>• Mounting position: Any</li> <li>• Marking: type number</li> <li>• Lead Free: For RoHS / Lead Free Version,</li> </ul>

Ordering Information		
Part No.	Package	Packing
UG3KBXX Series	D3K	700/Box

Maximum Ratings and Electrical Characteristics (TA=25°C unless otherwise noted)									
Parameter	Symbol	UG3K B05	UG3K B10	UG3K B20	UG3K B40	UG3K B60	UG3K B80	UG3K B100	Units
Peak Repetitive Reverse Voltage	$V_{RRM}$	50	100	200	400	600	800	1000	V
Voltage Working Peak Reverse	$V_{RWM}$								
Voltage DC Blocking Voltage	$V_{DC}$								
RMS Reverse Voltage	$V_{RMS}$	35	70	140	280	420	560	700	V
Average Rectified Output Current	$I_O$	1.5							A
Without heat sink @ $T_A=30^\circ\text{C}$ With heat sink @ $T_A=140^\circ\text{C}$		3.0							
Non-Repetitive Peak Forward Surge Current 8.3ms Single half sine-wave superimposed on rated load (JEDEC Method)	$I_{FSM}$	80							A
Forward Voltage per element @ $I_F=3A$	$V_{FM}$	1.1							V
Maximum DC reverse current rated DC blocking voltage per leg @ $T_A=25^\circ\text{C}$ @ $T_A=125^\circ\text{C}$	$I_R$	5.0							uA
		500							
Typical Junction Capacitance per leg	$C_J$	21							pF
Typical Thermal Resistance per leg (Note 1)	$R_{\theta JA}$	55							°C/W
	$R_{\theta JL}$	15							
Operating and Storage Temperature Range	$T_J, T_{STG}$	-55~+150							°C
Marking		UG3K B05	UG3K B10	UG3K B20	UG3K B40	UG3K B60	UG3K B80	UG3K B100	

Note:  
1. Measured at 1.0 MHZ and applied reverse voltage of 4.0VD.C.



### Rating and Characteristics Curvers

Fig. 1 Output Current Derating Curve

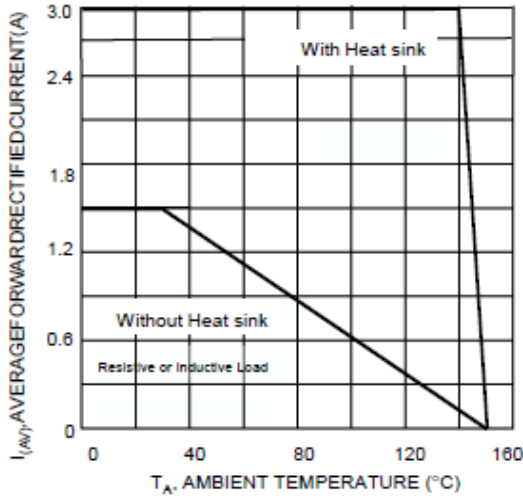

Fig. 2 Typical I Forward Characteristics (per leg)

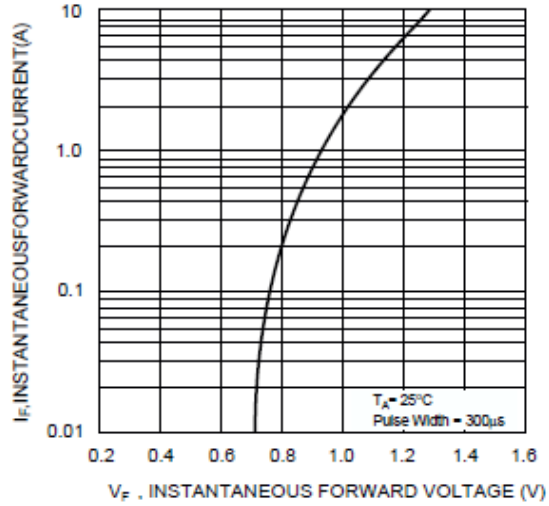

Fig. 3 Maximum Peak Forward Surge Current (per leg)

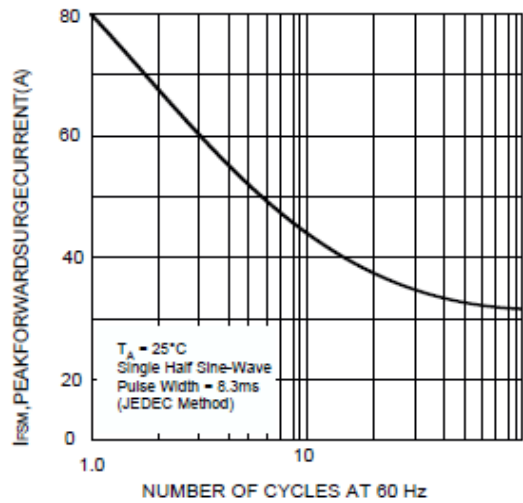

Fig.4 Typical Junction Capacitance Per Diode

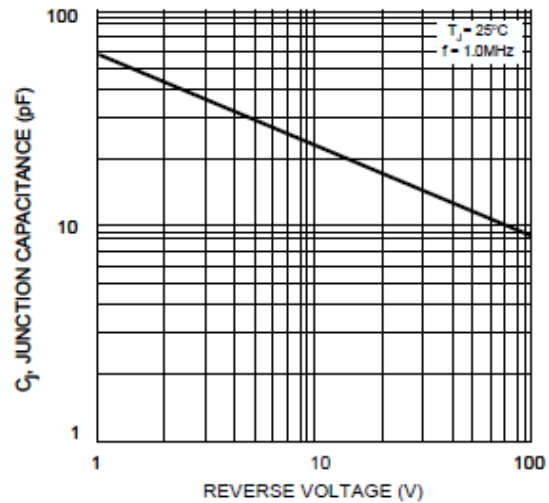
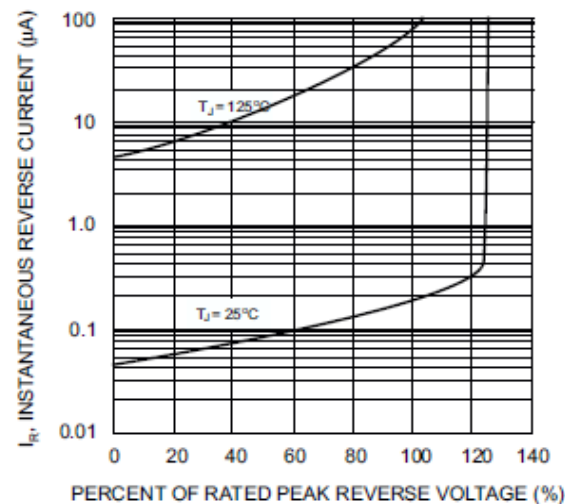
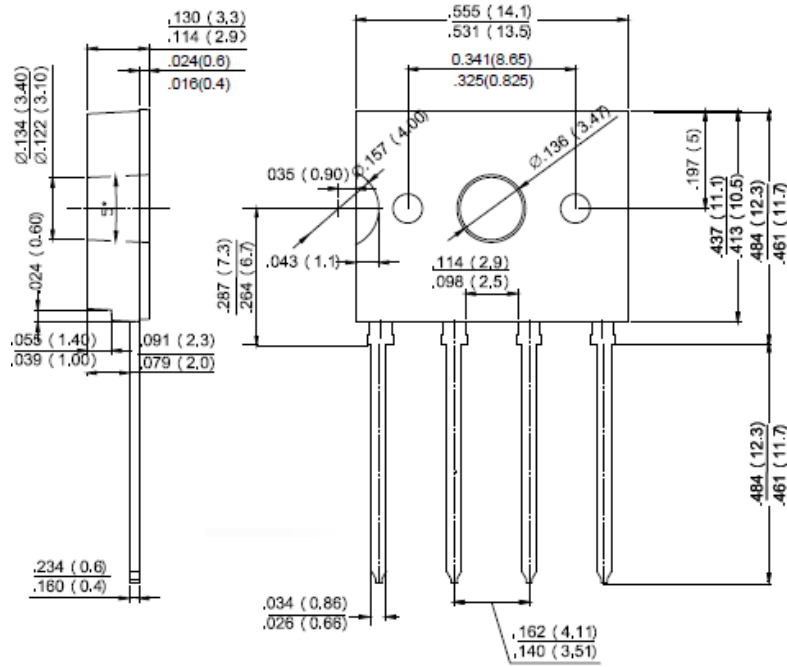

Fig. 5 Typical Reverse Characteristics (per element)





### Package Outline Dimensions



### D3K

Dimensions in inches and (millimeters)