

**UG3KB05 THRU UG3KB100**  
**Single-Phase 3.0A Glass Passivated Bridge Rectifier**

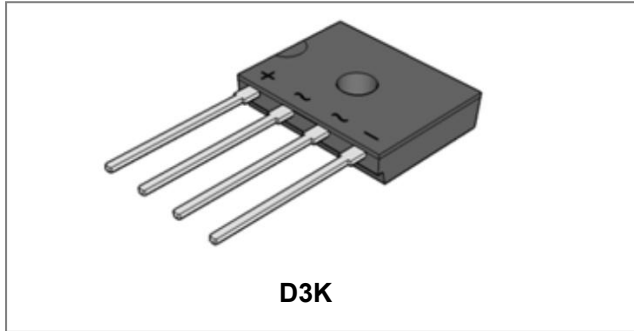

**Features**

- Glass passivated die construction
- Low forward voltage drop
- High current capability
- High surge current capability
- Designed for surface mount application
- Plastic material-UL flammability 94V-0
- This is a Pb – Free Device
- All SMC parts are traceable to the wafer lot
- Additional testing can be offered upon request

**Circuit Diagram**

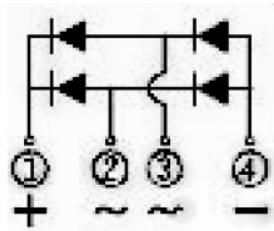

**Mechanical Data**

- Case: D3K, Molded plastic
- Terminals: Plated leads solderable per MIL-STD-202, Method 208
- Polarity: as marked on case
- Mounting Position: Any
- Lead Free: For RoHS / Lead Free Version

**Maximum Ratings: @T<sub>A</sub>=25°C unless otherwise specified**

Single Phase, half wave, 60Hz, resistive or inductive load. For capacitive load, derate current by 20%.

Type Number	Symbol	UG3K B05	UG3K B10	UG3K B20	UG3K B40	UG3K B60	UG3K B80	UG3K B100	Units
Peak Repetitive Reverse Voltage Working Peak Reverse Voltage DC Blocking Voltage	$V_{RRM}$ $V_{RWM}$ $V_{DC}$	50	100	200	400	600	800	1000	V
RMS Reverse Voltage	$V_{RMS}$	35	70	140	280	420	560	700	V
Average Rectified Output Current Without heat sink @T <sub>A</sub> = 30°C With heat sink @T <sub>A</sub> = 140°C	$I_O$	1.5 3.0							A
Non-Repetitive Peak Forward Surge Current 8.3ms Single half sine-wave superimposed on rated load (JEDEC Method)	$I_{FSM}$	80							A

**Electrical Characteristics:**

Type Number	Symbol	UG3K B05	UG3K B10	UG3K B20	UG3K B40	UG3K B60	UG3K B80	UG3K B100	Units	
Forward Voltage (per element) * @ $I_F = 3.0A$	$V_F$					1.1				V
Peak Reverse Current * @ $T_A = 25^\circ C$ At Rated DC Blocking Voltage * @ $T_A = 125^\circ C$	$I_R$					5.0				$\mu A$
Typical Junction Capacitance(per leg) (Note 1)	$C_J$					21				pF

\* Pulse width < 300  $\mu s$ , duty cycle < 2%

**Thermal-Mechanical Specifications:**

Type Number	Symbol	UG3K B05	UG3K B10	UG3K B20	UG3K B40	UG3K B60	UG3K B80	UG3K B100	Units	
Typical Thermal Resistance (per leg)	$R_{\theta JA}$ $R_{\theta JL}$					55				$^\circ C/W$
Operating and Storage Temperature Range	$T_J, T_{STG}$					-55 to +150				$^\circ C$

Note: 1. Measured at 1.0 MHz and applied reverse voltage of 4.0V D.C.

**Ratings and Characteristics Curves**

Fig. 1 Output Current Derating Curve

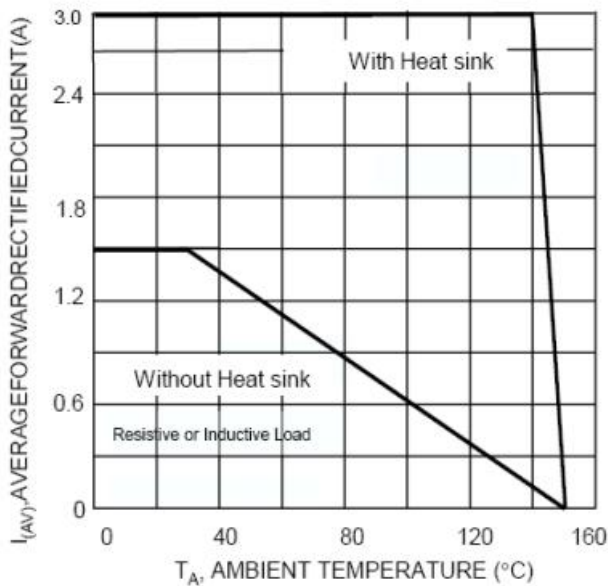

Fig. 2 Typical I Forward Characteristics (per leg)

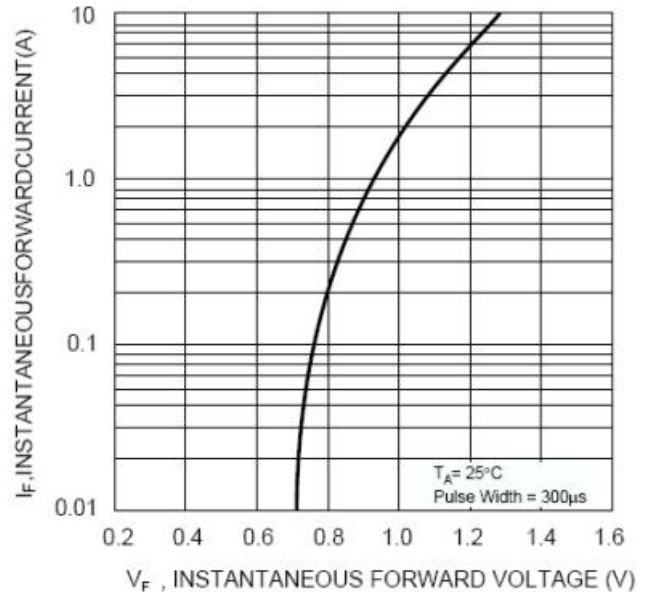

Fig. 3 Maximum Peak Forward Surge Current (per leg)

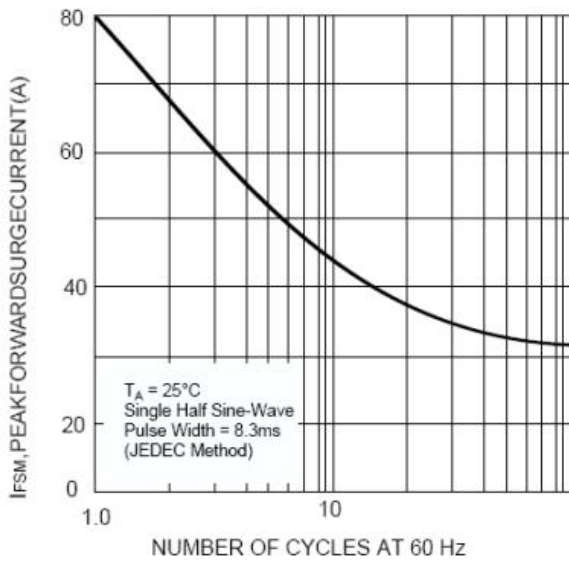

Fig.4 Typical Junction Capacitance Per Diode

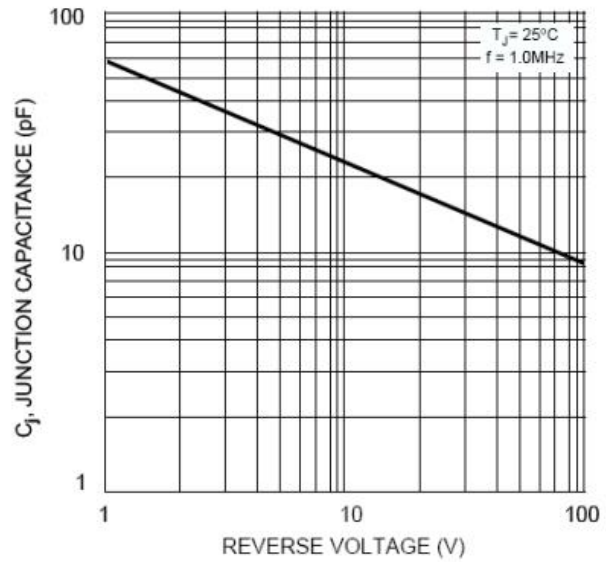
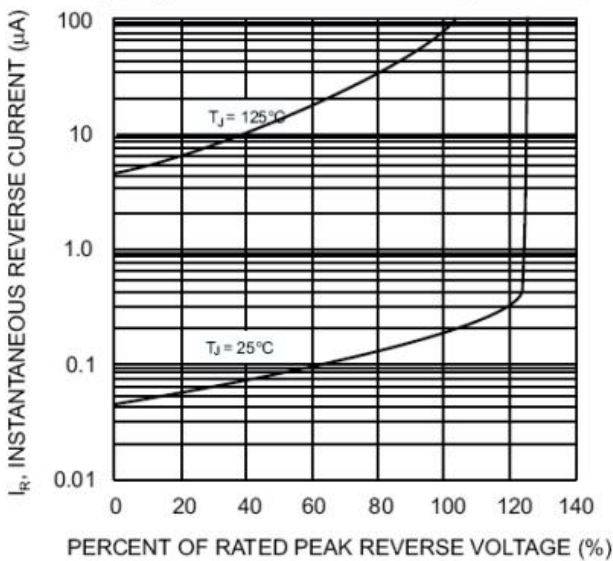

Fig. 5 Typical Reverse Characteristics (per element)



**Ordering Information**

Device	Package	Plating	Shipping
UG3KB05 THRU UG3KB100	D3K(Pb-Free)	Pure Sn	37pcs / tube

For information on tape and reel specifications, including part orientation and tape sizes, please refer to our tape and reel packaging specification.

**Marking Diagram**

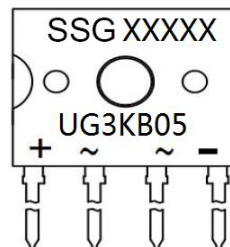

Where XXXXX is YYWWL

SSG = SSG  
YY = Year  
WW = Week  
L = Lot Number  
UG3KB05 = Type Number

**Cautions:** Molding resin  
Epoxy resin UL:94V-0

**Mechanical Dimensions D3K (Inches/Millimeters)**

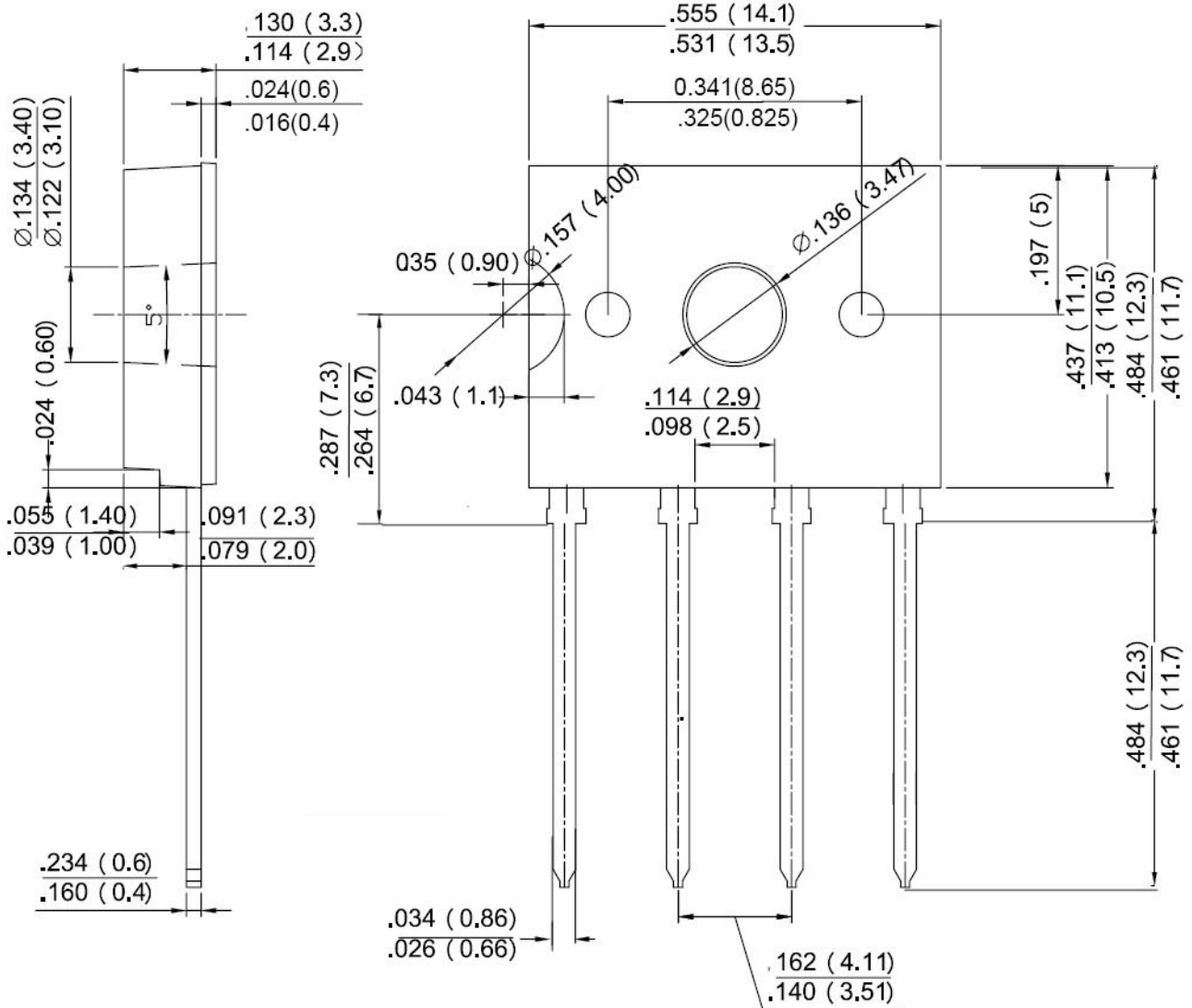

**DISCLAIMER:**

- 1- The information given herein, including the specifications and dimensions, is subject to change without prior notice to improve product characteristics. Before ordering, purchasers are advised to contact the SMC Diode Solutions sales department for the latest version of the datasheet(s).
- 2- In cases where extremely high reliability is required (such as use in nuclear power control, aerospace and aviation, traffic equipment, medical equipment, and safety equipment), safety should be ensured by using semiconductor devices that feature assured safety or by means of users' fail-safe precautions or other arrangement.
- 3- In no event shall SMC Diode Solutions be liable for any damages that may result from an accident or any other cause during operation of the user's units according to the datasheet(s). SMC Diode Solution assumes no responsibility for any intellectual property claims or any other problems that may result from applications of information, products or circuits described in the datasheets.
- 4- In no event shall SMC Diode Solutions be liable for any failure in a semiconductor device or any secondary damage resulting from use at a value exceeding the absolute maximum rating.
- 5- No license is granted by the datasheet(s) under any patents or other rights of any third party or SMC Diode Solutions.
- 6- The datasheet(s) may not be reproduced or duplicated, in any form, in whole or part, without the expressed written permission of SMC Diode Solutions.
- 7- The products (technologies) described in the datasheet(s) are not to be provided to any party whose purpose in their application will hinder maintenance of international peace and safety nor are they to be applied to that purpose by their direct purchasers or any third party. When exporting these products (technologies), the necessary procedures are to be taken in accordance with related laws and regulations.