

RoHS Compliant Product
 A Suffix of "-C" specifies halogen & lead-free

DESCRIPTIONS

The SSI2085E-C is the highest performance trench N-Ch and P-Ch MOSFETs with extreme high cell density, which provide excellent $R_{DS(ON)}$ and gate charge for most of the synchronous buck converter applications.

The SSI2085E-C meet the RoHS and Green Product requirement with full function reliability approved.

FEATURES

- Advanced High Cell Density Trench Technology
- Super Low Gate Charge
- Green Device Available

PACKAGE INFORMATION

Package	MPQ	Leader Size
SOT-563	3K	7 inch

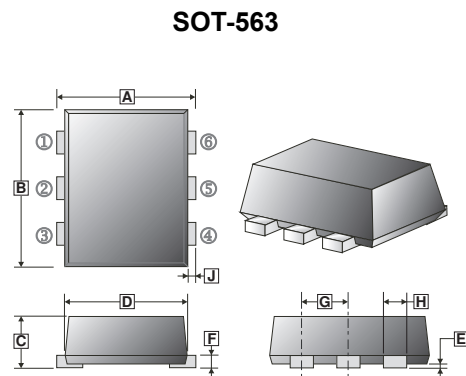

REF.	Millimeter		REF.	Millimeter	
	Min.	Max.		Min.	Max.
A	1.50	1.70	F	0.09	0.16
B	1.50	1.70	G	0.45	0.55
C	0.525	0.60	H	0.17	0.27
D	1.10	1.30	J	0.10	0.30
E	-	0.05			

ORDER INFORMATION

Part Number	Type
SSI2085E-C	Lead (Pb)-free and Halogen-free

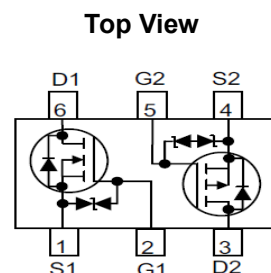

MAXIMUM RATINGS ($T_A=25^\circ\text{C}$ unless otherwise specified)

Parameter	Symbol	Ratings		Unit
		N-Channel	P-Channel	
Drain-Source Voltage	V_{DS}	20	-20	V
Gate-Source Voltage	V_{GS}	± 12		V
Continuous Drain Current ¹ $V_{GS}@4.5V$	$T_A=25^\circ\text{C}$	0.56	-0.5	A
	$T_A=85^\circ\text{C}$	0.4	-0.35	
Pulsed Drain Current ³	I_{DM}	1.68	-1.5	A
Power Dissipation	$T_A=25^\circ\text{C}$	280		mW
Operating Junction & Storage Temperature Range	T_J, T_{STG}	-55~150		$^\circ\text{C}$
Thermal Resistance Ratings				
Thermal Resistance Junction-Ambient ¹	$R_{\theta JA}$	450		$^\circ\text{C/W}$
Thermal Resistance Junction-Ambient ²		833		
Thermal Resistance Junction-Case ¹	$R_{\theta JC}$	320		

N-Ch ELECTRICAL CHARACTERISTICS ($T_J=25^\circ\text{C}$ unless otherwise specified)

Parameter	Symbol	Min.	Typ.	Max.	Unit	Test Conditions	
Drain-Source Breakdown Voltage	BV_{DSS}	20	-	-	V	$V_{GS}=0, I_D=250\mu\text{A}$	
Gate Threshold Voltage	$V_{GS(th)}$	0.45	-	1.2	V	$V_{DS}=V_{GS}, I_D=250\mu\text{A}$	
Gate- Source Leakage Current	I_{GSS}	-	-	± 10	μA	$V_{GS}= \pm 12\text{V}$	
Drain-Source Leakage Current	I_{DSS}	$T_J=25^\circ\text{C}$	-	-	1	μA	$V_{DS}=16\text{V}, V_{GS}=0$
		$T_J=70^\circ\text{C}$	-	-	10		
Static Drain-Source On-Resistance ⁴	$R_{DS(ON)}$	-	-	450	m Ω	$V_{GS}=4.5\text{V}, I_D=500\text{mA}$	
		-	-	700		$V_{GS}=2.5\text{V}, I_D=400\text{mA}$	
		-	-	1200		$V_{GS}=1.8\text{V}, I_D=350\text{mA}$	
Forward Transconductance	g_{fs}	-	1	-	S	$V_{DS}=10\text{V}, I_D=400\text{mA}$	
Total Gate Charge	Q_g	-	0.76	-	nC	$I_D=250\text{mA}$ $V_{DS}=10\text{V}$ $V_{GS}=4.5\text{V}$	
Gate-Source Charge	Q_{gs}	-	0.074	-			
Gate-Drain Charge	Q_{gd}	-	0.27	-			
Turn-on Delay Time	$T_{d(on)}$	-	5	-	nS	$V_{DS}=10\text{V}$ $I_D=200\text{mA}$ $V_{GS}=4.5\text{V}$ $R_G=10\Omega$	
Rise Time	T_r	-	5	-			
Turn-off Delay Time	$T_{d(off)}$	-	24	-			
Fall Time	T_f	-	18	-			
Input Capacitance	C_{iss}	-	60	-	pF	$V_{GS}=0$ $V_{DS}=10\text{V}$ $f=1\text{MHz}$	
Output Capacitance	C_{oss}	-	14	-			
Reverse Transfer Capacitance	C_{rss}	-	9	-			
Source-Drain Diode							
Continuous Source Current ¹	I_S	-	-	0.56	A		
Pulsed Source Current ³	I_{SM}	-	-	1.68			
Forward On Voltage ⁴	V_{SD}	-	-	1.2	V	$I_S=150\text{mA}, V_{GS}=0$	

P-Ch ELECTRICAL CHARACTERISTICS (T_J=25°C unless otherwise specified)

Parameter	Symbol	Min.	Typ.	Max.	Unit	Test Conditions	
Drain-Source Breakdown Voltage	BV _{DSS}	-20	-	-	V	V _{GS} =0, I _D = -250μA	
Gate Threshold Voltage	V _{GS(th)}	-0.45	-	-1.2	V	V _{DS} =V _{GS} , I _D = -250μA	
Gate- Source Leakage Current	I _{GSS}	-	-	±10	μA	V _{GS} = ±12V	
Drain-Source Leakage Current	I _{DSS}	T _J =25°C	-	-	-1	μA	V _{DS} = -16V, V _{GS} =0
		T _J =70°C	-	-	-10		
Static Drain-Source On-Resistance ⁴	R _{DS(ON)}	-	-	900	mΩ	V _{GS} = -4.5V, I _D = -500mA	
		-	-	1400		V _{GS} = -2.5V, I _D = -300mA	
		-	-	2700		V _{GS} = -1.8V, I _D = -150mA	
Forward Transconductance	g _{fs}	-	0.7	-	S	V _{DS} = -10V, I _D = -250mA	
Total Gate Charge	Q _g	-	1.5	-	nC	I _D = -250mA V _{DS} = -10V V _{GS} = -4.5V	
Gate-Source Charge	Q _{gs}	-	0.28	-			
Gate-Drain Charge	Q _{gd}	-	0.44	-			
Turn-on Delay Time	T _{d(on)}	-	5	-	nS	V _{DS} = -10V I _D = -200mA V _{GS} = -4.5V R _G =10Ω	
Rise Time	T _r	-	6	-			
Turn-off Delay Time	T _{d(off)}	-	42	-			
Fall Time	T _f	-	14	-			
Input Capacitance	C _{iss}	-	59	-	pF	V _{GS} =0 V _{DS} = -10V f=1MHz	
Output Capacitance	C _{oss}	-	21	-			
Reverse Transfer Capacitance	C _{rss}	-	15	-			
Source-Drain Diode							
Continuous Source Current ¹	I _S	-	-	-0.5	A		
Pulsed Source Current ³	I _{SM}	-	-	-1.5			
Forward On Voltage ⁴	V _{SD}	-	-	-1.2	V	I _S = -150mA, V _{GS} =0	

Notes:

- Surface mounted on a 1 inch² FR-4 board with 2oz copper.
- When mounted on Min. copper pad.
- Pulse width limited by maximum junction temperature, pulse width ≤ 10μs, duty cycle ≤ 2%.
- The data tested by pulsed, pulse width ≤ 300μs, duty cycle ≤ 2%.

N-Ch CHARACTERISTIC CURVES

Typical Output Characteristics

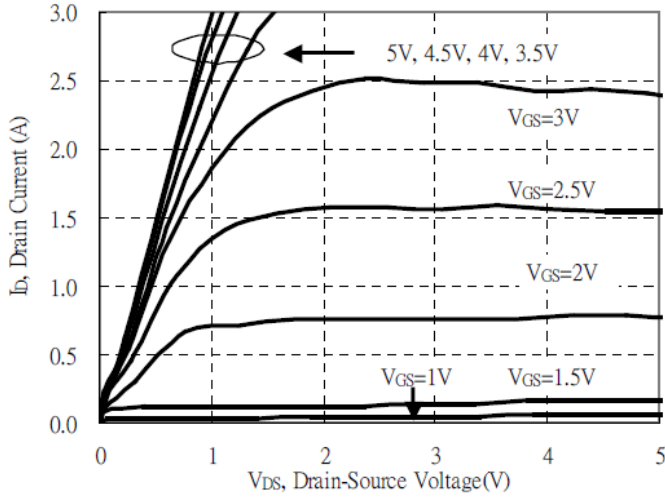

Typical Transfer Characteristics

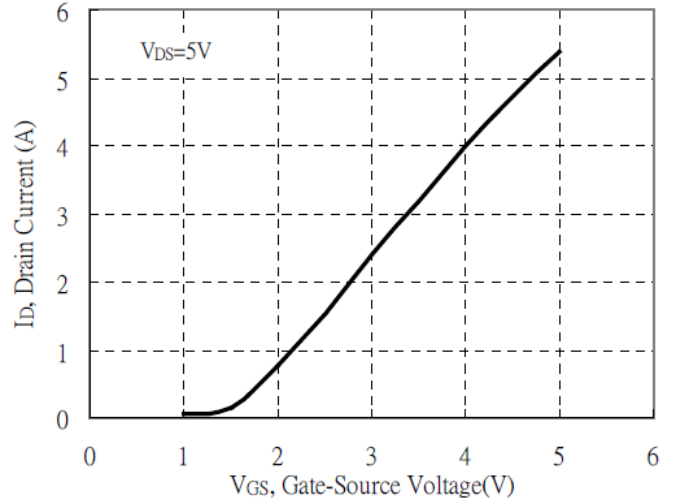

Static Drain-Source On-State resistance vs Drain Current

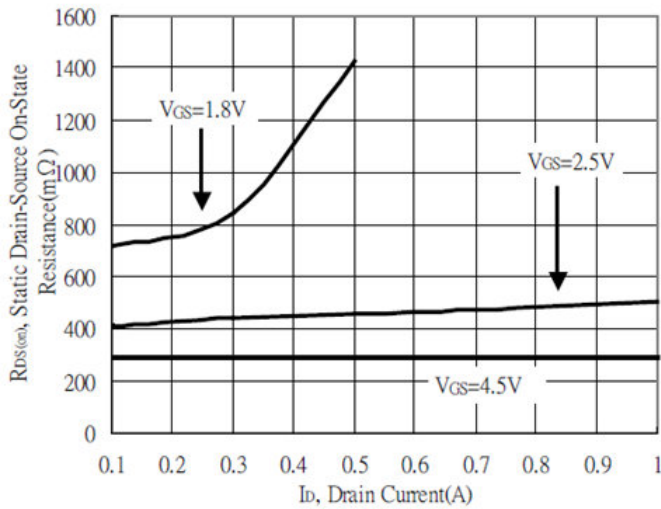

Reverse Drain Current vs Source-Drain Voltage

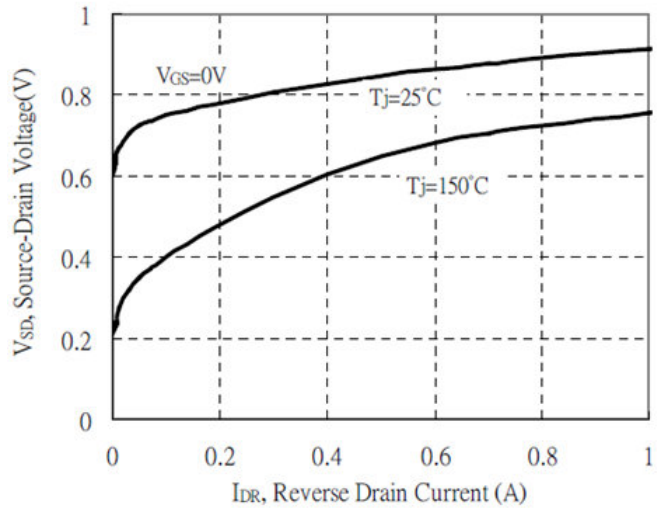

Static Drain-Source On-State Resistance vs Gate-Source Voltage

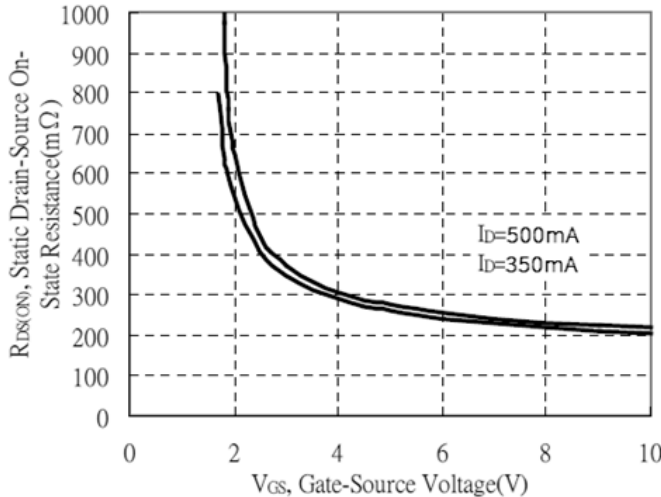

Drain-Source On-State Resistance vs Junction Temperature

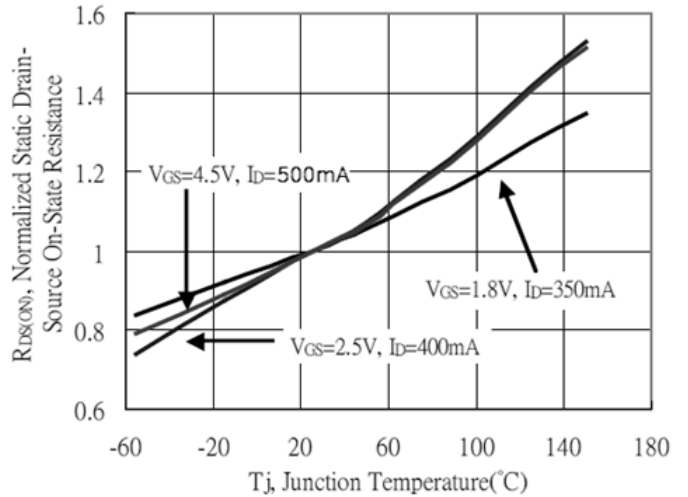

N-Ch CHARACTERISTIC CURVES

Capacitance vs Drain-to-Source Voltage

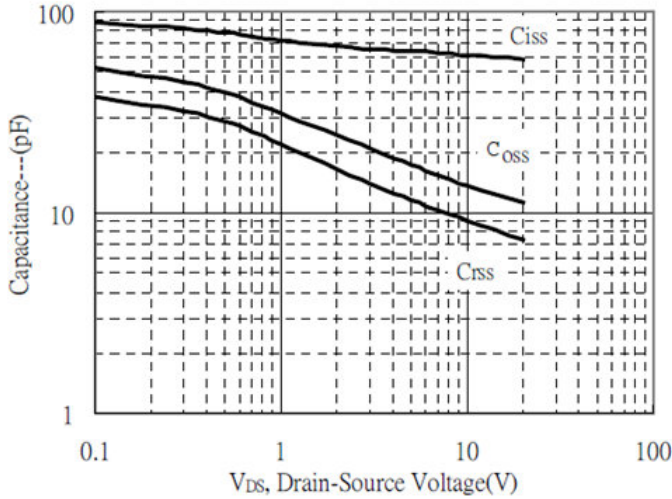

Threshold Voltage vs Junction Temperature

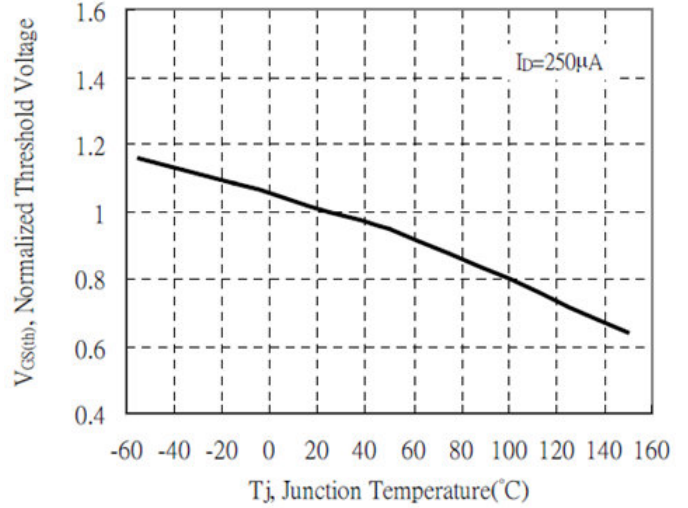

Maximum Safe Operating Area

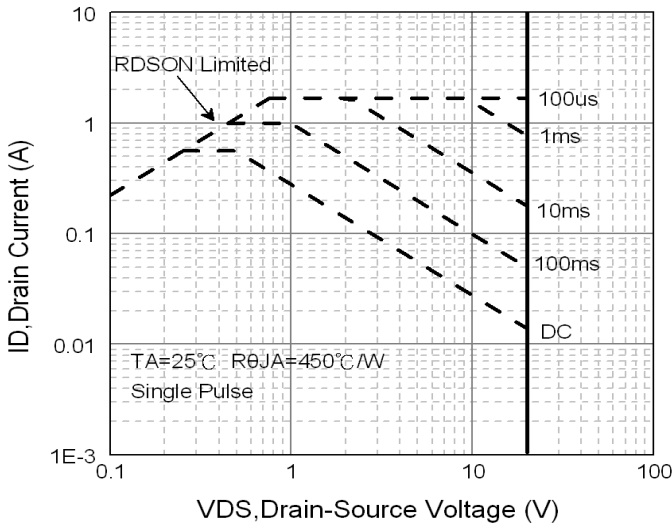

Gate Charge Characteristics

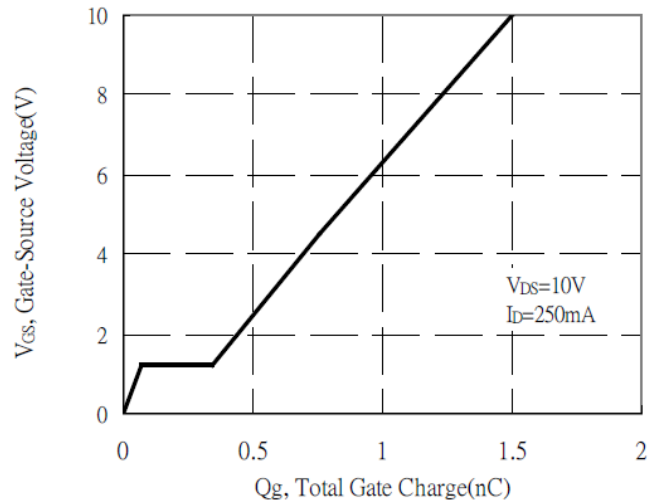

Transient Thermal Response Curves

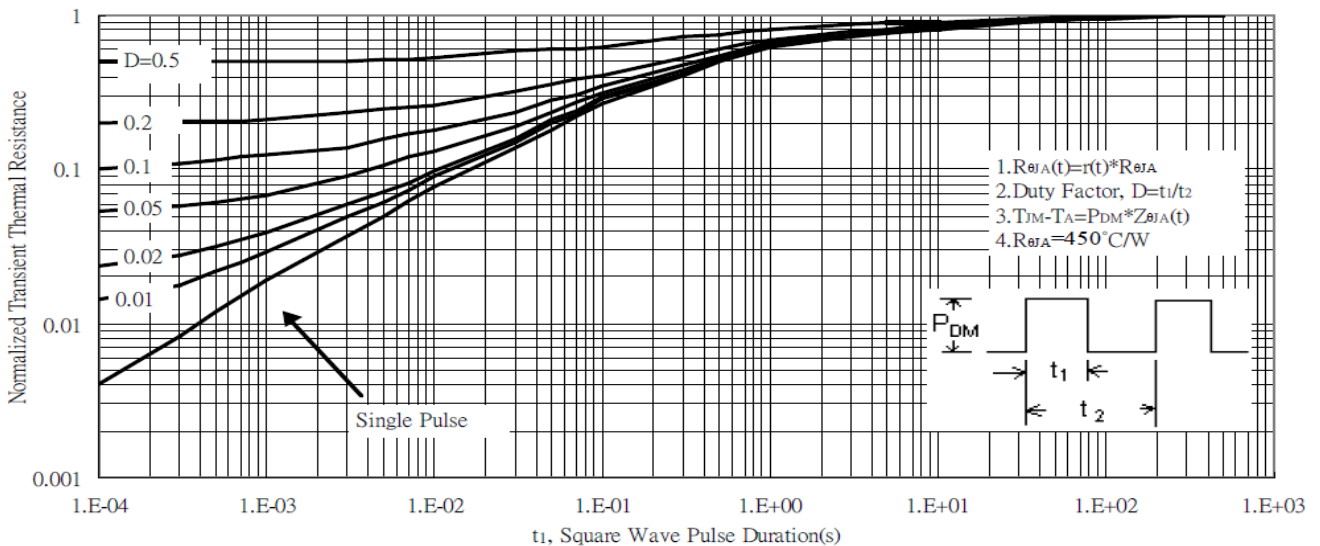

P-Ch CHARACTERISTIC CURVES

Typical Output Characteristics

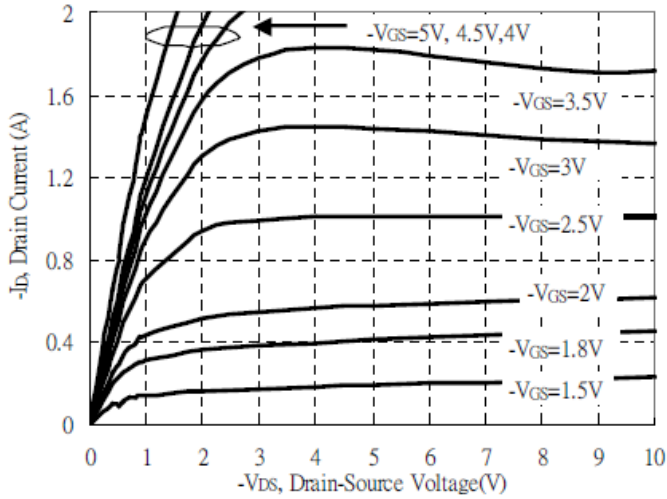

Typical Transfer Characteristics

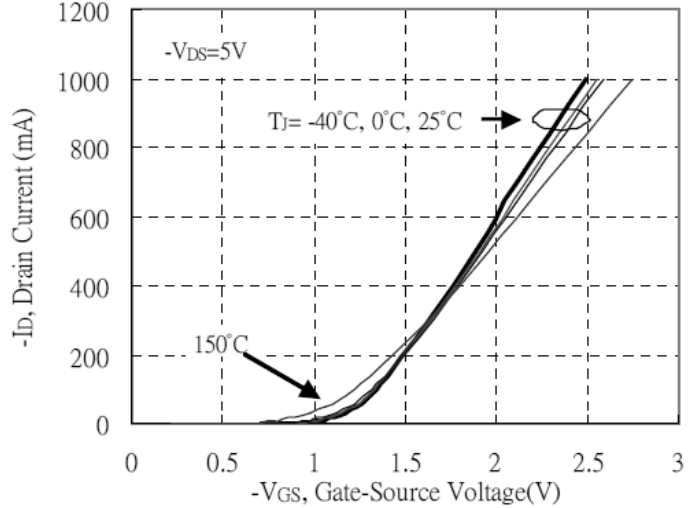

Static Drain-Source On-State resistance vs Drain Current

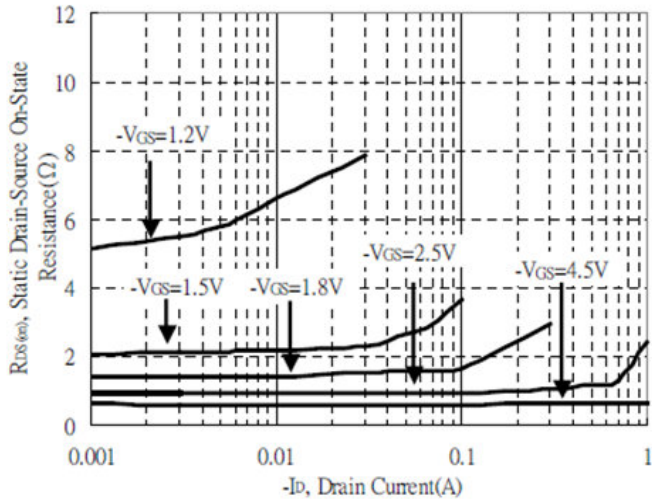

Reverse Drain Current vs Source-Drain Voltage

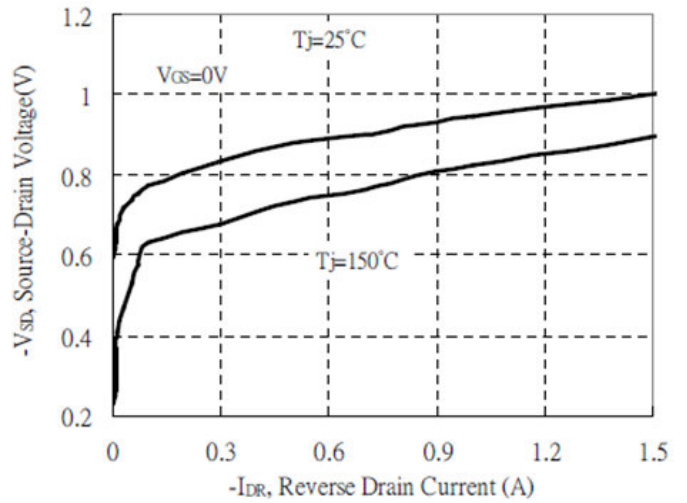

Static Drain-Source On-State Resistance vs Gate-Source Voltage

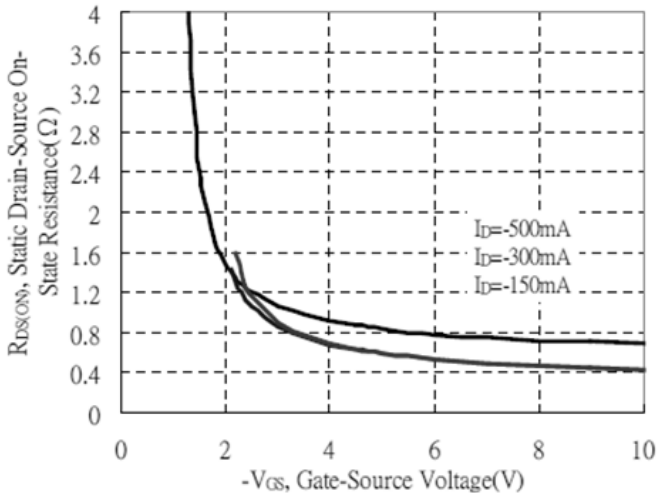

Drain-Source On-State Resistance vs Junction Temperature

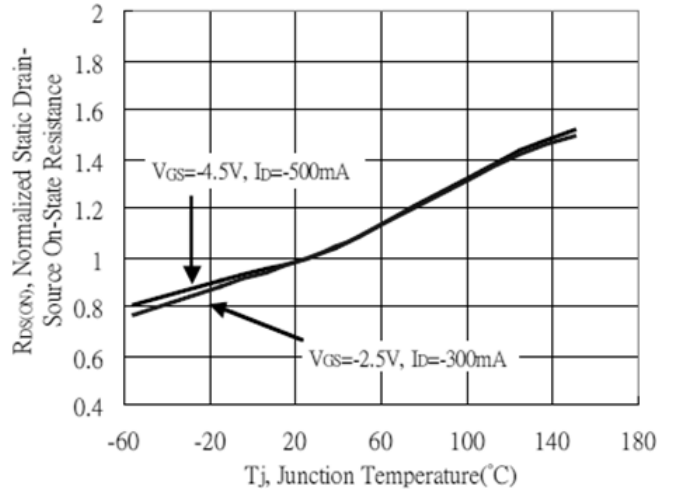

P-Ch CHARACTERISTIC CURVES

Capacitance vs Drain-to-Source Voltage

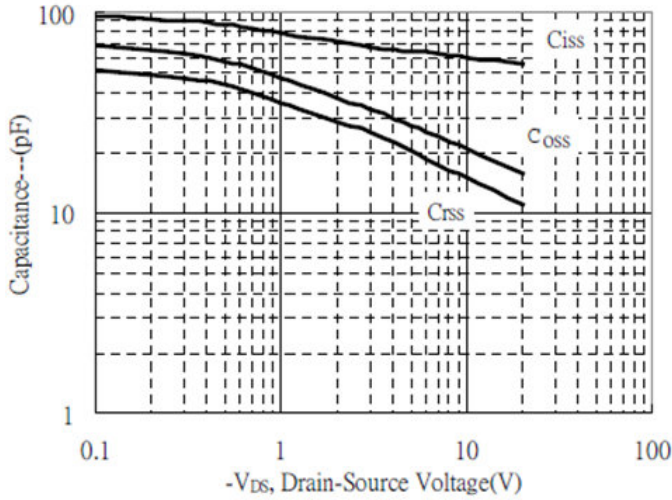

Threshold Voltage vs Junction Temperature

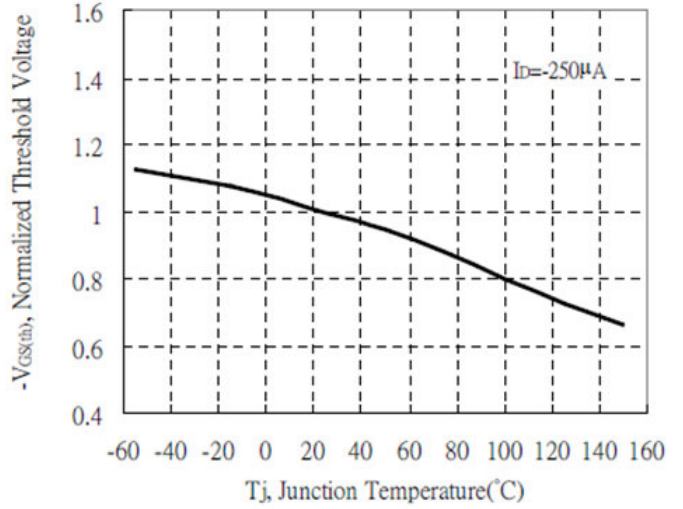

Maximum Safe Operating Area

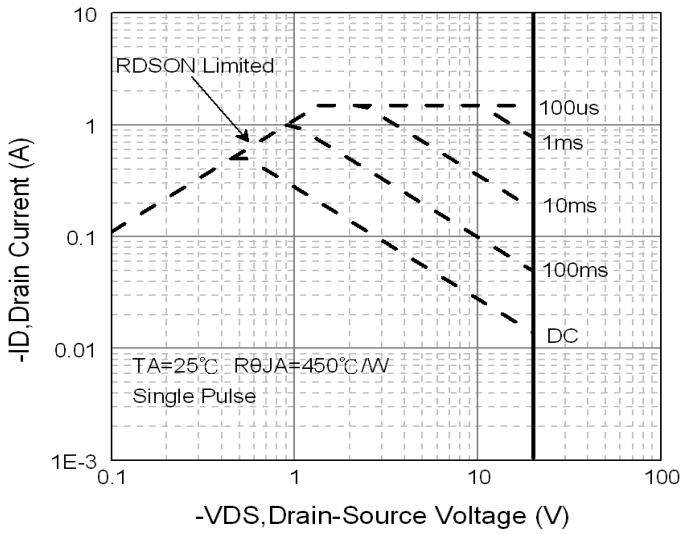

Gate Charge Characteristics

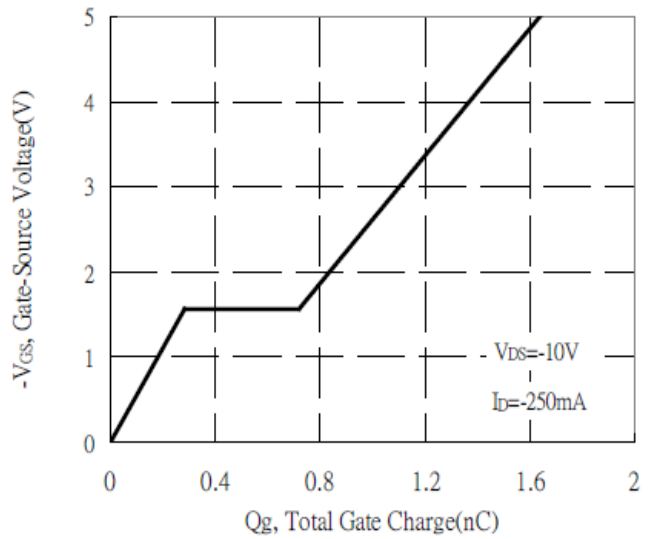

Transient Thermal Response Curves

