

- 8A Single Device Power
- Up to 90% efficiency (PT6501)
- Small SIP Footprint
- Standby Function
- Internal Short Circuit Protection
- Over-Temperature Protection
- Adjustable Output Voltage

The PT6500 series is a high performance +3.1 to 6V input, 8 Amp, 14-Pin SIP (Single In-line-Package) Inte-

grated Switching Regulator (ISR). This ISR allows the integration of high-speed, low-voltage Pentium processors and their support logic into existing 3.3V or 5V systems without redesigning the central power supply. The PT6502 (1.5V) provides the low terminating voltages required by BTL/ Futurebus+, CTT, HP, and GTL Buses from existing 3.3V or 5V power rails.

Standard Application

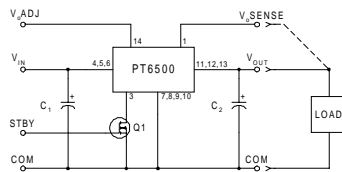

C₁ = Required 330µF electrolytic *
C₂ = Required 330µF electrolytic *
* See footnotes

Pin-Out Information

Pin	Function
1	Remote Sense
2	Do not connect
3	STBY*-Standby
4	V _{in}
5	V _{in}
6	V _{in}
7	GND
8	GND
9	GND
10	GND
11	V _{out}
12	V _{out}
13	V _{out}
14	V _{out} Adjust

Ordering Information

- PT6501□ = 3.3 Volts
 - †PT6502□ = 1.5 Volts
 - PT6503□ = 2.5 Volts
 - PT6504□ = 3.6 Volts
 - †PT6505□ = 1.2 Volts
 - †PT6506□ = 1.8 Volts
 - †PT6507□ = 1.3 Volts
 - †PT6508□ = 1.7 Volts
- †3.3V Input Bus Capable

PT Series Suffix (PT1234X)

Case/Pin Configuration	Heat Tab Configuration	
	None	Side
Vertical Through-Hole	N	R
Horizontal Through-Hole	A	G
Horizontal Surface Mount	C	B

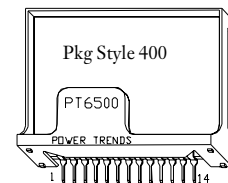

Specifications

Characteristics (T _a =25°C unless noted)	Symbols	Conditions	PT6500 SERIES			Units	
			Min	Typ	Max		
Output Current	I _o	Over V _{in} range	0.1 (1)	—	8.0	A	
Current Limit	I _{cl}	V _{in} =+5V	—	13.0	20.0	A	
Short Circuit Current	I _{sc}	V _{in} =+5V	—	15.0	—	Apk	
Input Voltage Range	V _{in}	0.1 ≤ I _o ≤ 8.0A	V _o =2.5V and 3.3V V _o ≤ 1.8V V _o = 3.6V	4.5 3.1 4.8	6 6 6	V	
Output Voltage Tolerance	ΔV _o	V _{in} = +5V, I _o = 8.0A T _a = 0 to +70°C	V _o -0.1	—	V _o +0.1	V	
Line Regulation	Reg _{line}	4.5V ≤ V _{in} ≤ 6.0V, I _o = 8.0A 3.1V ≤ V _{in} ≤ 6.0V, I _o = 8.0A 4.5V ≤ V _{in} ≤ 6.0V, I _o = 8.0A	V _o ≥ 3.3V V _o ≤ 1.8V V _o = 2.5V	— — —	±7 ±3 ±7	±17 ±8 ±13	mV
Load Regulation	Reg _{load}	0.1 ≤ I _o ≤ 8.0A, V _{in} = +5V	V _o ≥ 3.3V V _o ≤ 1.8V V _o = 2.5V	— — —	±17 ±12 ±13	±33 ±23 ±25	mV
V _o Ripple/Noise	V _n	V _{in} = +5V, I _o = 8.0 Amp	—	50	—	mVpp	
Transient Response with C _o = 330µF	t _{tr} V _{os}	I _o step from 4A to 8.0A V _o over/undershoot	— —	100 150	— —	µsec mV	
Efficiency	η	V _{in} = +5V, I _o = 3.0A	V _o ≥ 3.3V V _o = 2.5V V _o = 1.8V V _o = 1.5V V _o = 1.2V	— — — — —	90 85 78 76 67	— — — — —	%
		V _{in} = +5V, I _o = 8.0A	V _o ≥ 3.3V V _o = 2.5V V _o = 1.8V V _o = 1.5V V _o = 1.2V	— — — — —	83 76 74 68 65	— — — — —	%
Switching Frequency	f _o	Over V _{in} and I _o ranges	475	600	725	kHz	
Absolute Maximum Operating Temperature Range	T _a		-40 (3)	—	+85 (4)	°C	
Thermal Resistance	θ _{ja}	Free Air Convection (40-60LFM)	—	15	—	°C/W	

Continued

PT6500 Series

8 Amp 5V/3.3V Input Adjustable ISR
with Short-Circuit Protection

Specifications (continued)

Characteristics ($T_a=25^\circ\text{C}$ unless noted)	Symbols	Conditions	PT6500 SERIES			Units
			Min	Typ	Max	
Storage Temperature	T_s	—	-40	—	+125	$^\circ\text{C}$
Mechanical Shock	—	Per Mil-STD-883D, Method 2002.3, 1msec, half sine, fixture mounted	—	500	—	G's
Mechanical Vibration	—	Per Mil-STD-883D, Methode 2007.2, 20-20,000 Hz, soldered in a PC board	—	7.5	—	G's
Weight	—	—	—	23	—	grams

- Notes:**
- (1) ISR will operate down to no load with reduced specifications.
 - (2) The minimum input voltage required by the part is $V_{out} + 1.2V$ or $3.1V$, whichever is greater.
 - (3) For operation below 0°C , use tantalum capacitors. For more information see the related applicoatin note, "PT6000/7000 Series Capacitor Recommendations."
 - (4) See Thermal Derating charts.

Input/Output Capacitors: The PT6500 series requires a $330\mu\text{F}$ electrolytic or tantalum input and output capacitor for proper operation in all applications. C_1 (input) must be rated for 1.2Arms and $100\text{m}\Omega$ max. ESR. C_2 (output) must be rated for 400mArms ripple current and 0.2Ω max. ESR.

TYPICAL CHARACTERISTICS

PT6501, 3.3 VDC, $V_{in}=5.0V$

(See Note A)

Efficiency vs Output Current

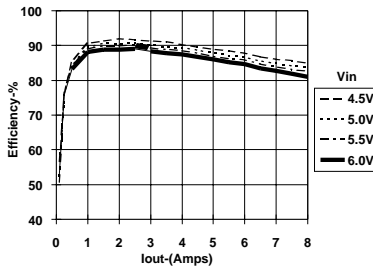

Ripple vs Output Current

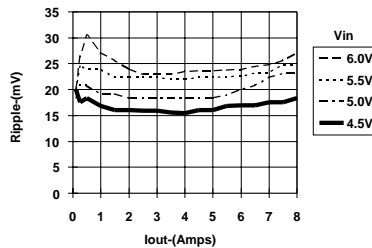

Power Dissipation vs Output Current

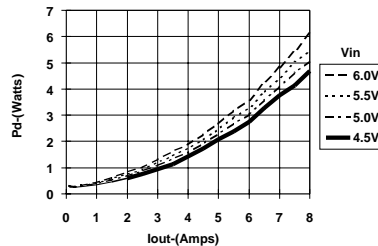

PT6502, 1.5 VDC, $V_{in}=5.0V$

(See Note A)

Efficiency vs Output Current

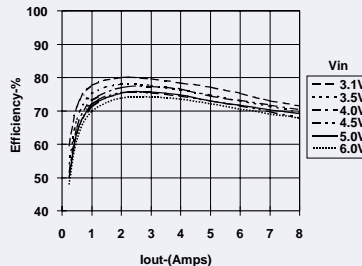

Ripple vs Output Current

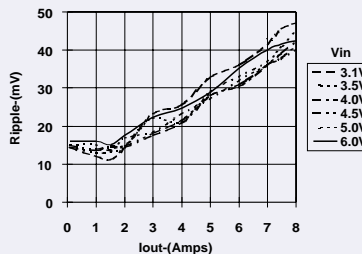

Power Dissipation vs Output Current

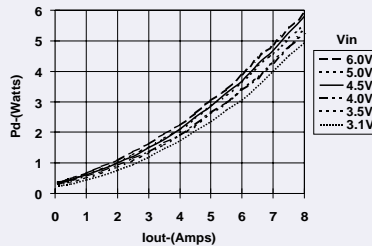

PT6503, 2.5 VDC, $V_{in}=5.0V$

(See Note A)

Efficiency vs Output Current

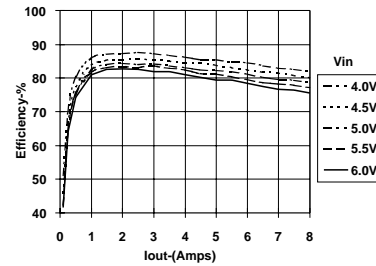

Ripple vs Output Current

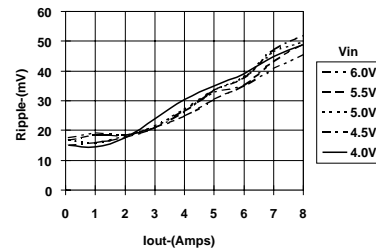

Power Dissipation vs Output Current

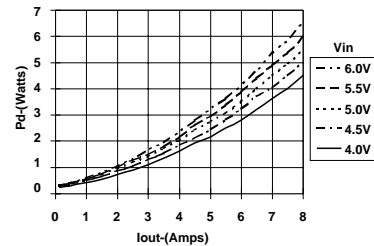

Note A: All data listed in the above graphs has been developed from actual products tested at 25°C . This data is considered typical data for the ISR.

THERMAL DERATING CURVES

Air Flow (LFM)

60

200

300

PT6501

No Heat Tab

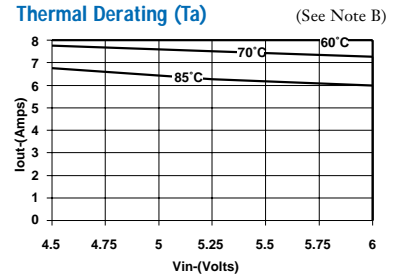
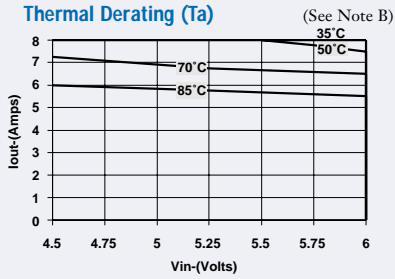
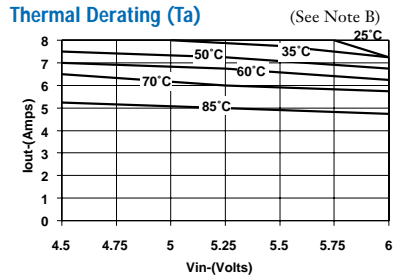

Heat Tab

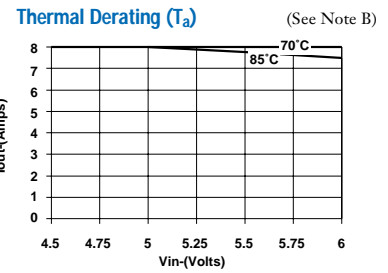
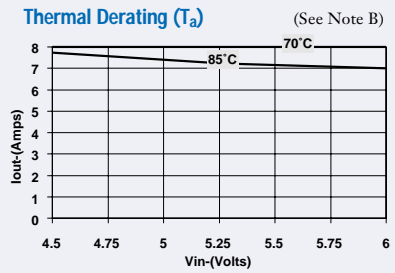
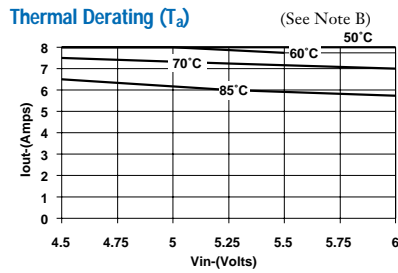

PT6502

No Heat Tab

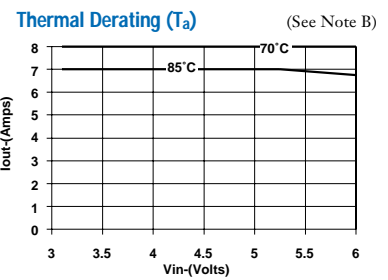
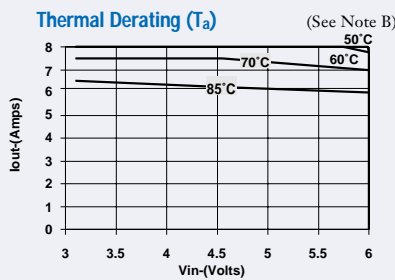
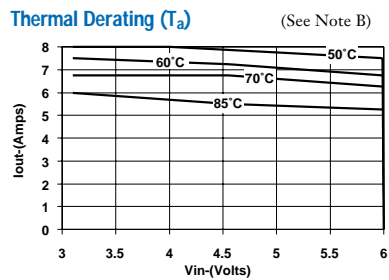

Heat Tab

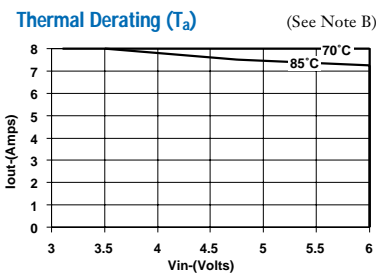
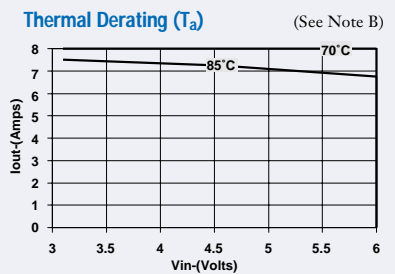
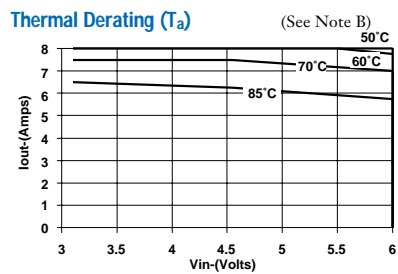

Note B: Thermal derating graphs are developed in different air flow rates as indicated on each graph, with or without the heat tab, soldered in a printed circuit board.

THERMAL DERATING CURVES

Air Flow (LFM)
60

200

300

PT6503

No Heat Tab

Thermal Derating (Ta) (See Note B)

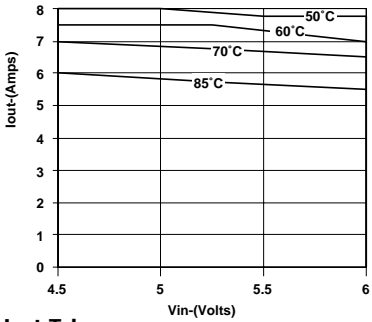

Thermal Derating (Ta) (See Note B)

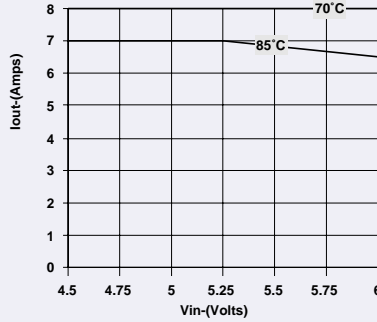

Thermal Derating (Ta) (See Note B)

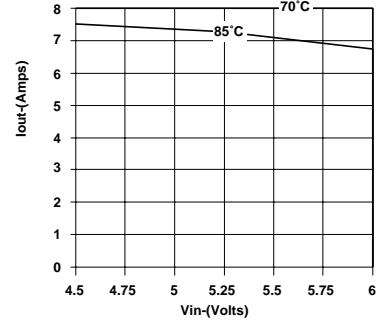

Heat Tab

Thermal Derating (Ta) (See Note B)

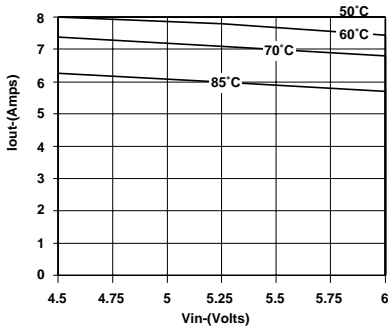

Thermal Derating (Ta) (See Note B)

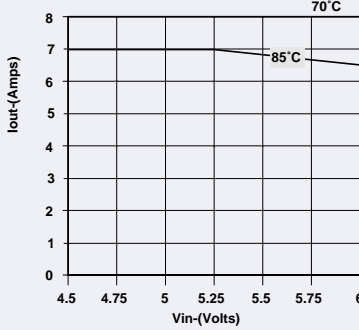

Thermal Derating (Ta) (See Note B)

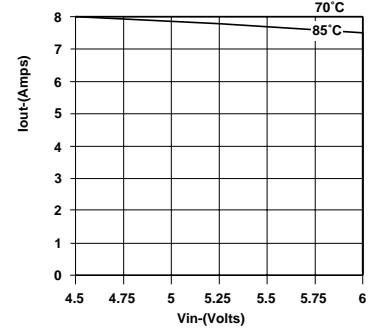

Note B: Thermal derating graphs are developed in different air flow rates as indicated on each graph, with or without the heat tab, soldered in a printed circuit board.

Adjusting the Output Voltage of the PT6500 5V/3.3V Bus Converters

The output voltage of the Power Trends PT6500 Series ISRs may be adjusted higher or lower than the factory trimmed pre-set voltage with the addition of a single external resistor. Table 1 accordingly gives the allowable adjustment range for each model in the series as V_a (min) and V_a (max).

Adjust Up: An increase in the output voltage is obtained by adding a resistor R2, between pin 14 (V_o adjust) and pins 7-10 (GND).

Adjust Down: Add a resistor (R1), between pin 14 (V_o adjust) and pins 11-13 (V_o adjust).

Refer to Figure 1 and Table 2 for both the placement and value of the required resistor, either (R1) or R2 as appropriate.

Notes:

1. Use only a single 1% resistor in either the (R1) or R2 location. Place the resistor as close to the ISR as possible.
2. Never connect capacitors from V_o adjust to either GND, V_{out} , or the Remote Sense pin. Any capacitance added to the V_o adjust pin will affect the stability of the ISR.
3. If the Remote Sense feature is being used, connecting the resistor (R1) between pin 14 (V_o adjust) and pin 1 (Remote Sense) can benefit load regulation.
4. The minimum input voltage required by the part is $V_{out} + 1.2$ or $V_{in}(min)$ from Table 1, whichever is higher.

Figure 1

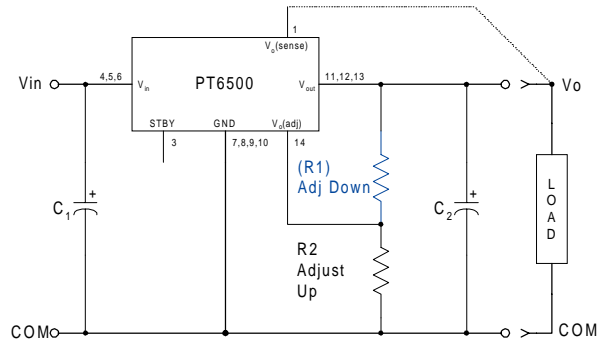

The values of (R1) [adjust down], and R2 [adjust up], can also be calculated using the following formulae.

$$(R1) = \frac{R_o (V_a - 1.0)}{(V_o - V_a)} - R_s \text{ k}\Omega$$

$$R2 = \frac{R_o}{V_a - V_o} - R_s \text{ k}\Omega$$

Where: V_o = Original output voltage
 V_a = Adjusted output voltage
 R_o = The resistance value in Table 1
 R_s = The series resistance from Table 1

Table 1

PT6500 ADJUSTMENT AND FORMULA PARAMETERS

Series Pt #	PT6505	PT6507	PT6502	PT6508	PT6506	PT6503	PT6501	PT6504
V_o (nom)	1.2	1.3	1.5	1.7	1.8	2.5	3.3	3.6
V_a (min)	1.14	1.19	1.27	1.36	1.4	1.8	2.25	2.5
V_a (max)	2.35	2.45	2.65	2.85	2.95	3.5	4.2	4.3
R_o (k Ω)	2.49	2.49	2.49	2.49	2.49	4.99	12.1	10.0
R_s (k Ω)	2.0	2.0	2.0	2.0	2.0	4.22	12.1	12.1
$V_{in}(min)$	3.1	3.1	3.1	3.1	3.1	4.5	4.5	4.5

PT6500 Series

Table 2

PT6500 ADJUSTMENT RESISTOR VALUES

Series Pt #	PT6505	PT6507	PT6502	PT6508	PT6506	PT6503	PT6501	PT6504
V _o (nom)	1.2	1.3	1.5	1.7	1.8	2.5	3.3	3.6
V _a (req'd)								
1.15	(5.5)kΩ							
1.2		(3.0)kΩ						
1.25	47.8kΩ	(10.5)kΩ						
1.3	22.9kΩ		(1.7)kΩ					
1.35	14.6kΩ	47.8kΩ	(3.8)kΩ					
1.4	10.5kΩ	22.9kΩ	(8.0)kΩ	(1.3)kΩ	(0.5)kΩ			
1.45	8.0kΩ	14.6kΩ	(20.4)kΩ	(2.5)kΩ	(1.2)kΩ			
1.5	6.3kΩ	10.5kΩ		(4.2)kΩ	(2.2)kΩ			
1.55	5.1kΩ	8.0kΩ	47.8kΩ	(7.1)kΩ	(3.5)kΩ			
1.6	4.2kΩ	6.3kΩ	22.9kΩ	(12.9)kΩ	(5.5)kΩ			
1.65	3.5kΩ	4.1kΩ	14.6kΩ	(30.4)kΩ	(8.8)kΩ			
1.7	3.0kΩ	4.2kΩ	10.5kΩ		(15.4)kΩ			
1.75	2.5kΩ	3.5kΩ	8.0kΩ	47.8kΩ	(35.4)kΩ			
1.8	2.2kΩ	3.0kΩ	6.3kΩ	22.9kΩ		(1.5)kΩ		
1.85	1.8kΩ	2.5kΩ	5.1kΩ	14.6kΩ	47.8kΩ	(2.3)kΩ		
1.9	1.6kΩ	2.2kΩ	4.2kΩ	10.5kΩ	22.9kΩ	(3.3)kΩ		
1.95	1.3kΩ	1.8kΩ	3.5kΩ	8.0kΩ	14.6kΩ	(4.4)kΩ		
2.0	1.1kΩ	1.6kΩ	3.0kΩ	6.3kΩ	10.5kΩ	(5.8)kΩ		
2.05	0.9kΩ	1.3kΩ	2.5kΩ	5.1kΩ	8.0kΩ	(7.4)kΩ		
2.1	0.8kΩ	1.1kΩ	2.2kΩ	4.2kΩ	6.3kΩ	(9.5)kΩ		
2.15	0.6kΩ	0.9kΩ	1.8kΩ	3.5kΩ	5.1kΩ	(12.2)kΩ		
2.2	0.5kΩ	0.8kΩ	1.6kΩ	3.0kΩ	4.2kΩ	(15.7)kΩ		
2.25	0.4kΩ	0.6kΩ	1.3kΩ	2.5kΩ	3.5kΩ	(20.7)kΩ	(2.3)kΩ	
2.3	0.3kΩ	0.5kΩ	1.1kΩ	2.2kΩ	3.0kΩ	(28.2)kΩ	(3.6)kΩ	
2.35	0.2kΩ	0.4kΩ	0.9kΩ	1.8kΩ	2.5kΩ	(40.7)kΩ	(5.1)kΩ	
2.4		0.3kΩ	0.8kΩ	1.6kΩ	2.2kΩ	(65.6)kΩ	(6.7)kΩ	
2.45		0.2kΩ	0.6kΩ	1.3kΩ	1.8kΩ	(140.0)kΩ	(8.5)kΩ	
2.5			0.5kΩ	1.1kΩ	1.6kΩ		(10.6)kΩ	(1.5)kΩ
2.55			0.4kΩ	0.9kΩ	1.3kΩ	95.6kΩ	(12.9)kΩ	(2.7)kΩ
2.6			0.3kΩ	0.8kΩ	1.1kΩ	45.7kΩ	(15.6)kΩ	(3.9)kΩ
2.65			0.2kΩ	0.6kΩ	0.9kΩ	29.0kΩ	(18.6)kΩ	(5.3)kΩ
2.7				0.5kΩ	0.8kΩ	20.7kΩ	(22.2)kΩ	(6.8)kΩ
2.75				0.4kΩ	0.6kΩ	15.7kΩ	(26.4)kΩ	(8.5)kΩ
2.8				0.3kΩ	0.5kΩ	12.4kΩ	(31.5)kΩ	(10.4)kΩ
2.85				0.2kΩ	0.4kΩ	10.0kΩ	(37.6)kΩ	(12.6)kΩ
2.9					0.3kΩ	8.3kΩ	(45.4)kΩ	(15.0)kΩ
2.95					0.2kΩ	0.9kΩ	(55.3)kΩ	(17.9)kΩ
3.0						5.8kΩ	(68.6)kΩ	(21.2)kΩ
3.1						4.1kΩ	(115.0)kΩ	(29.9)kΩ
3.2						2.9kΩ	(254.0)kΩ	(42.9)kΩ
3.3						2.0kΩ		(64.6)kΩ
3.4						1.3kΩ	109.0kΩ	(108.0)kΩ
3.5						0.8kΩ	48.4kΩ	(238.0)kΩ
3.6							28.2kΩ	
3.7							18.2kΩ	87.9kΩ
3.8							12.1kΩ	37.9kΩ
3.9	4/. V _{out} >3.8Vdc requires V _{in} >5.0Vdc !						8.1kΩ	21.2kΩ
4.0							5.2kΩ	12.9kΩ
4.1							3.0kΩ	7.9kΩ
4.2							1.3kΩ	4.6kΩ
4.3								2.2kΩ

R1 = (Blue) R2 = Black

Using the Standby Function on the PT6500 5V/3.3V Bus Converters

For applications requiring output voltage On/Off control, the 14-pin PT6500 ISR series incorporates a standby function. This function may be used in applications that require power-up/shutdown sequencing, and wherever there is a requirement for the output status of the module to be controlled by external circuitry.

The standby function is provided by the *STBY** control, pin 3. If pin 3 is left open-circuit the regulator operates normally, and provides a regulated output when a valid supply voltage is applied to V_{in} (pins 4, 5, & 6) with respect to GND (pins 7-10). If a low voltage² is then applied to pin-3 the regulator output will be disabled and the input current drawn by the ISR will drop to less than 50mA⁴. The standby control may also be used to hold-off the regulator output during the period that input power is applied.

The standby control pin is ideally controlled using an open-collector (or open-drain) discrete transistor (See Figure 1). It may also be driven directly from a dedicated TTL³ compatible gate. Table 1 provides details of the threshold requirements.

Table 1 Inhibit Control Thresholds (2,3)

Parameter	Min	Max
Enable (V _{IH})	1V	5V
Disable (V _{IL})	-0.1V	0.35V

Notes:

1. The Standby/Inhibit control logic is similar for all Power Trends' modules, but the flexibility and threshold tolerances will be different. For specific information on this function for other regulator models, consult the applicable application note.
2. The Standby control pin is ideally controlled using an open-collector (or open-drain) discrete transistor and requires no external pull-up resistor. The control input has an open-circuit voltage of about 1Vdc. To disable the regulator output, the control pin must be pulled to less than 0.35Vdc with a low-level 0.5mA sink to ground.
3. The Standby input on the PT6500 series may be driven by a differential output device, making it compatible with TTL logic. A standard TTL logic gate will meet the 0.35V V_{IL(max)} requirement (Table 1) at 0.5mA I_{OL}. Do not use devices that can drive the Standby control input above 5Vdc.
4. When the regulator output is disabled the current drawn from the input source is reduced to approximately 30–40mA (50mA maximum).

Figure 1

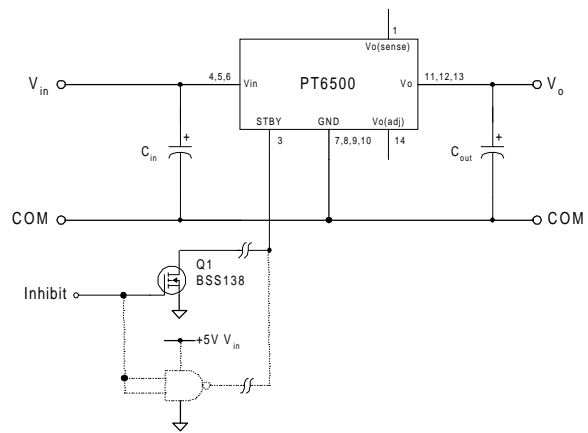

Turn-On Time: In the circuit of Figure 1, turning Q₁ on applies a low voltage to the Standby control (pin 3) and disables the regulator output. Correspondingly, turning Q₁ off releases the low-voltage signal and enables the output. The PT6500 ISR series regulators have a fast response and will provide a fully regulated output voltage within 250 μsec. The actual turn-on time will vary with load and the total amount of output capacitance. The waveform of Figure 2 shows the typical output voltage response of a PT6501 (3.3V) following the turn-off of Q₁ at time t = 0.0 secs. The waveform was measured with a 5Vdc input voltage, and 0.6Ω load.

Figure 2

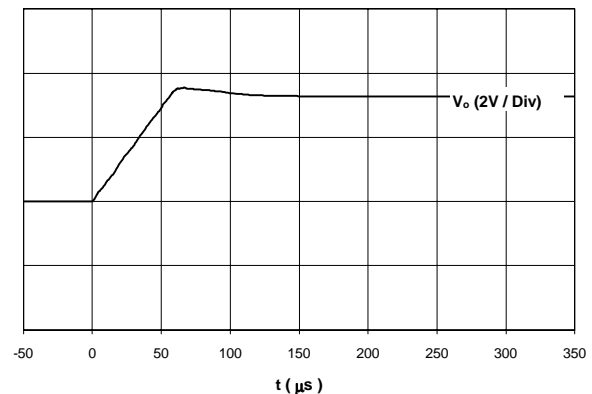

PACKAGING INFORMATION

Orderable Device	Status (1)	Package Type	Package Drawing	Pins	Package Qty	Eco Plan (2)	Lead/Ball Finish (6)	MSL Peak Temp (3)	Op Temp (°C)	Device Marking (4/5)	Samples
PT6501C	OBSOLETE	SIP MODULE	EEC	14		TBD	Call TI	Call TI			
PT6502A	OBSOLETE	SIP MODULE	EEA	14		TBD	Call TI	Call TI			
PT6503C	OBSOLETE	SIP MODULE	EEC	14		TBD	Call TI	Call TI			
PT6506E	OBSOLETE	SIP MODULE	EEC	14		TBD	Call TI	Call TI			
PT6506F	OBSOLETE	SIP MODULE	EEF	14		TBD	Call TI	Call TI			
PT6506N	OBSOLETE	SIP MODULE	EED	14		TBD	Call TI	Call TI			
PT6507A	OBSOLETE	SIP MODULE	EEA	14		TBD	Call TI	Call TI	0 to 70		
PT6507B	OBSOLETE	SIP MODULE	EEK	14		TBD	Call TI	Call TI	0 to 70		
PT6507C	OBSOLETE	SIP MODULE	EEC	14		TBD	Call TI	Call TI	0 to 70		
PT6507F	OBSOLETE	SIP MODULE	EEF	14		TBD	Call TI	Call TI	0 to 70		
PT6507G	OBSOLETE	SIP MODULE	EEG	14		TBD	Call TI	Call TI	0 to 70		
PT6507L	OBSOLETE	SIP MODULE	EEL	14		TBD	Call TI	Call TI	0 to 70		
PT6507M	OBSOLETE	SIP MODULE	EEM	14		TBD	Call TI	Call TI	0 to 70		
PT6507N	OBSOLETE	SIP MODULE	EED	14		TBD	Call TI	Call TI	0 to 70		
PT6507Q	OBSOLETE	SIP MODULE	EEQ	14		TBD	Call TI	Call TI	0 to 70		
PT6507R	OBSOLETE	SIP MODULE	EEE	14		TBD	Call TI	Call TI	0 to 70		
PT6508A	OBSOLETE	SIP MODULE	EEA	14		TBD	Call TI	Call TI			
PT6508B	OBSOLETE	SIP MODULE	EEK	14		TBD	Call TI	Call TI			
PT6508C	OBSOLETE	SIP MODULE	EEC	14		TBD	Call TI	Call TI			
PT6508F	OBSOLETE	SIP MODULE	EEF	14		TBD	Call TI	Call TI			
PT6508G	OBSOLETE	SIP MODULE	EEG	14		TBD	Call TI	Call TI			
PT6508L	OBSOLETE	SIP MODULE	EEL	14		TBD	Call TI	Call TI			
PT6508M	OBSOLETE	SIP MODULE	EEM	14		TBD	Call TI	Call TI			
PT6508N	OBSOLETE	SIP MODULE	EED	14		TBD	Call TI	Call TI			
PT6508Q	OBSOLETE	SIP MODULE	EEQ	14		TBD	Call TI	Call TI			
PT6508R	OBSOLETE	SIP MODULE	EEE	14		TBD	Call TI	Call TI			

⁽¹⁾ The marketing status values are defined as follows:

ACTIVE: Product device recommended for new designs.

LIFEBUY: TI has announced that the device will be discontinued, and a lifetime-buy period is in effect.

NRND: Not recommended for new designs. Device is in production to support existing customers, but TI does not recommend using this part in a new design.

PREVIEW: Device has been announced but is not in production. Samples may or may not be available.

OBSOLETE: TI has discontinued the production of the device.

⁽²⁾ Eco Plan - The planned eco-friendly classification: Pb-Free (RoHS), Pb-Free (RoHS Exempt), or Green (RoHS & no Sb/Br) - please check <http://www.ti.com/productcontent> for the latest availability information and additional product content details.

TBD: The Pb-Free/Green conversion plan has not been defined.

Pb-Free (RoHS): TI's terms "Lead-Free" or "Pb-Free" mean semiconductor products that are compatible with the current RoHS requirements for all 6 substances, including the requirement that lead not exceed 0.1% by weight in homogeneous materials. Where designed to be soldered at high temperatures, TI Pb-Free products are suitable for use in specified lead-free processes.

Pb-Free (RoHS Exempt): This component has a RoHS exemption for either 1) lead-based flip-chip solder bumps used between the die and package, or 2) lead-based die adhesive used between the die and leadframe. The component is otherwise considered Pb-Free (RoHS compatible) as defined above.

Green (RoHS & no Sb/Br): TI defines "Green" to mean Pb-Free (RoHS compatible), and free of Bromine (Br) and Antimony (Sb) based flame retardants (Br or Sb do not exceed 0.1% by weight in homogeneous material)

⁽³⁾ MSL, Peak Temp. - The Moisture Sensitivity Level rating according to the JEDEC industry standard classifications, and peak solder temperature.

⁽⁴⁾ There may be additional marking, which relates to the logo, the lot trace code information, or the environmental category on the device.

⁽⁵⁾ Multiple Device Markings will be inside parentheses. Only one Device Marking contained in parentheses and separated by a "~" will appear on a device. If a line is indented then it is a continuation of the previous line and the two combined represent the entire Device Marking for that device.

⁽⁶⁾ Lead/Ball Finish - Orderable Devices may have multiple material finish options. Finish options are separated by a vertical ruled line. Lead/Ball Finish values may wrap to two lines if the finish value exceeds the maximum column width.

Important Information and Disclaimer: The information provided on this page represents TI's knowledge and belief as of the date that it is provided. TI bases its knowledge and belief on information provided by third parties, and makes no representation or warranty as to the accuracy of such information. Efforts are underway to better integrate information from third parties. TI has taken and continues to take reasonable steps to provide representative and accurate information but may not have conducted destructive testing or chemical analysis on incoming materials and chemicals. TI and TI suppliers consider certain information to be proprietary, and thus CAS numbers and other limited information may not be available for release.

In no event shall TI's liability arising out of such information exceed the total purchase price of the TI part(s) at issue in this document sold by TI to Customer on an annual basis.

IMPORTANT NOTICE

Texas Instruments Incorporated and its subsidiaries (TI) reserve the right to make corrections, enhancements, improvements and other changes to its semiconductor products and services per JESD46, latest issue, and to discontinue any product or service per JESD48, latest issue. Buyers should obtain the latest relevant information before placing orders and should verify that such information is current and complete. All semiconductor products (also referred to herein as "components") are sold subject to TI's terms and conditions of sale supplied at the time of order acknowledgment.

TI warrants performance of its components to the specifications applicable at the time of sale, in accordance with the warranty in TI's terms and conditions of sale of semiconductor products. Testing and other quality control techniques are used to the extent TI deems necessary to support this warranty. Except where mandated by applicable law, testing of all parameters of each component is not necessarily performed.

TI assumes no liability for applications assistance or the design of Buyers' products. Buyers are responsible for their products and applications using TI components. To minimize the risks associated with Buyers' products and applications, Buyers should provide adequate design and operating safeguards.

TI does not warrant or represent that any license, either express or implied, is granted under any patent right, copyright, mask work right, or other intellectual property right relating to any combination, machine, or process in which TI components or services are used. Information published by TI regarding third-party products or services does not constitute a license to use such products or services or a warranty or endorsement thereof. Use of such information may require a license from a third party under the patents or other intellectual property of the third party, or a license from TI under the patents or other intellectual property of TI.

Reproduction of significant portions of TI information in TI data books or data sheets is permissible only if reproduction is without alteration and is accompanied by all associated warranties, conditions, limitations, and notices. TI is not responsible or liable for such altered documentation. Information of third parties may be subject to additional restrictions.

Resale of TI components or services with statements different from or beyond the parameters stated by TI for that component or service voids all express and any implied warranties for the associated TI component or service and is an unfair and deceptive business practice. TI is not responsible or liable for any such statements.

Buyer acknowledges and agrees that it is solely responsible for compliance with all legal, regulatory and safety-related requirements concerning its products, and any use of TI components in its applications, notwithstanding any applications-related information or support that may be provided by TI. Buyer represents and agrees that it has all the necessary expertise to create and implement safeguards which anticipate dangerous consequences of failures, monitor failures and their consequences, lessen the likelihood of failures that might cause harm and take appropriate remedial actions. Buyer will fully indemnify TI and its representatives against any damages arising out of the use of any TI components in safety-critical applications.

In some cases, TI components may be promoted specifically to facilitate safety-related applications. With such components, TI's goal is to help enable customers to design and create their own end-product solutions that meet applicable functional safety standards and requirements. Nonetheless, such components are subject to these terms.

No TI components are authorized for use in FDA Class III (or similar life-critical medical equipment) unless authorized officers of the parties have executed a special agreement specifically governing such use.

Only those TI components which TI has specifically designated as military grade or "enhanced plastic" are designed and intended for use in military/aerospace applications or environments. Buyer acknowledges and agrees that any military or aerospace use of TI components which have **not** been so designated is solely at the Buyer's risk, and that Buyer is solely responsible for compliance with all legal and regulatory requirements in connection with such use.

TI has specifically designated certain components as meeting ISO/TS16949 requirements, mainly for automotive use. In any case of use of non-designated products, TI will not be responsible for any failure to meet ISO/TS16949.

Products

Audio	www.ti.com/audio
Amplifiers	amplifier.ti.com
Data Converters	dataconverter.ti.com
DLP® Products	www.dlp.com
DSP	dsp.ti.com
Clocks and Timers	www.ti.com/clocks
Interface	interface.ti.com
Logic	logic.ti.com
Power Mgmt	power.ti.com
Microcontrollers	microcontroller.ti.com
RFID	www.ti-rfid.com
OMAP Applications Processors	www.ti.com/omap
Wireless Connectivity	www.ti.com/wirelessconnectivity

Applications

Automotive and Transportation	www.ti.com/automotive
Communications and Telecom	www.ti.com/communications
Computers and Peripherals	www.ti.com/computers
Consumer Electronics	www.ti.com/consumer-apps
Energy and Lighting	www.ti.com/energy
Industrial	www.ti.com/industrial
Medical	www.ti.com/medical
Security	www.ti.com/security
Space, Avionics and Defense	www.ti.com/space-avionics-defense
Video and Imaging	www.ti.com/video

TI E2E Community

e2e.ti.com