

CMPA1D1E080F

80 W, 13.75 - 14.5 GHz, 40 V, Ku-Band GaN, Power Amplifier

Cree's CMPA1D1E080F is a Gallium Nitride (GaN) High Electron Mobility Transistor (HEMT) based Monolithic Microwave Integrated Circuit (MMIC). It is designed specifically for high efficiency, high gain, and wide bandwidth capabilities while meeting OQPSK linearity, which makes CMPA1D1E080F ideal for 13.75 - 14.5 GHz commercial Ku Band satellite communications applications. The transistor is supplied in a 14 lead metal/ceramic flange package.

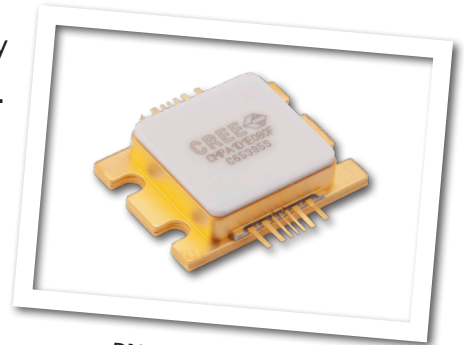

PN: CMPA1D1E080F
Package Type:440222

Typical Performance Over 13.75 - 14.5 GHz ($T_c = 25^\circ\text{C}$)

Parameter	13.75 GHz	14 GHz	14.25 GHz	14.5 GHz	Units
Small Signal Gain	28.8	28.3	29	28.6	dB
ACLR ¹	-29.3	-29.5	-27.3	-24.5	dBc
Power Gain ¹	25.3	24	24.7	22.4	dB
Power Added Efficiency ¹	18.3	17.3	18.2	18.5	%

Note¹: Measured at $P_{AVE} = 46\text{ dBm}$ in the CMPA1D1E080F-AMP under OQPSK modulation, 1.6 Msps, PN23, Alpha Filter = 0.2.

Features

- 28 dB Small Signal Gain
- 80 W CW Power
- 500 MHz Video Bandwidth
- 40 W Linear Power Under OQPSK

Applications

- Satellite Communications Uplink



Absolute Maximum Ratings (not simultaneous)

Parameter	Symbol	Rating	Units	Conditions
Drain-source Voltage	V_{DSS}	84	V_{DC}	25°C
Gate-source Voltage	V_{GS}	-10, +2	V_{DC}	25°C
Storage Temperature	T_{STG}	-55, +150	°C	
Operating Junction Temperature	T_J	225	°C	
Maximum Forward Gate Current	I_{GMAX}	49	mA	25°C
Soldering Temperature ¹	T_S	245	°C	
Screw Torque	τ	40	in-oz	
Thermal Resistance, Junction to Case	$R_{\theta JC}$	0.57	°C/W	$P_{DISS} = 246 \text{ W}, 60^\circ\text{C}, \text{CW}$
Case Operating Temperature	T_C	-40, +60	°C	

Note:

¹ Refer to the Application Note on soldering at www.cree.com/products/wireless_appnotes.asp

Electrical Characteristics (Frequency = 13.75 GHz to 14.5 GHz unless otherwise stated; $T_C = 25^\circ\text{C}$)

Characteristics	Symbol	Min.	Typ.	Max.	Units	Conditions
DC Characteristics¹						
Gate Threshold	$V_{GS(TH)}$	-3.8	-3.0	-2.3	V	$V_{DS} = 10 \text{ V}, I_D = 49.2 \text{ mA}$
Gate Quiescent Voltage	V_Q	-	-2.7	-	V	$V_{DS} = 40 \text{ V}, I_D = 640 \text{ mA}$
Saturated Drain Current ²	I_{DS}	36.9	44.3	-	A	$V_{DS} = 6.0 \text{ V}, V_{GS} = 2.0 \text{ V}$
Drain-Source Breakdown Voltage	V_{BD}	84	100	-	V	$V_{GS} = -8 \text{ V}, I_D = 49.2 \text{ mA}$
RF Characteristics^{3, 4, 5, 6}						
Small Signal Gain	S21	-	28.7	-	dB	$V_{DD} = 40 \text{ V}, I_{DQ} = 640 \text{ mA}, P_{IN} = -30 \text{ dBm}$
Input Return Loss	S11	-	-8.7	-	dB	$V_{DD} = 40 \text{ V}, I_{DQ} = 640 \text{ mA}, P_{IN} = -30 \text{ dBm}$
Output Return Loss	S22	-	-10.2	-	dB	$V_{DD} = 40 \text{ V}, I_{DQ} = 640 \text{ mA}, P_{IN} = -30 \text{ dBm}$
Power Added Efficiency	PAE ₁	-	18.3	-	%	$V_{DD} = 40 \text{ V}, I_{DQ} = 640 \text{ mA}, \text{Frequency} = 13.75 \text{ GHz}$
Power Added Efficiency	PAE ₂	-	17.3	-	%	$V_{DD} = 40 \text{ V}, I_{DQ} = 640 \text{ mA}, \text{Frequency} = 14 \text{ GHz}$
Power Added Efficiency	PAE ₃	-	18.2	-	%	$V_{DD} = 40 \text{ V}, I_{DQ} = 640 \text{ mA}, \text{Frequency} = 14.25 \text{ GHz}$
Power Added Efficiency	PAE ₄	-	18.5	-	%	$V_{DD} = 40 \text{ V}, I_{DQ} = 640 \text{ mA}, \text{Frequency} = 14.5 \text{ GHz}$
Power Gain	G _{P1}	-	25.3	-	dB	$V_{DD} = 40 \text{ V}, I_{DQ} = 640 \text{ mA}, \text{Frequency} = 13.75 \text{ GHz}$
Power Gain	G _{P2}	-	24	-	dB	$V_{DD} = 40 \text{ V}, I_{DQ} = 640 \text{ mA}, \text{Frequency} = 14 \text{ GHz}$
Power Gain	G _{P3}	-	24.7	-	dB	$V_{DD} = 40 \text{ V}, I_{DQ} = 640 \text{ mA}, \text{Frequency} = 14.25 \text{ GHz}$
Power Gain	G _{P4}	-	22.4	-	dB	$V_{DD} = 40 \text{ V}, I_{DQ} = 640 \text{ mA}, \text{Frequency} = 14.5 \text{ GHz}$
OQPSK Linearity	ACLR ₁	-	-29.3	-	dBc	$V_{DD} = 40 \text{ V}, I_{DQ} = 640 \text{ mA}, \text{Frequency} = 13.75 \text{ GHz}$
OQPSK Linearity	ACLR ₂	-	-29.5	-	dBc	$V_{DD} = 40 \text{ V}, I_{DQ} = 640 \text{ mA}, \text{Frequency} = 14 \text{ GHz}$
OQPSK Linearity	ACLR ₃	-	-27.3	-	dBc	$V_{DD} = 40 \text{ V}, I_{DQ} = 640 \text{ mA}, \text{Frequency} = 14.25 \text{ GHz}$
OQPSK Linearity	ACLR ₄	-	-24.5	-	dBc	$V_{DD} = 40 \text{ V}, I_{DQ} = 640 \text{ mA}, \text{Frequency} = 14.5 \text{ GHz}$
Output Mismatch Stress	V_{SWR}	-	-	3 : 1	Ψ	No damage at all phase angles, $V_{DD} = 40 \text{ V}, I_{DQ} = 640 \text{ mA}, P_{OUT} = 46 \text{ dBm OQPSK}$

Notes:

¹ Measured on-wafer prior to packaging.

² Scaled from PCM data.

³ Measured in the CMPA1D1E080F-AMP

⁴ Under OQPSK modulated signal, 1.6 Msps, PN23, Alpha Filter = 0.2

⁵ Measured at $P_{AVE} = 46 \text{ dBm}$

⁶ Fixture loss de-embedded

Typical Performance

Figure 1. - Small Signal S-parameters - Gain, Return Losses vs Frequency of CMPA1D1E080F in Demonstration Test Fixture CMPA1D1E080F-TB
 $V_{DD} = 40\text{ V}$, $I_{DQ} = 640\text{ mA}$, $T_{case} = 25^\circ\text{C}$

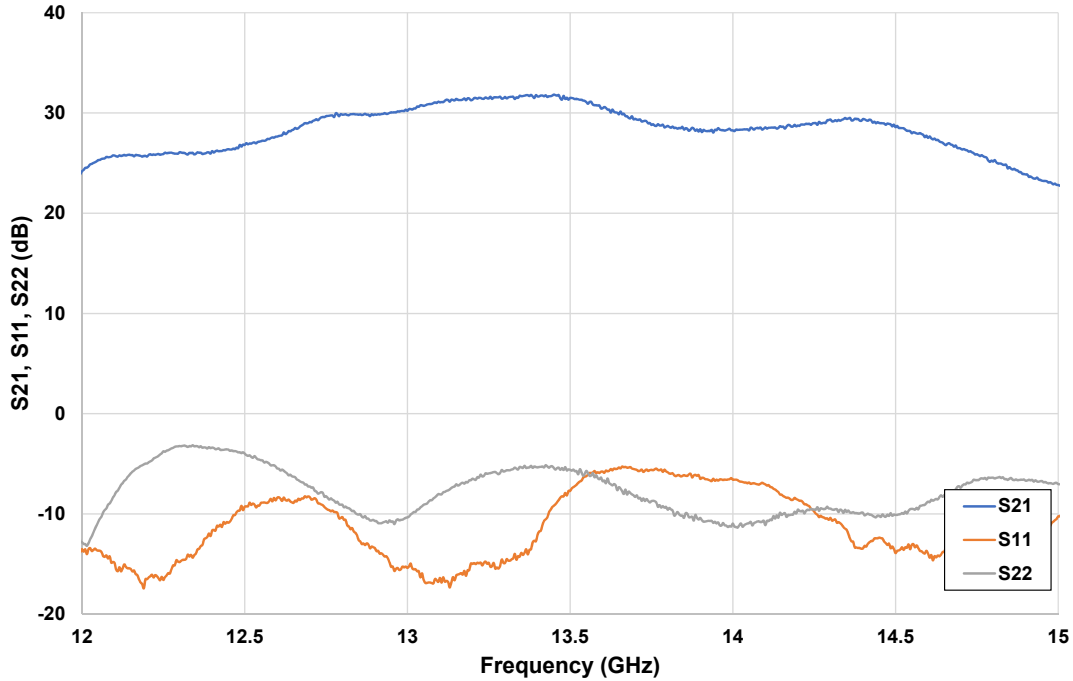
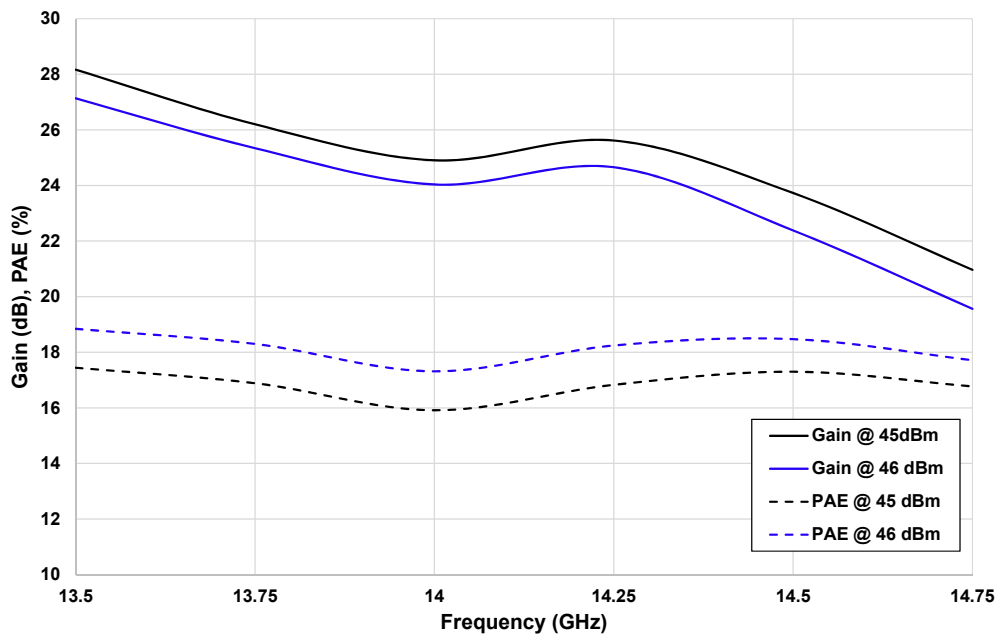

Figure 2. - Gain and Power Added Efficiency vs Frequency at $P_{AVE} = 45$ and 46 dBm , OQPSK Modulation, 1.6 Msps, PN23, Alpha Filter = 0.2
 $V_{DD} = 40\text{ V}$, $I_{DQ} = 640\text{ mA}$, $Temp = 25^\circ\text{C}$



Typical Performance

Figure 3. - ACLR and Gain vs Frequency at $P_{AVE} = 45$ and 46 dBm, OQPSK Modulation, 1.6 Msp/s, PN23, Alpha Filter = 0.2
 $V_{DD} = 40$ V, $I_{DQ} = 640$ mA, Temp = 25°C

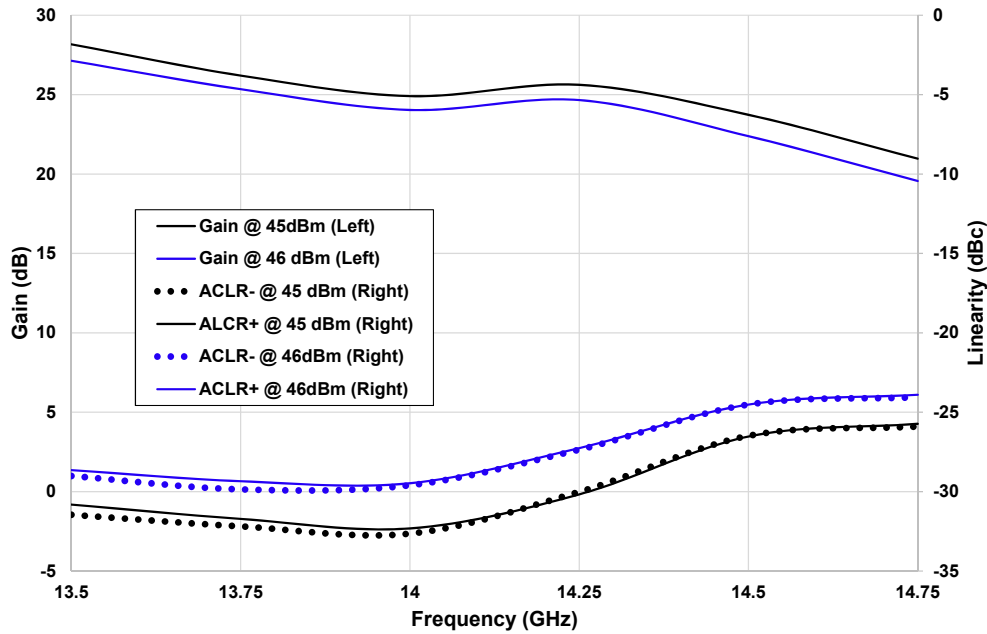
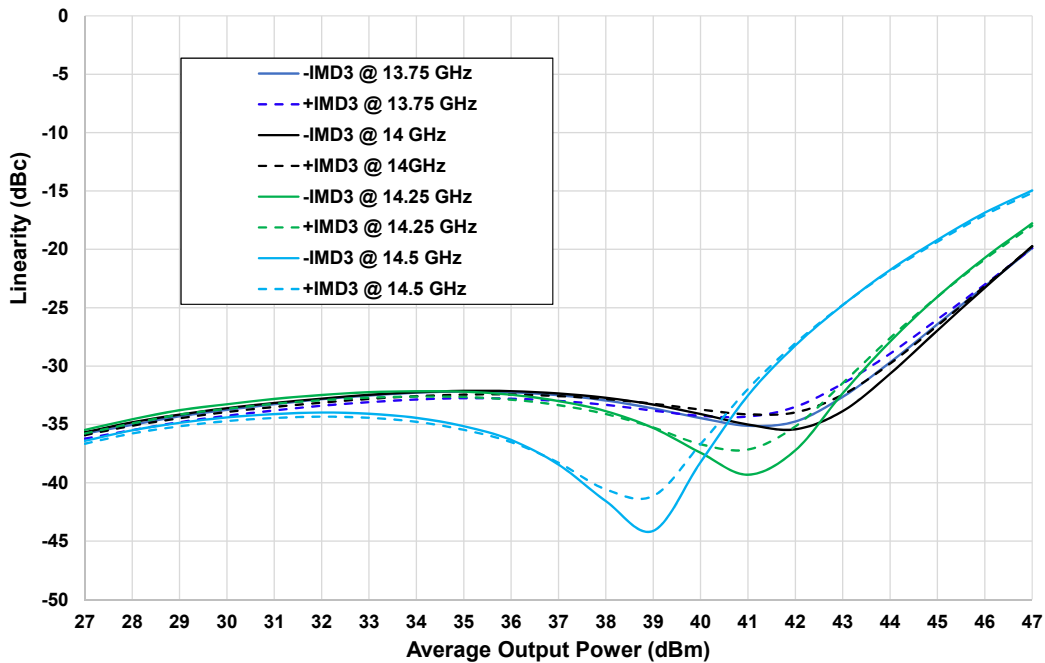
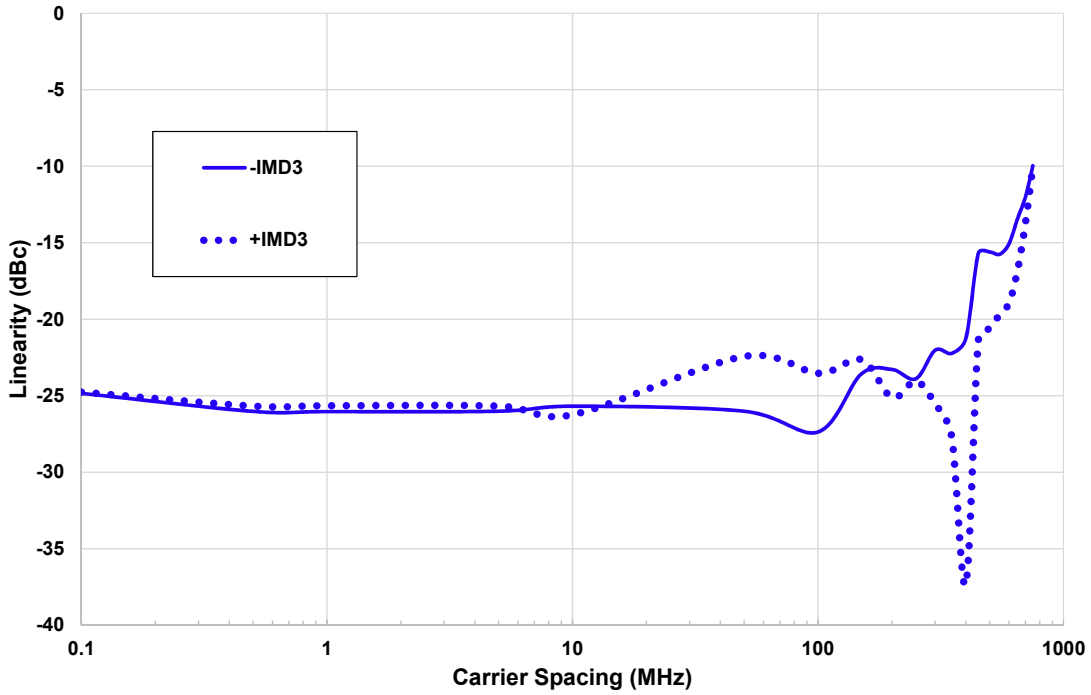

Figure 4. - CMPA1D1E080F Two Tone Power Sweep IMD3 @ 1 MHz Carrier Spacing vs Output Power
 $V_{DD} = 40$ V, $I_{DQ} = 640$ mA, Tcase = 25°C



Typical Performance

Figure 5. - Two Tone Carrier Spacing Sweep @ 46 dBm Average Output Power at 14 GHz
 $V_{DD} = 40\text{ V}$, $I_{DQ} = 640\text{ mA}$, $T_{case} = 25^{\circ}\text{C}$



CMPA1D1E080F-AMP Demonstration Amplifier Circuit Bill of Materials

Designator	Description	Qty
C1,C3	CAP, 33000PF, 0805,100V, X7R	2
C2,C4,C6,C9	CAP, 2.2UF, 100V, 10%, X7R, 1210	4
C7,C10	CAP, 10UF, 100V, 10%, X7R, 2220	2
C11	CAP, 100 UF, 20%, 160V, ELEC	1
W1,W2, W3	WIRE, ORANGE, 18 AWG ~ 1.75"	3
J1,J2	CONN, SMA, PANEL MOUNT JACK, FLANGE, 4-HOLE, BLUNT POST, 20MIL	2
J3,J4	HEADER RT>PLZ .1CEN LK 9POS	2
J5	CONN, SMB, STRAIGHT JACK RECEPTACLE, SMT, 50 OHM, Au PLATED	1
Q1	CMPA1D1E080F, MMIC	1
	PCB, TEST FIXTURE, 440222 PKG	1
	BASEPLATE, CU, 2.5 X 4.0 X 0.5 IN	1
	2-56 SOC HD SCREW 1/4 SS	4
	#2 SPLIT LOCKWASHER SS	4

CMPA1D1E080F-AMP Demonstration Amplifier Circuit

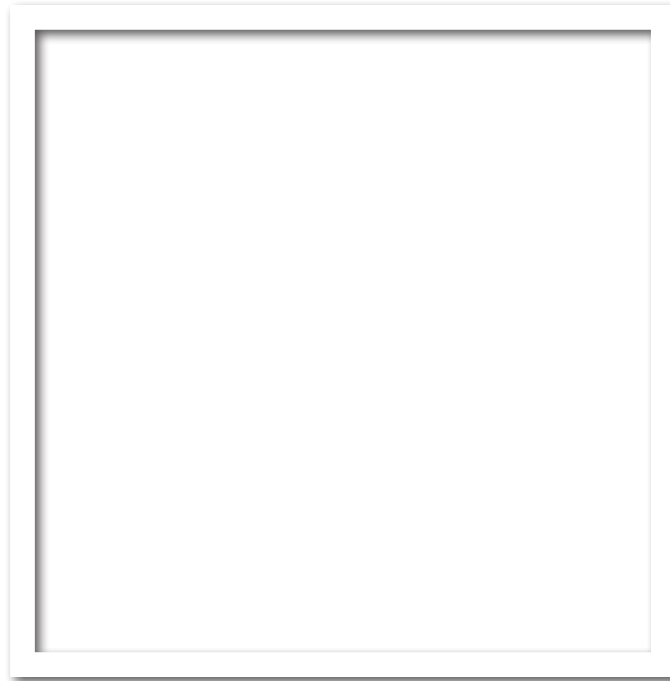

CMPA1D1E080F-AMP Demonstration Amplifier Circuit Schematic

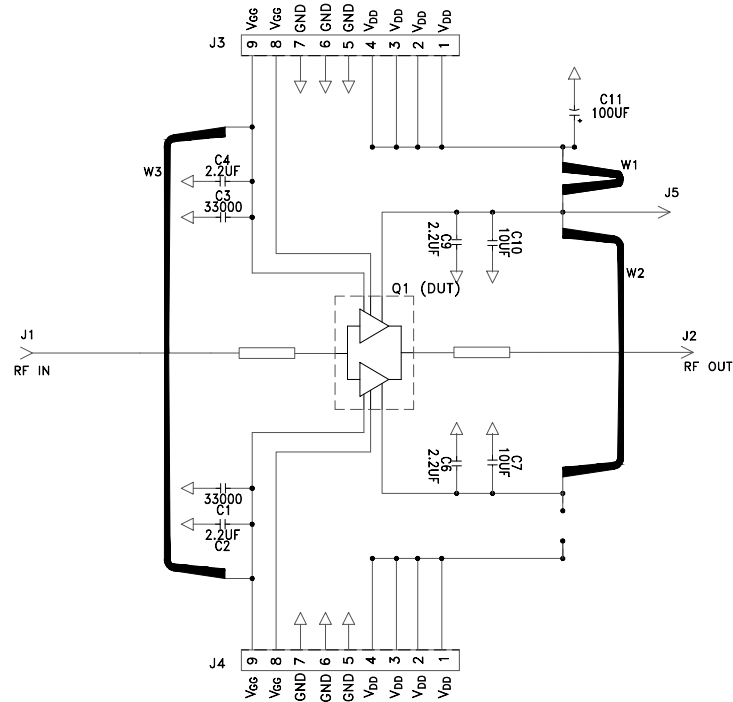

CMPA1D1E080F-AMP Demonstration Amplifier Circuit Outline

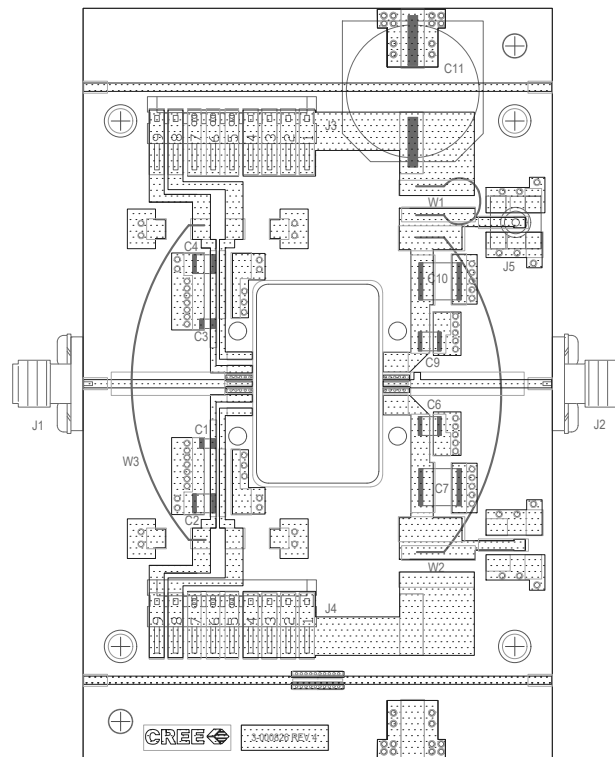

Product Dimensions CMPA1D1E080F (Package Type — 440222)

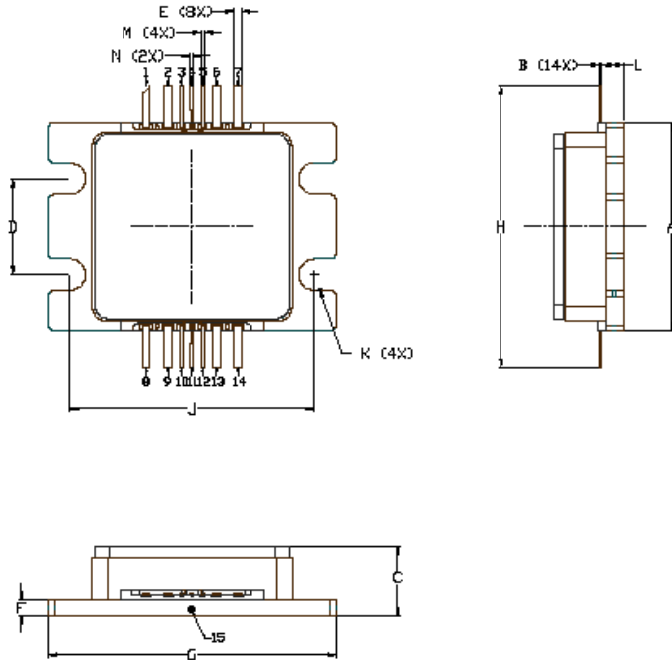

NOTES:

1. DIMENSIONING AND TOLERANCING PER ANSI Y14.5M, 1982
2. CONTROLLING DIMENSION: INCH.
3. ADHESIVE FROM LID MAY EXTEND A MAXIMUM OF 0.020" BEYOND EDGE OF LID.
4. LID MAY BE MISALIGNED TO THE BODY OF THE PACKAGE BY A MAXIMUM OF 0.008" IN ANY DIRECTION.
5. ALL PLATED SURFACES ARE Ni/AU.

DIM	INCHES		MILLIMETERS	
	MIN	MAX	MIN	MAX
A	0.878	0.891	17.25	17.55
B	0.003	0.006	0.076	0.152
C	0.214	0.241	5.44	6.12
D	0.307	0.323	7.80	8.20
E	0.016	0.032	0.406	0.813
F	0.047	0.063	1.194	1.600
G	0.936	0.854	23.77	24.23
H	0.912	0.930	23.16	23.62
J	0.795	0.811	20.19	20.60
K	Ø0.094	Ø0.110	Ø2.39	Ø2.79
L	0.062	0.078	1.575	1.981
M	0.006	0.022	0.152	0.559
N	0.004	0.018	0.102	0.457

Pin Number	Qty
1	NC
2	Gate 2 Bias
3	GND
4	RF In
5	GND
6	Gate 1 Bias
7	NC
8	Drain 2 Bias
9	Drain 2 Bias
10	GND
11	RF Out
12	GND
13	Drain 1 Bias
14	Drain 1 Bias

Electrostatic Discharge (ESD) Classifications

Parameter	Symbol	Class	Test Methodology
Human Body Model	HBM	1A (> 250 V)	JEDEC JESD22 A114-D
Charge Device Model	CDM	II (200 < 500 V)	JEDEC JESD22 C101-C

CMPA1D1E080F

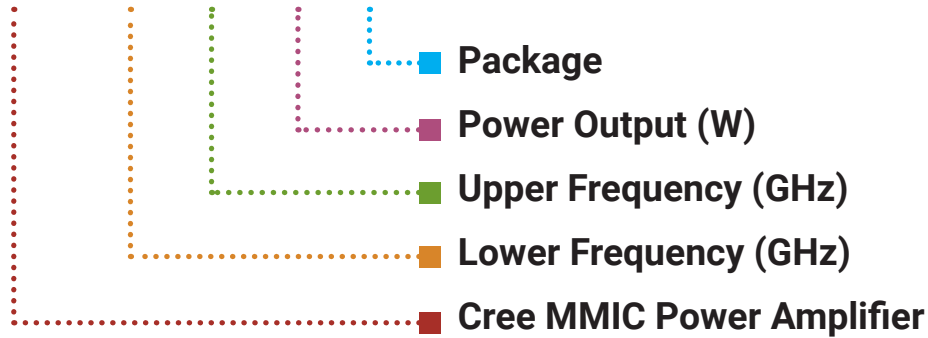

Parameter	Value	Units
Lower Frequency	13	GHz
Upper Frequency ¹	14	GHz
Power Output	80	W
Package	Flange	-

Table 1.

Note¹: Alpha characters used in frequency code indicate a value greater than 9.9 GHz. See Table 2 for value.

Character Code	Code Value
A	0
B	1
C	2
D	3
E	4
F	5
G	6
H	7
J	8
K	9
Examples:	1A = 10.0 GHz 2H = 27.0 GHz

Table 2.

Product Ordering Information

Order Number	Description	Unit of Measure	Image
CMPA1D1E080F	GaN HEMT	Each	
CMPA1D1E080F-AMP	Test board with GaN HEMT installed	Each	



Disclaimer

Specifications are subject to change without notice. Cree, Inc. believes the information contained within this data sheet to be accurate and reliable. However, no responsibility is assumed by Cree for its use or for any infringement of patents or other rights of third parties which may result from its use. No license is granted by implication or otherwise under any patent or patent rights of Cree. Cree makes no warranty, representation or guarantee regarding the suitability of its products for any particular purpose. "Typical" parameters are the average values expected by Cree in large quantities and are provided for information purposes only. These values can and do vary in different applications, and actual performance can vary over time. All operating parameters should be validated by customer's technical experts for each application. Cree products are not designed, intended, or authorized for use as components in applications intended for surgical implant into the body or to support or sustain life, in applications in which the failure of the Cree product could result in personal injury or death, or in applications for the planning, construction, maintenance or direct operation of a nuclear facility. CREE and the CREE logo are registered trademarks of Cree, Inc.

For more information, please contact:

Cree, Inc.
4600 Silicon Drive
Durham, North Carolina, USA 27703
www.cree.com/RF