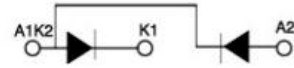
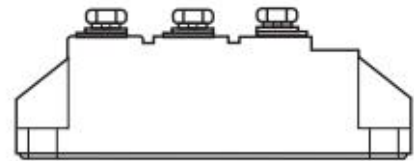

FEATURES

- Reduced RFI and EMI
- Reduced Snubbing
- Extensive Characterization of Recovery Parameters
- Minimum Lot-to-Lot variations for robust device performance and reliable operation

APPLICATIONS

- These devices are ideally suited for power converters, motors drives and other applications where switching losses are significant portion of the total losses.

ABSOLUTE MAXIMUM RATINGS

SYMBOL	PARAMETER	CONDITIONS	VALUE	UNIT
V_R	Repetitive Peak Reverse Voltage	$t_p=10ms$	1400	V
$I_{F(AV)}$	Average Forward Current	Single phase, half-wave 180° condition, $T_C=100^\circ C$	90	A
I_{FSM}	Surge Forward Current	10ms, Single phase, half-wave, $V_R=0.6V_{RRM}$	2.3	KA
I^2t	I^2t for fusing	10ms, Single phase, half-wave, $V_R=0.6V_{RRM}$	26.9×10^3	A^2S
V_{iso}	Isolated Voltage	50Hz	2500	V
T_J	Junction Temperature		-40~125	$^\circ C$
T_{stg}	Storage Temperature Range		-40~125	$^\circ C$

THERMAL CHARACTERISTICS

SYMBOL	PARAMETER	MAX	UNIT
$R_{th\ j-c}$	Thermal Resistance, Junction to Case	0.47	$^\circ C/W$

ELECTRICAL CHARACTERISTICS

SYMBOL	PARAMETER	CONDITIONS	MAX	UNIT
V _{FM}	Forward Voltage drop	I _F = 270A, T _J = 25°C	1.33	V
I _R	Instantaneous Reverse Current	V _R =V _{RRM} , T _J =150°C	8	mA

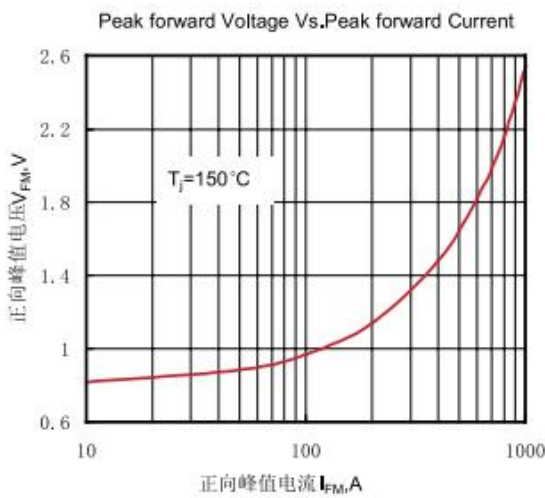

Fig.1 正向伏安特性曲线

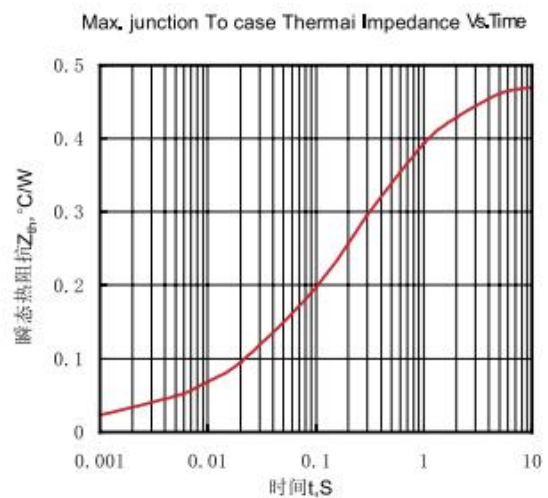

Fig.2 瞬态热阻抗曲线

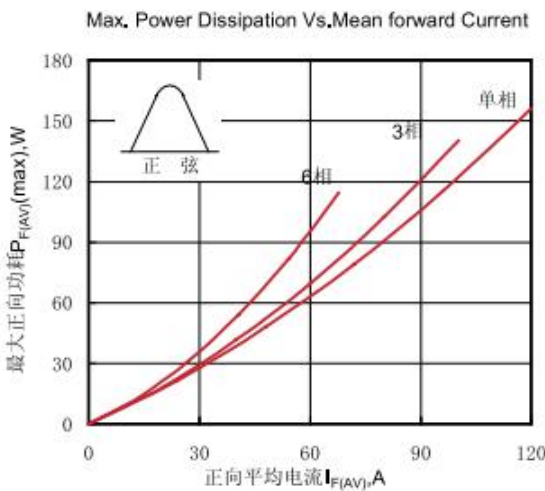

Fig.3最大正向功耗与平均电流的关系曲线

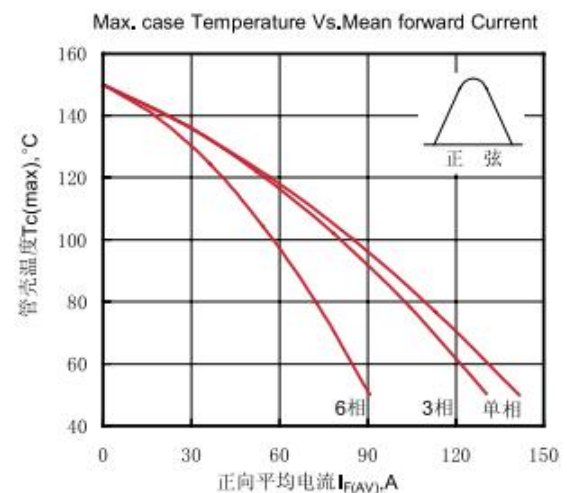

Fig.4管壳温度与正向平均电流的关系曲线

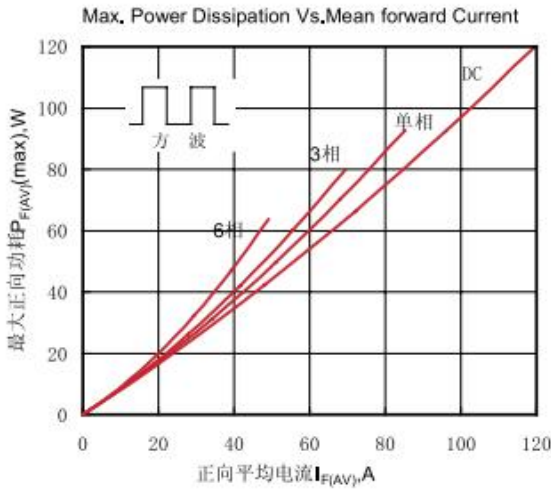

Fig.5最大正向功耗与平均电流的关系曲线

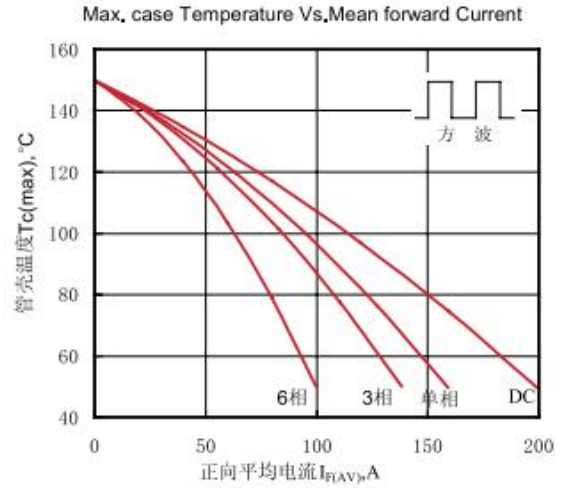

Fig.6管壳温度与正向平均电流的关系曲线

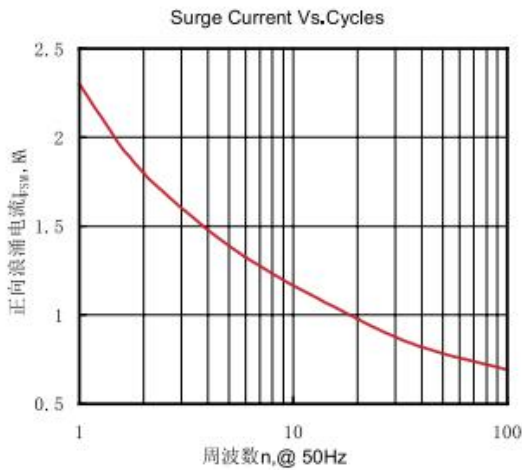

Fig.7 正向浪涌电流与周波数的关系曲线

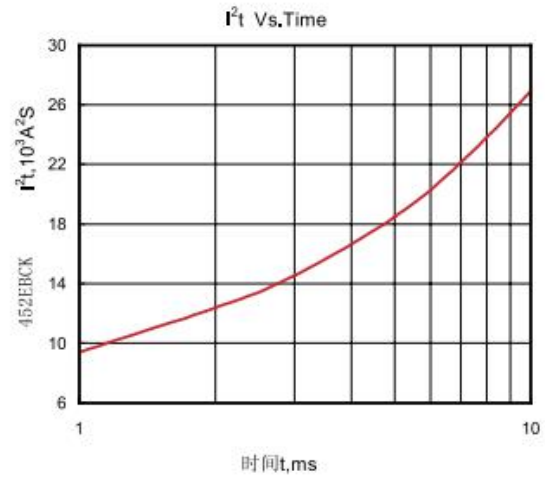
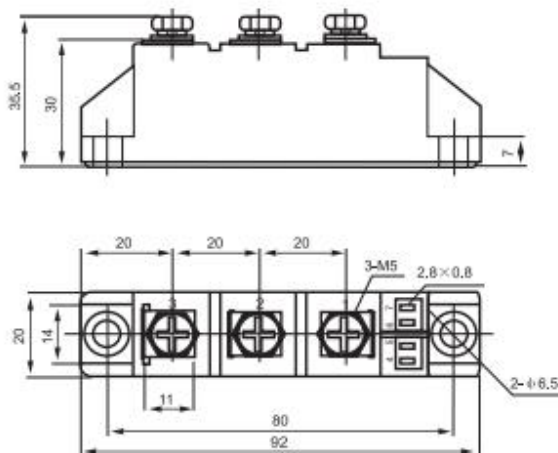

Fig.8 I²t特性曲线

PACKAGE OUTLINE

Dimensions in mm (1mm = 0.0394")



**NOTICE:**

ISC reserves the rights to make changes of the content herein the datasheet at any time without notification. The information contained herein is presented only as a guide for the applications of our products.

ISC products are intended for usage in general electronic equipment. The products are not designed for use in equipment which require specialized quality and/or reliability, or in equipment which could have applications in hazardous environments, aerospace industry, or medical field. Please contact us if you intend our products to be used in these special applications.

ISC makes no warranty or guarantee regarding the suitability of its products for any particular purpose, nor does ISC assume any liability arising from the application or use of any products, and specifically disclaims any and all liability, including without limitation special, consequential or incidental damages.