

TVS Surface Mount - 400W

Description

TVS diodes can be used in a wide range of applications which like consumer electronic products, automotive industries, munitions, telecommunications, aerospace industries, and intelligent control systems.

Features

- ※ Glass passivated or planar junction
- ※ Excellent clamping capability
- ※ Repetition rate (duty cycle): 0.01%
- ※ Low profile package and low inductance
- ※ 400W Peak Pulse power capability at 10×1000μs waveform.
- ※ Fast response time: typically less than 1.0ps from 0V to V_{BR} min.
- ※ High temperature soldering: 260°C/10s at terminals.
- ※ Plastic package has Underwriters Laboratory Flammability 94V-0.
- ※ For surface mounted applications in order to optimize board space.

Dimensions&Symbol (Unit:mmMax)



SMF/SOD-123FL

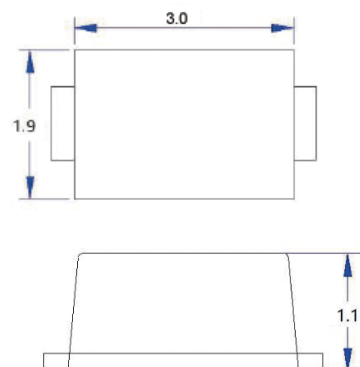
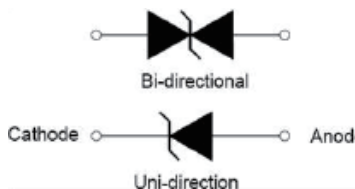

MechanicalCharacteristics

- ※ Package: SMF/SOD-123FL
- ※ Case Material: "Green" Molding Compound.
- ※ UL Flammability Classification Rating 94V-0
- ※ Polarity: Color band denotes cathode except bi-directional models
- ※ Weight: 0.017g
- ※ Terminal Connections: See Diagram Below

Main Applications

- ※ I/O Interface.
- ※ AC/DC Power supply
- ※ Low frequency signal transmission line (RS232, RS485, etc.)

TVS Surface Mount - 400W

Electrical Characteristics (T_A=25°C)

Part Number		Marking		V _R	I _R @V _R	V _{BR} @I _T		I _T	V _C @I _{PP}	I _{PP} ®
Uni-Polar	Bi-Polar	Uni	Bi	V	µA	min(V)	max(V)	mA	max(V)	A
P4SMFT3.3A	P4SMFT3.3CA	EHD	ETD	3.3	400	4.10	4.75	10	7.3	54.7
P4SMFT5.0A	P4SMFT5.0CA	EHE	ETE	5.0	400	6.40	7.00	10	9.2	43.5
P4SMFT6.0A	P4SMFT6.0CA	EHG	ETG	6.0	400	6.67	7.37	10	10.3	38.8
P4SMFT6.5A	P4SMFT6.5CA	EHK	ETK	6.5	400	7.22	7.98	10	11.2	35.7
P4SMFT7.0 A	P4SMFT7.0CA	EHM	ETM	7.0	250	7.78	8.60	10	12.0	33.3
P4SMFT7.5A	P4SMFT7.5CA	EHP	ETP	7.5	100	8.33	9.21	10	12.9	31.0
P4SMFT8.0A	P4SMFT8.0CA	EHR	ETR	8.0	50	8.89	9.83	1	13.6	29.4
P4SMFT8.5 A	P4SMFT8.5CA	EHT	ETT	8.5	25	9.44	10.4	1	14.4	27.8
P4SMFT9.0 A	P4SMFT9.0CA	EHV	ETV	9.0	10	10.0	11.1	1	15.4	26.0
P4SMFT10A	P4SMFT10CA	EHX	ETX	10.0	5	11.1	12.3	1	17.0	23.5
P4SMFT11A	P4SMFT11CA	EHZ	ETZ	11.0	2.5	12.2	13.5	1	18.2	22.0
P4SMFT12A	P4SMFT12CA	EIE	EUE	12.0	2.5	13.3	14.7	1	19.9	20.1
P4SMFT13A	P4SMFT13CA	EIG	EUG	13.0	2.5	14.4	15.9	1	21.5	18.6
P4SMFT14A	P4SMFT14CA	EIK	EUK	14.0	1	15.6	17.2	1	23.2	17.2
P4SMFT15A	P4SMFT15CA	EIM	EUM	15.0	1	16.7	18.5	1	24.4	16.4
P4SMFT16A	P4SMFT16CA	EIP	EUP	16.0	1	17.8	19.7	1	26.0	15.4
P4SMFT17A	P4SMFT17CA	EIR	EUR	17.0	1	18.9	20.9	1	27.6	14.5
P4SMFT18A	P4SMFT18CA	EIT	EUT	18.0	1	20.0	22.1	1	29.2	13.7
P4SMFT20A	P4SMFT20CA	EIV	EUV	20.0	1	22.2	24.5	1	32.4	12.3
P4SMFT22A	P4SMFT22CA	EIX	EUX	22.0	1	24.4	26.9	1	35.5	11.3
P4SMFT24A	P4SMFT24CA	EIZ	EUZ	24.0	1	26.7	29.5	1	38.9	10.3
P4SMFT26A	P4SMFT26CA	EJE	EVE	26.0	1	28.9	31.9	1	42.1	9.5
P4SMFT28A	P4SMFT28CA	EJG	EVG	28.0	1	31.1	34.4	1	45.4	8.8
P4SMFT30A	P4SMFT30CA	EJK	EVK	30.0	1	33.3	36.8	1	48.4	8.3
P4SMFT33A	P4SMFT33CA	EJM	EVM	33.0	1	36.7	40.6	1	53.3	7.5
P4SMFT36A	P4SMFT36CA	EJP	EVP	36.0	1	40.0	44.2	1	58.1	6.9
P4SMFT40A	P4SMFT40CA	EJR	EVR	40.0	1	44.4	49.1	1	64.5	6.2
P4SMFT43A	P4SMFT43CA	EJT	EVT	43.0	1	47.8	52.8	1	69.4	5.8
P4SMFT45A	P4SMFT45CA	EJV	EVV	45.0	1	50.0	55.3	1	72.7	5.5
P4SMFT48A	P4SMFT48CA	EJX	EVX	48.0	1	53.3	58.9	1	77.4	5.2

TVS Surface Mount - 400W
Electrical Characteristics ($T_A=25^{\circ}\text{C}$)

Part Number		Marking		V_R	$I_R@V_R$	$V_{BR}@I_T$		I_T	$V_C@I_{PP}$	I_{PP}
Uni-Polar	Bi-Polar	Uni	Bi	V	μA	min(V)	max(V)	mA	max(V)	A
P4SMFT51A	P4SMFT51CA	EJZ	EVZ	51.0	1	56.7	62.7	1	82.4	4.9
P4SMFT54A	P4SMFT54CA	ERE	EWE	54.0	1	60.0	66.3	1	87.1	4.6
P4SMFT58A	P4SMFT58CA	ERG	EWG	58.0	1	64.4	71.2	1	93.6	4.3

① Surge waveform: 10/1000 μs

V_R : Stand-off Voltage -- Maximum voltage that can be applied

V_{BR} : Breakdown Voltage

V_C : Clamping Voltage -- Peak voltage measured across the suppressor at a specified I_{PP}

I_R : Reverse Leakage Current

Absolute maximum ratings ($T_A=25^{\circ}\text{C}$, RH=45%-75%, unless otherwise noted)

Parameter	Symbol	Value	Unit
Storage temperature range	T_{stg}	-55 to +150	$^{\circ}\text{C}$
Operating junction temperature range	T_j	-55 to +150	$^{\circ}\text{C}$
Peak pulse power dissipation on 10/1000 μs waveform	P_{PP}	400	W
Maximum Instantaneous Forward Voltage at 30A for Unidirectional	V_F	6.5	V

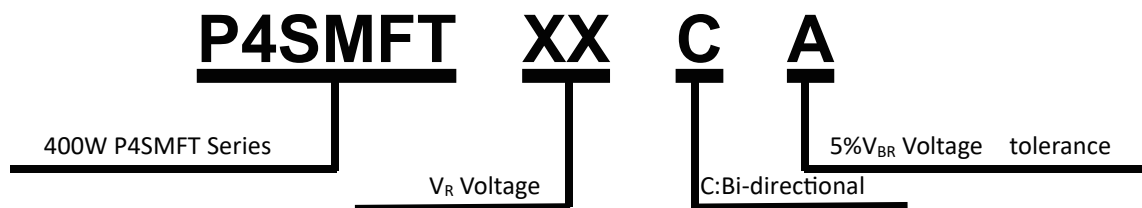
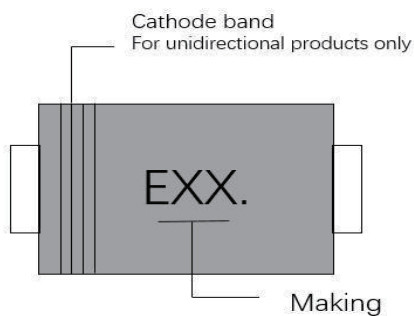
Part Number Code

Marking Information

Ordering Information

Out line	Reel (pcs)	Reel diameters
Taping	3K	7inch

TVS Surface Mount - 400W

Ratings and V-I characteristics curves ($T_A=25^\circ\text{C}$, unless otherwise noted)

FIG.1:V- I curve characteristics (Uni-directional)

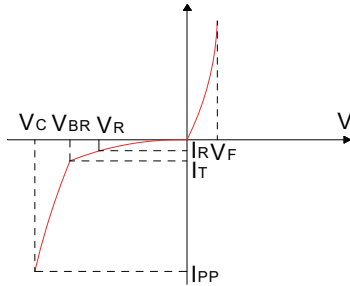
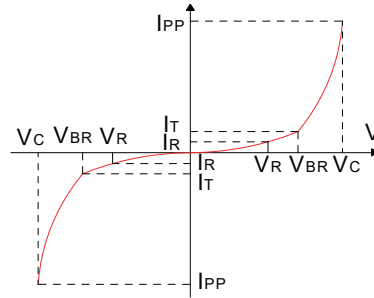

FIG.2:V- I curve characteristics (Bi-directional)



Typical Characteristics

Figure 1: Peak Pulse Power Rating Curve

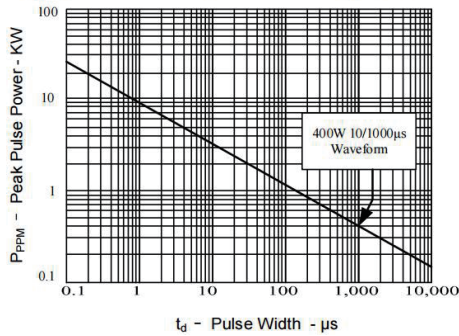

Figure 2: Pulse Derating Curve

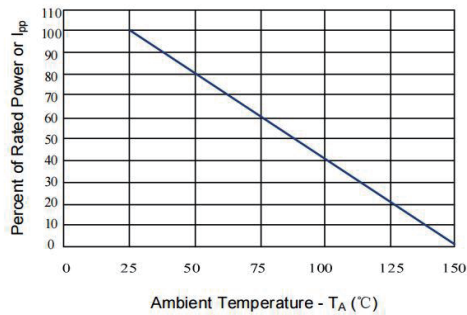

Figure 3: Pulse Waveform

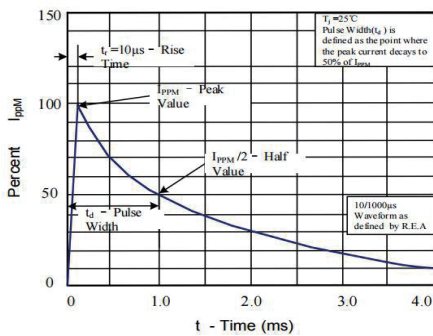

Figure 4: Typical Junction Capacitance

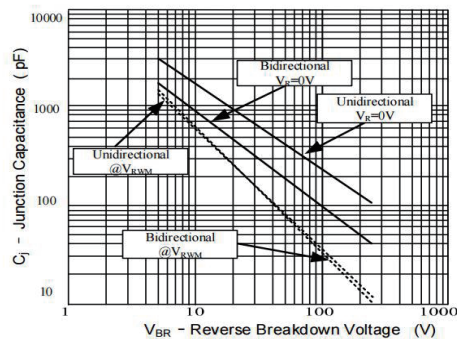

Figure 5: Steady State Power Dissipation Derating Curve

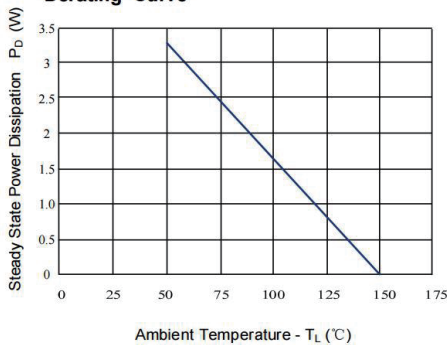
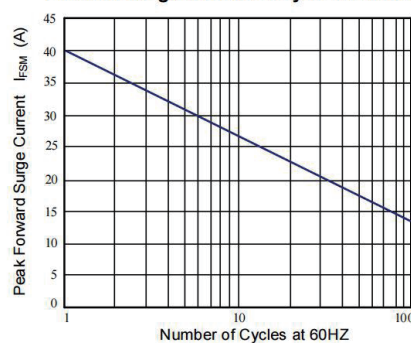

Figure 6: Maximum Non-Repetitive Forward Surge Current Only Unidirectional



TVS Surface Mount - 400W

Soldering Parameters

Reflow Condition		Pb-Free assembly (see as bellow)
Pre Heat	-Temperature Min ($T_{s(min)}$)	+150°C
	-Temperature Max($T_{s(max)}$)	+200°C
	-Time (Min to Max) (t_s)	60-180 secs.
Average ramp up rate (Liquid us Temp (T_L) to peak)		3°C/sec. Max
$T_{s(max)}$ to T_L - Ramp-up Rate		3°C/sec. Max
Reflow	-Temperature(T_L)(Liquid us)	+217°C
	-Temperature(t_L)	60-150 secs.
Peak Temp (T_P)		+260(+0/-5)°C
Time within 5°C of actual Peak Temp (t_p)		30 secs. Max
Ramp-down Rate		6°C/sec. Max
Time 25°C to Peak Temp (T_P)		8 min. Max
Do not exceed		+260°C

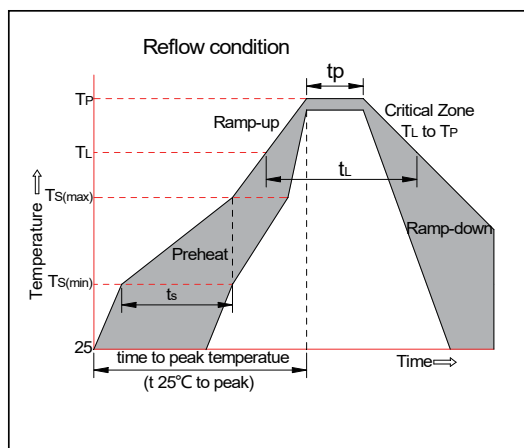

Package Mechanical Data

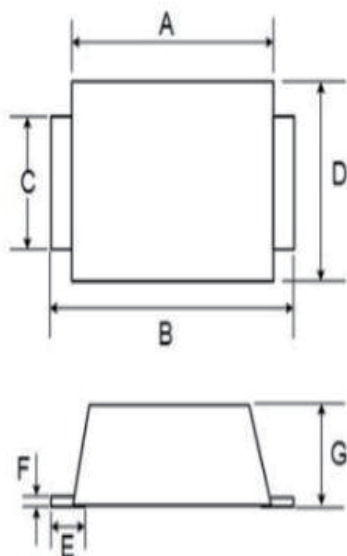

Dimension	Millimeters	
	Min	Max
A	2.5	3.0
B	3.4	4.0
C	0.7	1.1
D	1.5	1.9
E	0.45	0.95
F	0.05	0.26
G	0.8	1.1

TVS Surface Mount - 400W

Please Read Carefully

Information in this document is provided solely in connection with UMD products. UMD reserves the right to make changes, corrections, modifications or improvements, to this document, and the products and services described herein at any time, without notice.

All UMD products are sold pursuant to UMD's terms and conditions of sale.

Purchasers are solely responsible for the choice, selection and use of the UMD products and services described herein, and UMD assumes no liability whatsoever relating to the choice, selection or use of the UMD products and services described herein.

No license, express or implied, by estoppels or otherwise, to any intellectual property rights is granted under this document. If any part of this document refers to any third party products or services it shall not be deemed a license grant by UMD for the use of such third party products or services, or any intellectual property contained therein or considered as a warranty covering the use in any manner whatsoever of such third party products or services or any intellectual property contained therein.

Unless otherwise set forth in UMD's Terms and Conditions of sale UMD disclaims any express or implied warranty with respect to the use and/or sale of UMD products including without limitation implied warranties of merchantability, fitness for a particular purpose (and their equivalents under the laws of any jurisdiction), or infringement of any patent, copyright or other intellectual property right.

Unless expressly approved in writing by an authorized UMD representative, UMD products are not recommended, authorized or warranted for use in military, air craft, space, life saving, or life sustaining applications, nor in products or systems where failure or malfunction may result in personal injury, death, or severe property or environmental damage. Resale of UMD products with provisions different from the statements and/or technical features set forth in this document shall immediately void any warranty granted by UMD for the UMD product or service described herein and shall not create or extend in any manner whatsoever, any liability of UMD.

2010 United Micro Device Inc – All rights reserved

www.umdcorp.com