

## LMC6572/LMC6574 Dual and Quad Low Voltage (2.7V and 3V) Operational Amplifier

 Check for Samples: [LMC6572](#), [LMC6574](#)

### FEATURES

- (Typical unless otherwise noted)
- Guaranteed 2.7V and 3V Performance
- Rail-to-Rail Output Swing (within 5 mV of supply rail, 100 k $\Omega$  load)
- Ultra-Low Supply Current: 40  $\mu$ A/Amplifier
- Low Cost
- Ultra-Low Input Current: 20 fA
- High Voltage Gain @  $V_S=2.7V$ ,  $R_L=100$  k $\Omega$ : 120 dB
- Specified for 100 k $\Omega$  and 5 k $\Omega$  loads

- Available in MSOP Package

### APPLICATIONS

- Transducer Amplifier
- Portable or Remote Equipment
- Battery-Operated Instruments
- Data Acquisition Systems
- Medical Instrumentation
- Improved Replacement for TLV2322 and TLV2324

### DESCRIPTION

Low voltage operation and low power dissipation make the LMC6574/2 ideal for battery-powered systems.

3V amplifier performance is backed by 2.7V guarantees to ensure operation throughout battery lifetime. These guarantees also enable analog circuits to operate from the same 3.3V supply used for digital logic.

Battery life is maximized because each amplifier dissipates only micro-watts of power.

The LMC6574/2 does not sacrifice functionality for low voltage operation. The LMC6574/2 generates 120 dB of open-loop gain just like a conventional amplifier, but the LMC6574/2 can do this from a 2.7V supply.

These amplifiers are designed with features that optimize low voltage operation. The output voltage swings rail-to-rail to maximize signal-to-noise ratio and dynamic signal range. The common-mode input voltage range extends from 800 mV below the positive supply to 100 mV below ground.

This device is built with National's advanced Double-Poly Silicon-Gate CMOS process.

LMC6572 is also available in MSOP package which is almost half the size of a SO-8 device.

### Connection Diagram

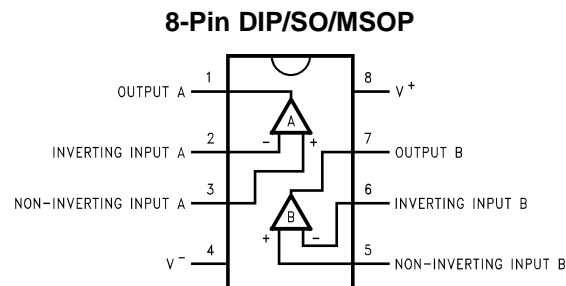
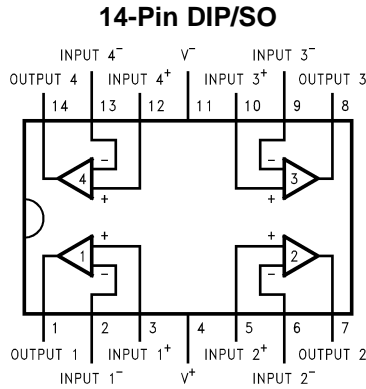

**Figure 1. Order Number LMC6572AIN, LMC6572BIN, LMC6572AIM, LMC6572AIMX, LMC6572BIM, LMC6572BIMX, LMC6572BIMM or LMC6572BIMMX  
See NS Package Number N08E, M08A or MUA08A**



Please be aware that an important notice concerning availability, standard warranty, and use in critical applications of Texas Instruments semiconductor products and disclaimers thereto appears at the end of this data sheet.

All trademarks are the property of their respective owners.



**Figure 2. Order Number LMC6574AIN, LMC6574BIN, LMC6574AIM, LMC6574AIMX, LMC6574BIM or LMC6574BIMX  
See NS Package Number N14A or M14A**



These devices have limited built-in ESD protection. The leads should be shorted together or the device placed in conductive foam during storage or handling to prevent electrostatic damage to the MOS gates.

**Absolute Maximum Ratings <sup>(1)</sup>**

ESD Tolerance <sup>(2)</sup>	2000V
Differential Input Voltage	±Supply Voltage
Voltage at Input/Output Pin	(V <sup>+</sup> ) +0.3V, (V <sup>-</sup> ) -0.3V
Supply Voltage (V <sup>+</sup> - V <sup>-</sup> )	12V
Current at Input Pin	±5 mA
Current at Output Pin <sup>(3)</sup>	±10 mA
Current at Power Supply Pin	35 mA
Lead Temperature	
(Soldering, 10 Seconds)	260°C
Storage Temperature Range	-65°C to +150°C
Junction Temperature <sup>(4)</sup>	150°C

- (1) Absolute Maximum Ratings indicate limits beyond which damage to the device may occur. Operating Ratings indicate conditions for which the device is intended to be functional, but specific performance is not guaranteed. For guaranteed specifications and test conditions, see the Electrical Characteristics.
- (2) Human body model, 1.5 kΩ in series with 100 pF.
- (3) Applies to both single-supply and split-supply operation. Continuous short circuit operation at elevated ambient temperature can result in exceeding the maximum allowed junction temperature of 150°C.
- (4) The maximum power dissipation is a function of T<sub>J(Max)</sub>, θ<sub>JA</sub>, and T<sub>A</sub>. The maximum allowable power dissipation at any ambient temperature is P<sub>D</sub> = (T<sub>J(Max)</sub> - T<sub>A</sub>)/θ<sub>JA</sub>. All numbers apply for packages soldered directly into a PC board.

**Operating Ratings <sup>(1)</sup>**

Supply Voltage	2.7V ≤ V <sup>+</sup> ≤ 11V
Junction Temperature Range	
LMC6572AI, LMC6572BI	-40°C ≤ T <sub>J</sub> ≤ +85°C
LMC6574AI, LMC6574BI	-40°C ≤ T <sub>J</sub> ≤ +85°C
Thermal Resistance (θ <sub>JA</sub> )	
N Package, 8-Pin Molded DIP	115°C/W
M Package, 8-Pin Surface Mount	193°C/W
MSOP Package, 8-Pin Mini SO	217°C/W

- (1) Absolute Maximum Ratings indicate limits beyond which damage to the device may occur. Operating Ratings indicate conditions for which the device is intended to be functional, but specific performance is not guaranteed. For guaranteed specifications and test conditions, see the Electrical Characteristics.

**Operating Ratings <sup>(1)</sup> (continued)**

N Package, 14-Pin Molded DIP	81°C/W
M Package, 14-Pin Surface Mount	126°C/W

## 2.7V DC Electrical Characteristics

Unless otherwise specified, all limits guaranteed for  $T_J = 25^\circ\text{C}$ .  $V^+ = 2.7\text{V}$ ,  $V^- = 0\text{V}$ ,  $V_{\text{CM}} = V_O = V^+/2$  and  $R_L > 1\text{M}\Omega$ . **Boldface** limits apply at the temperature extremes.

Symbol	Parameter	Conditions		Typ (1)	LMC6574AI	LMC6574BI	Units
					LMC6572AI	LMC6572BI	
					Limit	Limit	
					(2)	(2)	
$V_{\text{OS}}$	Input Offset Voltage	$V^+ = 2.7\text{V}$ and $3\text{V}$		0.5	3	7	mV
					<b>3.5</b>	<b>7.5</b>	Max
$\text{TCV}_{\text{OS}}$	Input Offset Voltage			1.5			$\mu\text{V}/^\circ\text{C}$
	Average Drift						
$I_B$	Input Current			0.02			pA
					<b>10</b>	<b>10</b>	Max
$I_{\text{OS}}$	Input Offset Current			0.01			pA
					<b>6</b>	<b>6</b>	Max
$R_{\text{IN}}$	Input Resistance			>1			Tera $\Omega$
$C_{\text{IN}}$	Common-Mode			3			pF
	Input Capacitance						
CMRR	Common Mode	$0\text{V} \leq V_{\text{CM}} \leq 3.5\text{V}$		75	63	60	dB
	Rejection Ratio	$V^+ = 5\text{V}$			<b>60</b>	<b>57</b>	Min
+PSRR	Positive Power Supply	$2.7\text{V} \leq V^+ \leq 5\text{V}$ ,		75	67	60	dB
	Rejection Ratio	$V^- = 0\text{V}$			<b>65</b>	<b>58</b>	Min
-PSRR	Negative Power Supply	$-2.7\text{V} \leq V^- \leq -5\text{V}$ ,		83	75	67	dB
	Rejection Ratio	$V^+ = 0\text{V}$			<b>73</b>	<b>65</b>	Min
$V_{\text{CM}}$	Input Common-Mode	$V^+ = 2.7\text{V}$ and $3\text{V}$		-0.1	-0.05	-0.05	V
	Voltage Range	for CMRR $\geq 50$ dB			<b>0</b>	<b>0</b>	Max
				$V^+ - 0.8$	$V^+ - 1.0$	$V^+ - 1.0$	V
$A_V$	Large Signal	$R_L = 100\text{ k}\Omega$	Sourcing	1000			V/mV
			Voltage Gain	(3)			
				Sinking	500		
$V_O$	Output Swing	$V^+ = 2.7\text{V}$		2.695	2.68	2.65	V
		$R_L = 100\text{ k}\Omega$ to $V^+/2$			<b>2.66</b>	<b>2.62</b>	Min
				0.005	0.03	0.06	V
					<b>0.05</b>	<b>0.09</b>	Max
		$V^+ = 2.7\text{V}$		2.66	2.55	2.45	V
		$R_L = 5\text{ k}\Omega$ to $V^+/2$			<b>2.45</b>	<b>2.35</b>	Min
				0.04	0.15	0.25	V
					<b>0.25</b>	<b>0.35</b>	Max
		$V^+ = 3\text{V}$		2.995	2.98	2.95	V
		$R_L = 100\text{ k}\Omega$ to $V^+/2$			<b>2.96</b>	<b>2.93</b>	Min
				0.005	0.03	0.06	V
					<b>0.05</b>	<b>0.09</b>	Max
		$V^+ = 3\text{V}$		2.96	2.85	2.75	V
		$R_L = 5\text{ k}\Omega$ to $V^+/2$			<b>2.75</b>	<b>2.65</b>	Min
			0.04	0.15	0.25	V	
				<b>0.25</b>	<b>0.35</b>	Max	

(1) Typical values represent the most likely parametric norm.

(2) All limits are guaranteed by testing or statistical analysis.

(3)  $V^+ = 3\text{V}$ ,  $V_{\text{CM}} = 1.5\text{V}$  and  $R_L$  connected to  $1.5\text{V}$ . For Sourcing tests,  $1.5\text{V} \leq V_O \leq 2.5\text{V}$ . For Sinking tests,  $0.5\text{V} \leq V_O \leq 1.5\text{V}$ .

## 2.7V DC Electrical Characteristics (continued)

Unless otherwise specified, all limits guaranteed for  $T_J = 25^\circ\text{C}$ .  $V^+ = 2.7\text{V}$ ,  $V^- = 0\text{V}$ ,  $V_{\text{CM}} = V_O = V^+/2$  and  $R_L > 1\text{M}\Omega$ . **Boldface** limits apply at the temperature extremes.

Symbol	Parameter	Conditions	Typ (1)	LMC6574AI	LMC6574BI	Units
				LMC6572AI	LMC6572BI	
				Limit	Limit	
				(2)	(2)	
$I_{\text{SC}}$	Output Short	Sourcing, $V_O = 0\text{V}$	6.0	4.0	3.0	mA
	Circuit Current			<b>3.0</b>	<b>2.0</b>	Min
		Sinking, $V_O = 2.7\text{V}$	4.0	3.0	2.5	mA
				<b>2.0</b>	<b>1.5</b>	Min
$I_S$	Supply Current	Quad Package	160	240	240	$\mu\text{A}$
		$V^+ = +2.7\text{V}$ , $V_O = V^+/2$		<b>280</b>	<b>280</b>	Max
		Quad Package	160	240	240	$\mu\text{A}$
		$V^+ = +3\text{V}$ , $V_O = V^+/2$		<b>280</b>	<b>280</b>	Max
		Dual Package	80	120	120	$\mu\text{A}$
		$V^+ = +2.7\text{V}$ , $V_O = V^+/2$		<b>140</b>	<b>140</b>	Max
	Dual Package	80	120	120	$\mu\text{A}$	
	$V^+ = +3\text{V}$ , $V_O = V^+/2$		<b>140</b>	<b>140</b>	Max	

### 2.7V AC Electrical Characteristics

Unless otherwise specified, all limits guaranteed for  $T_J = 25^\circ\text{C}$ ,  $V^+ = 2.7\text{V}$ ,  $V^- = 0\text{V}$ ,  $V_{CM} = V_O = V^+/2$  and  $R_L > 1\text{M}\Omega$ . **Boldface** limits apply at the temperature extremes.

Symbol	Parameter	Conditions	Typ (1)	LMC6574AI	LMC6574BI	Units
				LMC6572AI	LMC6572BI	
				Limit	Limit	
				(2)	(2)	
SR	Slew Rate	$V^+ = 2.7\text{V}$ and $3\text{V}$	90	30	30	V/ms
		(3)		<b>10</b>	<b>10</b>	Min
GBW	Gain-Bandwidth Product	$V^+ = 3\text{V}$	0.22			MHz
$\Phi_m$	Phase Margin		60			Deg
$G_m$	Gain Margin		12			dB
	Amp-to-Amp Isolation	(4)	120			dB
$e_n$	Input-Referred	$F = 1\text{ kHz}$	45			$\text{nV}/\sqrt{\text{Hz}}$
	Voltage Noise	$V_{CM} = 1\text{V}$				
$i_n$	Input-Referred	$F = 1\text{ kHz}$	0.002			$\text{pA}/\sqrt{\text{Hz}}$
	Current Noise					
T.H.D.	Total Harmonic Distortion	$F = 10\text{ kHz}$ , $A_V = -2$	0.05			%
		$R_L = 10\text{ k}\Omega$ , $V_O = 1.0\text{ V}_{PP}$				

- (1) Typical values represent the most likely parametric norm.
- (2) All limits are guaranteed by testing or statistical analysis.
- (3) Connected as Voltage Follower with 1.0V step input. Number specified is the slower of the positive and negative slew rates.
- (4) Input referred,  $V^+ = 3\text{V}$  and  $R_L = 100\text{ k}\Omega$  connected to 1.5V. Each amp excited in turn with 1 KHz to produce  $V_O = 2\text{ V}_{PP}$ .

### Typical Performance Characteristics

$V_S = +3V$ ,  $T_A = 25^\circ C$ , Unless otherwise specified

**Supply Current vs Supply Voltage (Dual Package)**

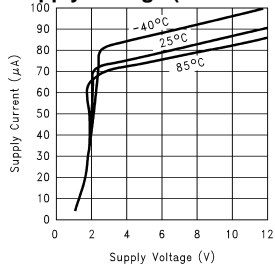

**Input Current vs Temperature**

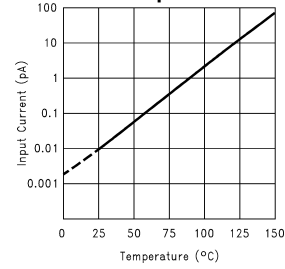

**Sourcing Current vs Output Voltage**

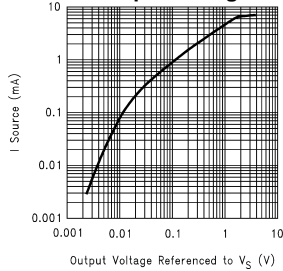

**Sinking Current vs Output Voltage**

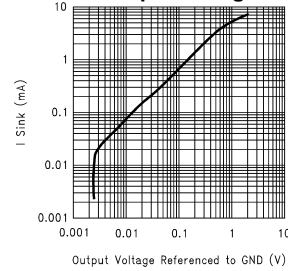

**Output Voltage Swing vs Supply Voltage**

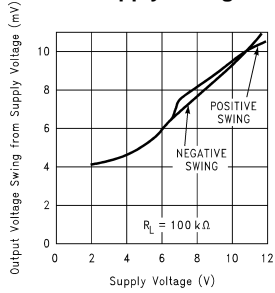

**Input Voltage Noise vs Frequency**

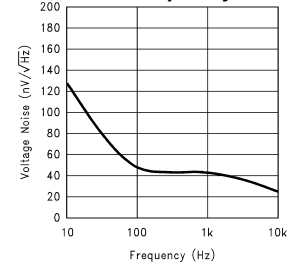

**Crosstalk Rejection vs Frequency**

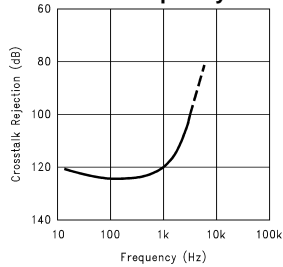

**Positive PSRR vs Frequency**

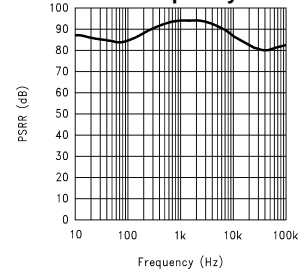

**Negative PSRR vs Frequency**

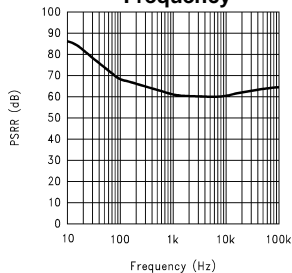

**CMRR**

**vs Frequency**

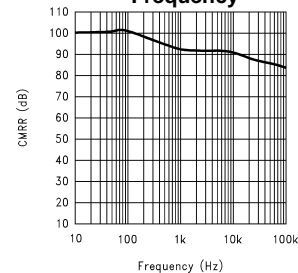

**Typical Performance Characteristics (continued)**

$V_S = +3V$ ,  $T_A = 25^\circ C$ , Unless otherwise specified

**Input Voltage vs Output Voltage ( $V_S = \pm 1.5$ )**

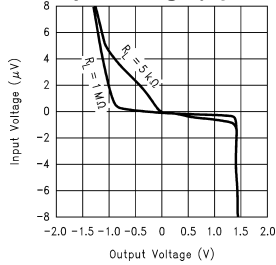

**Open Loop Frequency Response**

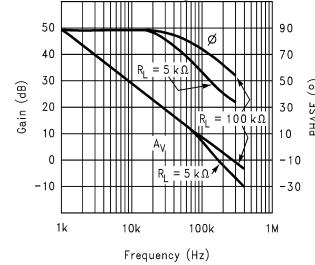

**Open Loop Frequency Response vs Temperature**

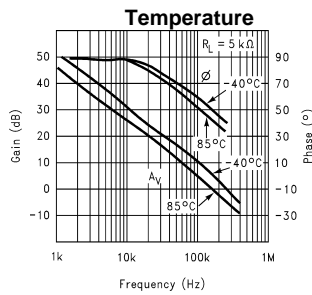

**Maximum Output Swing vs Frequency**

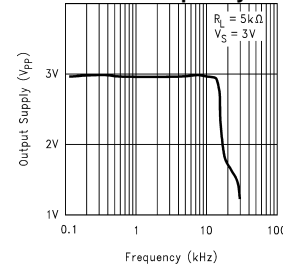

**ZOUT vs Frequency**

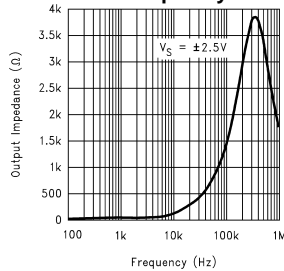

**Slew Rate vs Supply Voltage**

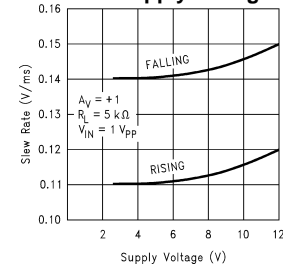

**Non-Inverting Large Signal Pulse Response**

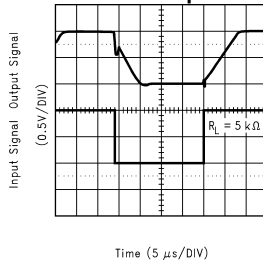

**Non-Inverting Small Signal Pulse Response**

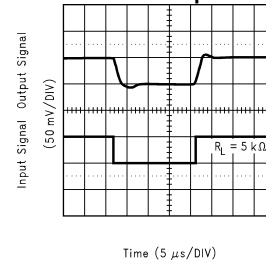

**Inverting Large Signal Pulse Response**

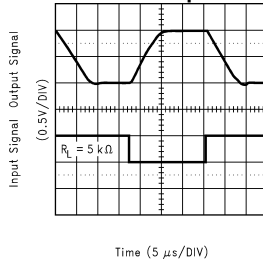

**Inverting Small Signal Pulse Response**

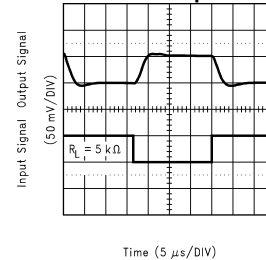



Typical Performance Characteristics (continued)

$V_S = +3V$ ,  $T_A = 25^\circ C$ , Unless otherwise specified

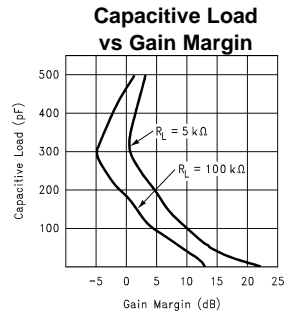
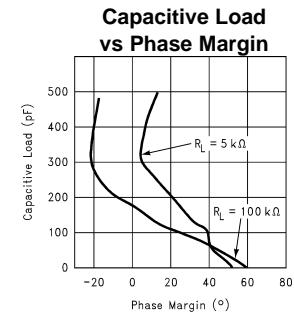
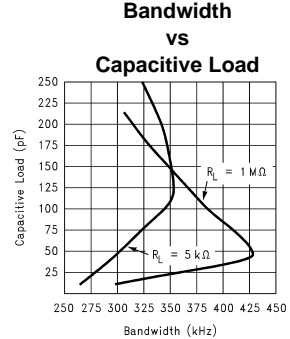
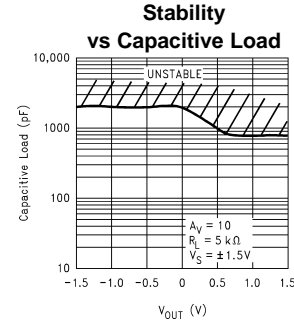
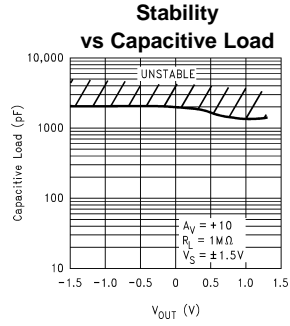
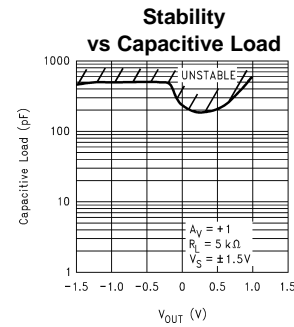
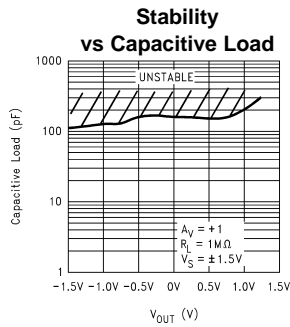

Applications Hints

LOW VOLTAGE AMPLIFIER TOPOLOGY

The LMC6574/2 incorporates a novel op-amp design topology that enables it to maintain rail-to-rail output swing even when driving a large load. Instead of relying on a push-pull unity gain output buffer stage, the output stage is taken directly from the internal integrator, which provides both low output impedance and large gain. Special feed-forward compensation design techniques are incorporated to maintain stability over a wider range of operating conditions than traditional micropower op-amps. These features make the LMC6574/2 both easier to design with, and provide higher speed than products typically found in this ultra-low power class.

**COMPENSATING FOR INPUT CAPACITANCE**

It is quite common to use large values of feedback resistance for amplifiers with ultra-low input current, like the LMC6574/2.

Although the LMC6574/2 is highly stable over a wide range of operating conditions, a large feedback resistor will react even with small values of capacitance at the input of the op-amp to reduce phase margin. The capacitance at the input of the op-amp comes from transducers, photodiodes and circuit board parasitics.

The effect of input capacitance can be compensated for by adding a capacitor,  $C_f$ , around the feedback resistors (as in Figure 3) such that:

$$\frac{1}{2\pi R_1 C_{IN}} \geq \frac{1}{2\pi R_2 C_f} \tag{1}$$

or

$$R_1 C_{IN} \leq R_2 C_f \tag{2}$$

Since it is often difficult to know the exact value of  $C_{IN}$ ,  $C_f$  can be experimentally adjusted so that the desired pulse response is achieved. Refer to the LMC660 and LMC662 for a more detailed discussion on compensating for input capacitance.

When high input impedances are demanded, guarding of the LMC6574/2 is suggested. Guarding input lines will not only reduce leakage, but lowers stray input capacitance as well. (See *Printed-Circuit-Board Layout for High Impedance Work*).

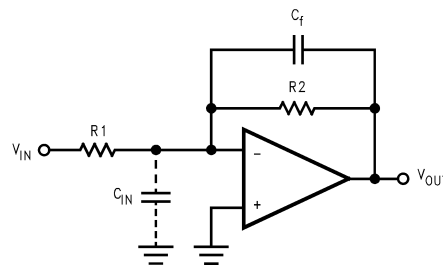

**Figure 3. Cancelling the Effect of Input Capacitance**

**CAPACITIVE LOAD TOLERANCE**

Direct capacitive loading will reduce the phase margin of many op-amps. A pole in the feedback loop is created by the combination of the op-amp's output impedance and the capacitive load. This pole induces phase lag at the unity-gain crossover frequency of the amplifier resulting in either an oscillatory or underdamped pulse response. With a few external components, op amps can easily indirectly drive capacitive loads, as shown in Figure 4.

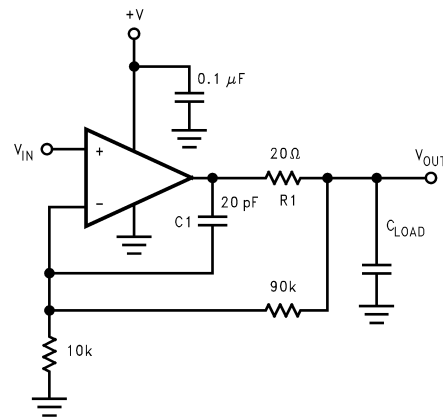

**Figure 4. LMC6574/2 Noninverting Gain of 10 Amplifier, Compensated to Handle Capacitive Loads**

In the circuit of [Figure 4](#), R1 and C1 serve to counteract the loss of phase margin by feeding the high frequency component of the output signal back to the amplifier's inverting input, thereby preserving phase margin in the overall feedback loop.

### PRINTED-CIRCUIT-BOARD LAYOUT FOR HIGH-IMPEDANCE WORK

It is generally recognized that any circuit which must operate with less than 1000 pA of leakage current requires special layout of the PC board. When one wishes to take advantage of the ultra-low bias current of the LMC6574/2, typically less than 20 fA, it is essential to have an excellent layout. Fortunately, the techniques of obtaining low leakages are quite simple. First, the user must not ignore the surface leakage of the PC board, even though it may sometimes appear acceptably low, because under conditions of high humidity or dust or contamination, the surface leakage will be appreciable.

To minimize the effect of any surface leakage, lay out a ring of foil completely surrounding the LMC6574/2's inputs and the terminals of capacitors, diodes, conductors, resistors, relay terminals, etc. connected to the op-amp's inputs, as in [Figure 5](#). To have a significant effect, guard rings should be placed on both the top and bottom of the PC board. This PC foil must then be connected to a voltage which is at the same voltage as the amplifier inputs, since no leakage current can flow between two points at the same potential. For example, a PC board trace-to-pad resistance of  $10^{12}\Omega$ , which is normally considered a very large resistance, could leak 5 pA if the trace were a 5V bus adjacent to the pad of the input. This would cause a 250 times degradation from the LMC6574/2's actual performance. However, if a guard ring is held within 5 mV of the inputs, then even a resistance of  $10^{11}\Omega$  would cause only 0.05 pA of leakage current. See [Figure 8](#) for typical connections of guard rings for standard op-amp configurations.

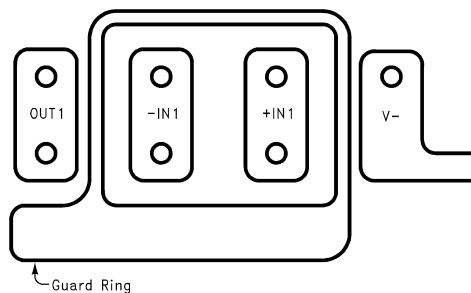

Figure 5. Example of Guard Ring in P.C. Board Layout

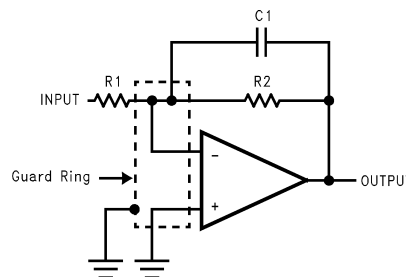

Figure 6. Inverting Amplifier

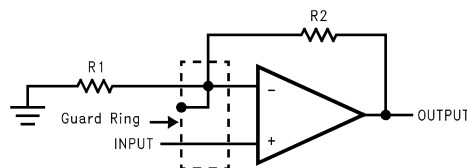
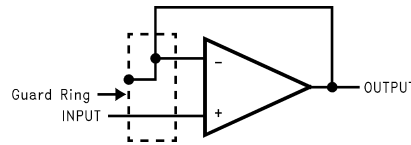

Figure 7. Non-Inverting Amplifier



Follower

**Figure 8. Typical Connections of Guard Rings**

The designer should be aware that when it is inappropriate to lay out a PC board for the sake of just a few circuits, there is another technique which is even better than a guard ring on a PC board: Don't insert the amplifier's input pin into the board at all, but bend it up in the air and use only air as an insulator. Air is an excellent insulator. In this case you may have to forego some of the advantages of PC board construction, but the advantages are sometimes well worth the effort of using point-to-point up-in-the-air wiring. See [Figure 9](#).

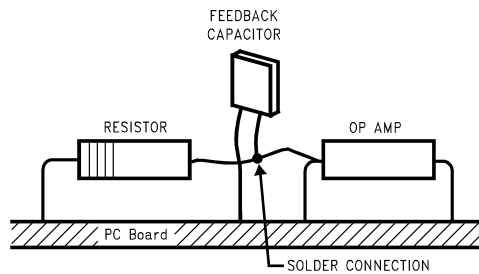

(Input pins are lifted out of PC board and soldered directly to components. All other pins connected to PC board).

**Figure 9. Air Wiring**

**SPICE MACROMODEL**

A spice macromodel is available for the LMC6574/2. This model includes accurate simulation of:

- input common-mode voltage range
- frequency and transient response
- GBW dependence on loading conditions
- quiescent and dynamic supply current
- output swing dependence on loading conditions

and many more characteristics as listed on the macromodel disk.

Contact your local National Semiconductor sales office to obtain an operational amplifier spice model library disk.

**Typical Single-Supply Applications**

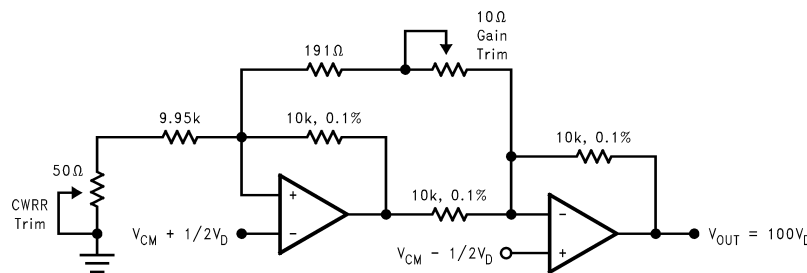

**Figure 10. Low-Power Two-Op-Amp Instrumentation Amplifier**

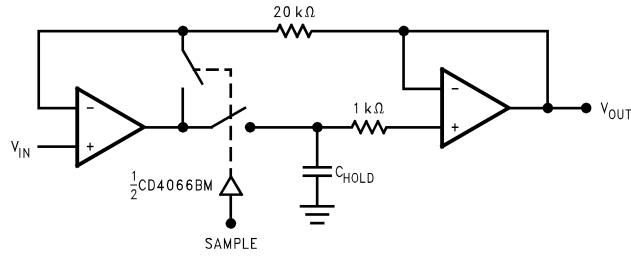

Figure 11. Sample and Hold

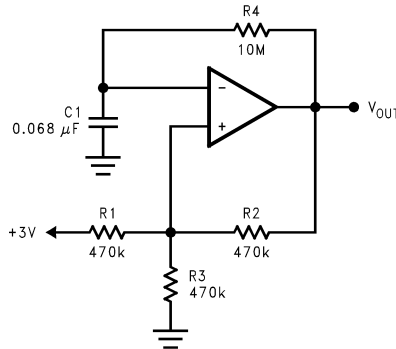

Figure 12. 1 Hz Square Wave Oscillator

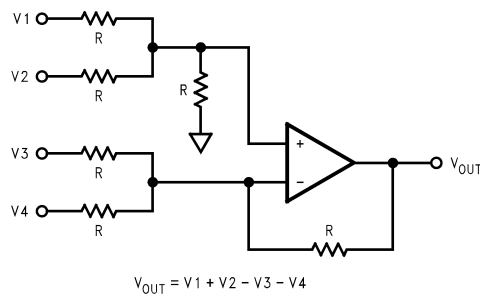

Figure 13. Adder/Subtractor Circuit

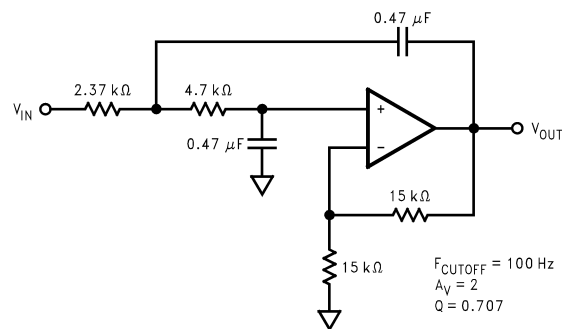

Figure 14. Low Pass Filter

**PACKAGING INFORMATION**

Orderable Device	Status (1)	Package Type	Package Drawing	Pins	Package Qty	Eco Plan (2)	Lead/Ball Finish	MSL Peak Temp (3)	Samples (Requires Login)
LMC6572AIM	ACTIVE	SOIC	D	8	95	TBD	CU SNPB	Level-1-235C-UNLIM	
LMC6572AIM/NOPB	ACTIVE	SOIC	D	8	95	Green (RoHS & no Sb/Br)	CU SN	Level-1-260C-UNLIM	
LMC6572AIMX	ACTIVE	SOIC	D	8	2500	TBD	CU SNPB	Level-1-235C-UNLIM	
LMC6572AIMX/NOPB	ACTIVE	SOIC	D	8	2500	Green (RoHS & no Sb/Br)	CU SN	Level-1-260C-UNLIM	
LMC6572BIM	ACTIVE	SOIC	D	8	95	TBD	CU SNPB	Level-1-235C-UNLIM	
LMC6572BIM/NOPB	ACTIVE	SOIC	D	8	95	Green (RoHS & no Sb/Br)	CU SN	Level-1-260C-UNLIM	
LMC6572BIMX	ACTIVE	SOIC	D	8	2500	TBD	CU SNPB	Level-1-235C-UNLIM	
LMC6572BIMX/NOPB	ACTIVE	SOIC	D	8	2500	Green (RoHS & no Sb/Br)	CU SN	Level-1-260C-UNLIM	
LMC6574AIM	ACTIVE	SOIC	D	14	55	TBD	CU SNPB	Level-1-235C-UNLIM	
LMC6574AIM/NOPB	ACTIVE	SOIC	D	14	55	Green (RoHS & no Sb/Br)	CU SN	Level-1-260C-UNLIM	
LMC6574AIMX	ACTIVE	SOIC	D	14	2500	TBD	CU SNPB	Level-1-235C-UNLIM	
LMC6574AIMX/NOPB	ACTIVE	SOIC	D	14	2500	Green (RoHS & no Sb/Br)	CU SN	Level-1-260C-UNLIM	
LMC6574BIM	ACTIVE	SOIC	D	14	55	TBD	CU SNPB	Level-1-235C-UNLIM	
LMC6574BIM/NOPB	ACTIVE	SOIC	D	14	55	Green (RoHS & no Sb/Br)	CU SN	Level-1-260C-UNLIM	
LMC6574BIMX	ACTIVE	SOIC	D	14	2500	TBD	CU SNPB	Level-1-235C-UNLIM	
LMC6574BIMX/NOPB	ACTIVE	SOIC	D	14	2500	Green (RoHS & no Sb/Br)	CU SN	Level-1-260C-UNLIM	

(1) The marketing status values are defined as follows:

**ACTIVE:** Product device recommended for new designs.

**LIFEBUY:** TI has announced that the device will be discontinued, and a lifetime-buy period is in effect.

**NRND:** Not recommended for new designs. Device is in production to support existing customers, but TI does not recommend using this part in a new design.

**PREVIEW:** Device has been announced but is not in production. Samples may or may not be available.

**OBSELETE:** TI has discontinued the production of the device.

(2) Eco Plan - The planned eco-friendly classification: Pb-Free (RoHS), Pb-Free (RoHS Exempt), or Green (RoHS & no Sb/Br) - please check <http://www.ti.com/productcontent> for the latest availability information and additional product content details.

---

**TBD:** The Pb-Free/Green conversion plan has not been defined.

**Pb-Free (RoHS):** TI's terms "Lead-Free" or "Pb-Free" mean semiconductor products that are compatible with the current RoHS requirements for all 6 substances, including the requirement that lead not exceed 0.1% by weight in homogeneous materials. Where designed to be soldered at high temperatures, TI Pb-Free products are suitable for use in specified lead-free processes.

**Pb-Free (RoHS Exempt):** This component has a RoHS exemption for either 1) lead-based flip-chip solder bumps used between the die and package, or 2) lead-based die adhesive used between the die and leadframe. The component is otherwise considered Pb-Free (RoHS compatible) as defined above.

**Green (RoHS & no Sb/Br):** TI defines "Green" to mean Pb-Free (RoHS compatible), and free of Bromine (Br) and Antimony (Sb) based flame retardants (Br or Sb do not exceed 0.1% by weight in homogeneous material)

<sup>(3)</sup> MSL, Peak Temp. -- The Moisture Sensitivity Level rating according to the JEDEC industry standard classifications, and peak solder temperature.

**Important Information and Disclaimer:** The information provided on this page represents TI's knowledge and belief as of the date that it is provided. TI bases its knowledge and belief on information provided by third parties, and makes no representation or warranty as to the accuracy of such information. Efforts are underway to better integrate information from third parties. TI has taken and continues to take reasonable steps to provide representative and accurate information but may not have conducted destructive testing or chemical analysis on incoming materials and chemicals. TI and TI suppliers consider certain information to be proprietary, and thus CAS numbers and other limited information may not be available for release.

In no event shall TI's liability arising out of such information exceed the total purchase price of the TI part(s) at issue in this document sold by TI to Customer on an annual basis.

**TAPE AND REEL INFORMATION**

**QUADRANT ASSIGNMENTS FOR PIN 1 ORIENTATION IN TAPE**

\*All dimensions are nominal

Device	Package Type	Package Drawing	Pins	SPQ	Reel Diameter (mm)	Reel Width W1 (mm)	A0 (mm)	B0 (mm)	K0 (mm)	P1 (mm)	W (mm)	Pin1 Quadrant
LMC6572AIMX	SOIC	D	8	2500	330.0	12.4	6.5	5.4	2.0	8.0	12.0	Q1
LMC6572AIMX/NOPB	SOIC	D	8	2500	330.0	12.4	6.5	5.4	2.0	8.0	12.0	Q1
LMC6572BIMX	SOIC	D	8	2500	330.0	12.4	6.5	5.4	2.0	8.0	12.0	Q1
LMC6572BIMX/NOPB	SOIC	D	8	2500	330.0	12.4	6.5	5.4	2.0	8.0	12.0	Q1
LMC6574AIMX	SOIC	D	14	2500	330.0	16.4	6.5	9.35	2.3	8.0	16.0	Q1
LMC6574AIMX/NOPB	SOIC	D	14	2500	330.0	16.4	6.5	9.35	2.3	8.0	16.0	Q1
LMC6574BIMX	SOIC	D	14	2500	330.0	16.4	6.5	9.35	2.3	8.0	16.0	Q1
LMC6574BIMX/NOPB	SOIC	D	14	2500	330.0	16.4	6.5	9.35	2.3	8.0	16.0	Q1



**TAPE AND REEL BOX DIMENSIONS**

\*All dimensions are nominal

Device	Package Type	Package Drawing	Pins	SPQ	Length (mm)	Width (mm)	Height (mm)
LMC6572AIMX	SOIC	D	8	2500	349.0	337.0	45.0
LMC6572AIMX/NOPB	SOIC	D	8	2500	349.0	337.0	45.0
LMC6572BIMX	SOIC	D	8	2500	349.0	337.0	45.0
LMC6572BIMX/NOPB	SOIC	D	8	2500	349.0	337.0	45.0
LMC6574AIMX	SOIC	D	14	2500	349.0	337.0	45.0
LMC6574AIMX/NOPB	SOIC	D	14	2500	349.0	337.0	45.0
LMC6574BIMX	SOIC	D	14	2500	349.0	337.0	45.0
LMC6574BIMX/NOPB	SOIC	D	14	2500	349.0	337.0	45.0

D (R-PDSO-G14)

PLASTIC SMALL OUTLINE





- NOTES:
- A. All linear dimensions are in inches (millimeters).
  - B. This drawing is subject to change without notice.
  - Body length does not include mold flash, protrusions, or gate burrs. Mold flash, protrusions, or gate burrs shall not exceed 0.006 (0,15) each side.
  - Body width does not include interlead flash. Interlead flash shall not exceed 0.017 (0,43) each side.
  - E. Reference JEDEC MS-012 variation AB.

D (R-PDSO-G8)

PLASTIC SMALL OUTLINE



- NOTES:
- A. All linear dimensions are in inches (millimeters).
  - B. This drawing is subject to change without notice.
  -  Body length does not include mold flash, protrusions, or gate burrs. Mold flash, protrusions, or gate burrs shall not exceed 0.006 (0,15) each side.
  -  Body width does not include interlead flash. Interlead flash shall not exceed 0.017 (0,43) each side.
  - E. Reference JEDEC MS-012 variation AA.

## IMPORTANT NOTICE

Texas Instruments Incorporated and its subsidiaries (TI) reserve the right to make corrections, enhancements, improvements and other changes to its semiconductor products and services per JESD46, latest issue, and to discontinue any product or service per JESD48, latest issue. Buyers should obtain the latest relevant information before placing orders and should verify that such information is current and complete. All semiconductor products (also referred to herein as "components") are sold subject to TI's terms and conditions of sale supplied at the time of order acknowledgment.

TI warrants performance of its components to the specifications applicable at the time of sale, in accordance with the warranty in TI's terms and conditions of sale of semiconductor products. Testing and other quality control techniques are used to the extent TI deems necessary to support this warranty. Except where mandated by applicable law, testing of all parameters of each component is not necessarily performed.

TI assumes no liability for applications assistance or the design of Buyers' products. Buyers are responsible for their products and applications using TI components. To minimize the risks associated with Buyers' products and applications, Buyers should provide adequate design and operating safeguards.

TI does not warrant or represent that any license, either express or implied, is granted under any patent right, copyright, mask work right, or other intellectual property right relating to any combination, machine, or process in which TI components or services are used. Information published by TI regarding third-party products or services does not constitute a license to use such products or services or a warranty or endorsement thereof. Use of such information may require a license from a third party under the patents or other intellectual property of the third party, or a license from TI under the patents or other intellectual property of TI.

Reproduction of significant portions of TI information in TI data books or data sheets is permissible only if reproduction is without alteration and is accompanied by all associated warranties, conditions, limitations, and notices. TI is not responsible or liable for such altered documentation. Information of third parties may be subject to additional restrictions.

Resale of TI components or services with statements different from or beyond the parameters stated by TI for that component or service voids all express and any implied warranties for the associated TI component or service and is an unfair and deceptive business practice. TI is not responsible or liable for any such statements.

Buyer acknowledges and agrees that it is solely responsible for compliance with all legal, regulatory and safety-related requirements concerning its products, and any use of TI components in its applications, notwithstanding any applications-related information or support that may be provided by TI. Buyer represents and agrees that it has all the necessary expertise to create and implement safeguards which anticipate dangerous consequences of failures, monitor failures and their consequences, lessen the likelihood of failures that might cause harm and take appropriate remedial actions. Buyer will fully indemnify TI and its representatives against any damages arising out of the use of any TI components in safety-critical applications.

In some cases, TI components may be promoted specifically to facilitate safety-related applications. With such components, TI's goal is to help enable customers to design and create their own end-product solutions that meet applicable functional safety standards and requirements. Nonetheless, such components are subject to these terms.

No TI components are authorized for use in FDA Class III (or similar life-critical medical equipment) unless authorized officers of the parties have executed a special agreement specifically governing such use.

Only those TI components which TI has specifically designated as military grade or "enhanced plastic" are designed and intended for use in military/aerospace applications or environments. Buyer acknowledges and agrees that any military or aerospace use of TI components which have **not** been so designated is solely at the Buyer's risk, and that Buyer is solely responsible for compliance with all legal and regulatory requirements in connection with such use.

TI has specifically designated certain components as meeting ISO/TS16949 requirements, mainly for automotive use. In any case of use of non-designated products, TI will not be responsible for any failure to meet ISO/TS16949.

### Products

Audio	<a href="http://www.ti.com/audio">www.ti.com/audio</a>
Amplifiers	<a href="http://amplifier.ti.com">amplifier.ti.com</a>
Data Converters	<a href="http://dataconverter.ti.com">dataconverter.ti.com</a>
DLP® Products	<a href="http://www.dlp.com">www.dlp.com</a>
DSP	<a href="http://dsp.ti.com">dsp.ti.com</a>
Clocks and Timers	<a href="http://www.ti.com/clocks">www.ti.com/clocks</a>
Interface	<a href="http://interface.ti.com">interface.ti.com</a>
Logic	<a href="http://logic.ti.com">logic.ti.com</a>
Power Mgmt	<a href="http://power.ti.com">power.ti.com</a>
Microcontrollers	<a href="http://microcontroller.ti.com">microcontroller.ti.com</a>
RFID	<a href="http://www.ti-rfid.com">www.ti-rfid.com</a>
OMAP Applications Processors	<a href="http://www.ti.com/omap">www.ti.com/omap</a>
Wireless Connectivity	<a href="http://www.ti.com/wirelessconnectivity">www.ti.com/wirelessconnectivity</a>

### Applications

Automotive and Transportation	<a href="http://www.ti.com/automotive">www.ti.com/automotive</a>
Communications and Telecom	<a href="http://www.ti.com/communications">www.ti.com/communications</a>
Computers and Peripherals	<a href="http://www.ti.com/computers">www.ti.com/computers</a>
Consumer Electronics	<a href="http://www.ti.com/consumer-apps">www.ti.com/consumer-apps</a>
Energy and Lighting	<a href="http://www.ti.com/energy">www.ti.com/energy</a>
Industrial	<a href="http://www.ti.com/industrial">www.ti.com/industrial</a>
Medical	<a href="http://www.ti.com/medical">www.ti.com/medical</a>
Security	<a href="http://www.ti.com/security">www.ti.com/security</a>
Space, Avionics and Defense	<a href="http://www.ti.com/space-avionics-defense">www.ti.com/space-avionics-defense</a>
Video and Imaging	<a href="http://www.ti.com/video">www.ti.com/video</a>

### TI E2E Community

[e2e.ti.com](http://e2e.ti.com)