

Micro-Power Voltage Detectors with Manual Reset

General Description

The RT9833 is a micro-power voltage detector with deglitched manual reset input supervising the power supply voltage level for microprocessors (μP) or digital systems. It provides internally fixed threshold levels with 0.1V per step ranging from 1V to 5V, which covers most digital applications. It features low supply current of $3\mu\text{A}$. The RT9833 performs supervisory function by sending out a reset signal whenever the V_{DD} voltage falls below a preset threshold level. This reset signal will last the whole period before V_{DD} recovering. Once V_{DD} recovered upcrossing the threshold level, the reset signal will be released after a certain delay time. To pull reset signal low manually, just pull the manual reset input (MR) below the specified V_{IL} level. The RT9833 is available in the SC-82 package.

Ordering Information

RT9833□-□□□□

- Package Type
Y : SC-82
- Lead Plating System
G : Green (Halogen Free and Pb Free)
- Threshold Voltage
12 : 1.2V
13 : 1.3V
:
49 : 4.9V
50 : 5.0V
- Reset Active Timeout Period
A = 0ms ($\overline{\text{RESET}}$)
B = 55ms ($\overline{\text{RESET}}$)
C = 220ms ($\overline{\text{RESET}}$)
D = 450ms ($\overline{\text{RESET}}$)
E = 0ms (RESET)
F = 55ms (RESET)
G = 220ms (RESET)
H = 450ms (RESET)

Features

- Internally Fixed Threshold 1V to 5V in 0.1V Step
- High Accuracy $\pm 1.5\%$
- Low Supply Current $3\mu\text{A}$
- No External Components Required
- Quick Reset within 20 μs
- Built-in Recovery Delay : 0ms, 55ms, 220ms, 450ms Options
- Low Functional Supply Voltage 0.9V
- N-Channel Open-Drain Output
- Small SC-82 Package
- RoHS Compliant and Halogen Free

Applications

- Computers
- Controllers
- Intelligent Instruments
- Critical μP and μC Power Monitoring
- Portable/Battery-Powered Equipment

Marking Information

For marking information, contact our sales representative directly or through a Richtek distributor located in your area.

Note :

Richtek products are :

- ▶ RoHS compliant and compatible with the current requirements of IPC/JEDEC J-STD-020.
- ▶ Suitable for use in SnPb or Pb-free soldering processes.

Simplified Application Circuit

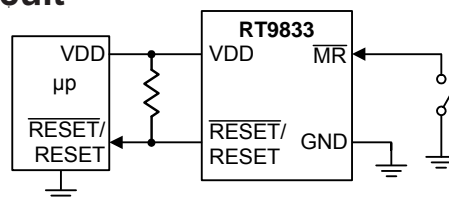

Pin Configuration

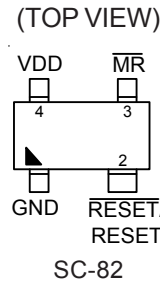

Functional Pin Description

Pin No.	Pin Name	Pin Function
1	GND	Ground.
2	$\overline{\text{RESET}}$	Active Low Open Drain Reset Output.
	RESET	Active High Open Drain Reset Output.
3	$\overline{\text{MR}}$	Manual Reset.
4	VDD	Power.

Functional Block Diagram

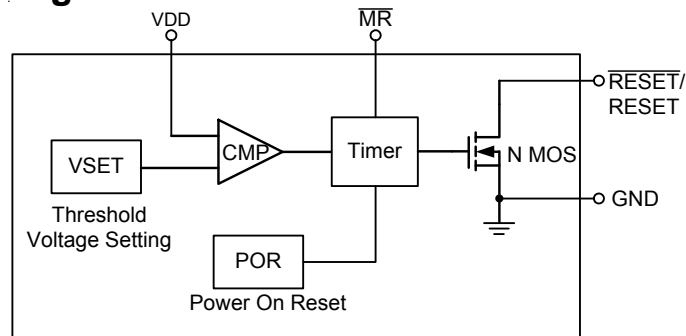

Operation

When VDD is lower than threshold voltage set by VSET circuit, the RESET output becomes high. If VDD remains higher than the threshold voltage with a hysteresis voltage, Timer will be active. After a specific delay time, the RESET output becomes low. There is an internal pull-high resistor connected to the $\overline{\text{MR}}$ pin. $\overline{\text{MR}}$ resets the RT9833 only when it is pulled low. When $\overline{\text{MR}}$ releases and waits for a delay time, output returns to its normal state related to VDD. It is an open drain output type of Reset IC.

Timer

The Timer provides four kinds of delay time options including 0ms, 55ms, 220ms, and 450ms.

VSET

The VSET generates a fixed threshold voltage.

CMP

Voltage Comparator which compares the voltage difference between threshold voltage and VDD.

POR

Power on reset. It will set all digital logic to the right state when power on.

Absolute Maximum Ratings (Note 1)

- Terminal Voltage (with Respect to GND)
 VDD ----- -0.3V to 6V
- All Other Inputs ----- -0.3V to (V_{DD} + 0.3V)
- Input Current, I_{VDD} ----- 20mA
- Power Dissipation, P_D @ T_A = 25°C
 SC-82 ----- 0.29W
- Package Thermal Resistance (Note 2)
 SC-82, θ_{JA} ----- 345.6°C/W
- Lead Temperature (Soldering, 10sec.) ----- 260°C
- Storage Temperature Range ----- -65°C to 125°C
- ESD Susceptibility (Note 3)
 HBM (Human Body Model) ----- 2kV

Recommended Operating Conditions (Note 4)

- Junction Temperature Range ----- -40°C to 125°C
- Ambient Temperature Range ----- -40°C to 85°C

Electrical Characteristics

(V_{DD} = 3V, unless otherwise specified)

Parameter	Symbol	Test Conditions	Min	Typ	Max	Unit	
Operating V _{DD} (V _{OUT}) Range	V _{DD}		0.9	--	6	V	
Supply Current	I _{DD}	V _{TH} = 3V, V _{DD} = 4.5V, T _A = 27°C	--	3	8	μA	
Reset Threshold	V _{TH}	T _A = 27°C	--	1.2 to 5	--	V	
MR Input Threshold	V _{IL}	T _A = 27°C, V _{TH} > 1.2V	--	--	0.25V _{DD}	V	
	V _{IH}	T _A = 27°C, V _{TH} > 1.2V	0.7V _{DD}	--	--		
Threshold Voltage Accuracy	ΔV _{TH}	T _A = 27°C	-1.5	--	1.5	%	
V _{DD} Drop to Reset Delay	t _{RD}	Drop = V _{TH} - 125mV	--	20	--	μs	
$\overline{\text{MR}}$ Active Timeout Period	RT9833A/E	t $\overline{\text{MR}}$		--	0	--	ms
	RT9833B/F			35	55	75	
	RT9833C/G			143	220	297	
	RT9833D/H			292	450	608	
$\overline{\text{MR}}$ Input Voltage Threshold	Logic-High	V $\overline{\text{MR}}_{\text{H}}$	V _{DD} > V _{TH(MAX)}	0.75 x V _{DD}	--	V _{DD}	V
	Logic-Low	V $\overline{\text{MR}}_{\text{L}}$	V _{DD} > V _{TH(MAX)}	--	--	0.25 x V _{DD}	
Reset Active Time Out Period	RT9833A/E	t _{RP}	V _{DD} ≥ 1.02xV _{TH}	--	0	--	ms
	RT9833B/F			35	55	75	
	RT9833C/G			143	220	297	
	RT9833D/H			292	450	608	
RESET Output Voltage Low	V _{OL}	3 = V _{DD} < V _{TH} SINK > 3.5mA	--	--	0.4	V	
Hysteresis Width	V _{HYS}		--	0.01V _{TH}	--	V	

Note 1. Stresses beyond those listed under “Absolute Maximum Ratings” may cause permanent damage to the device. These are stress ratings only, and functional operation of the device at these or any other conditions beyond those indicated in the operational sections of the specifications is not implied. Exposure to absolute maximum rating conditions may affect device reliability.

Note 2. θ_{JA} is measured at $T_A = 25^\circ\text{C}$ on a high effective thermal conductivity four-layer test board per JEDEC 51-7.

Note 3. Devices are ESD sensitive. Handling precaution is recommended.

Note 4. The device is not guaranteed to function outside its operating conditions.

Typical Application Circuit

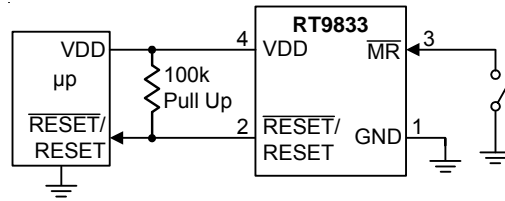

Typical Operating Characteristics

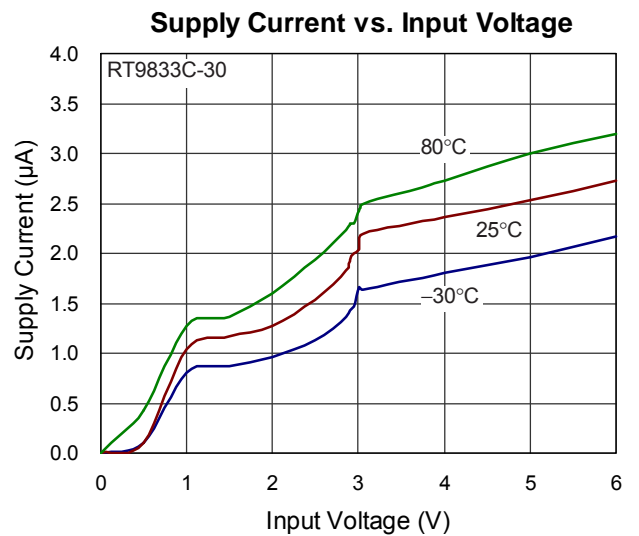
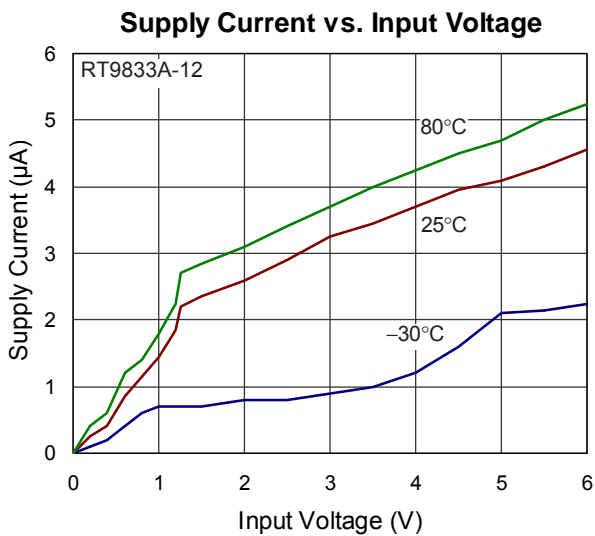
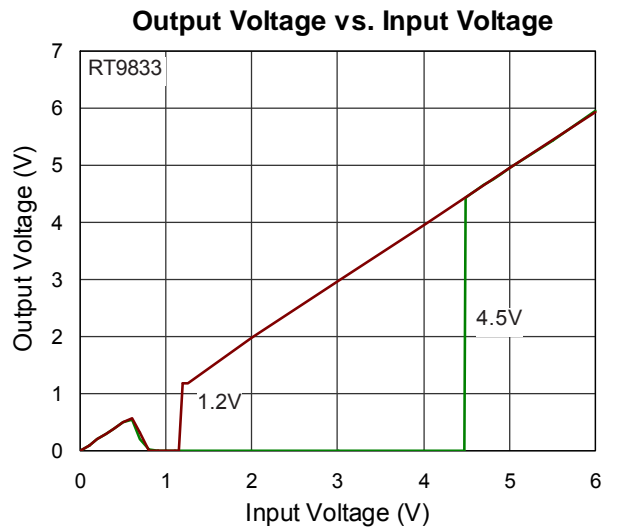
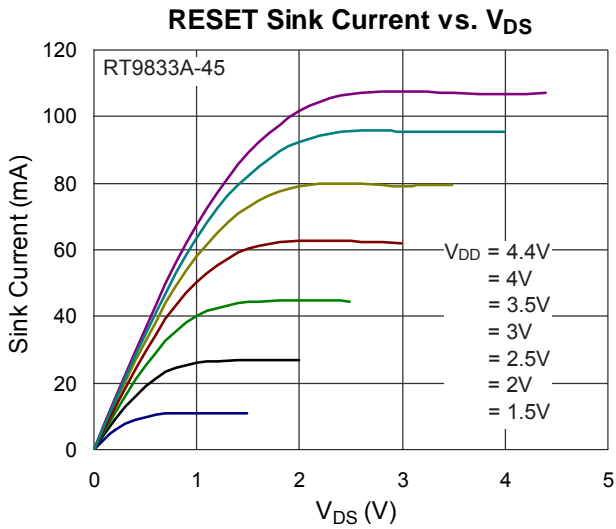
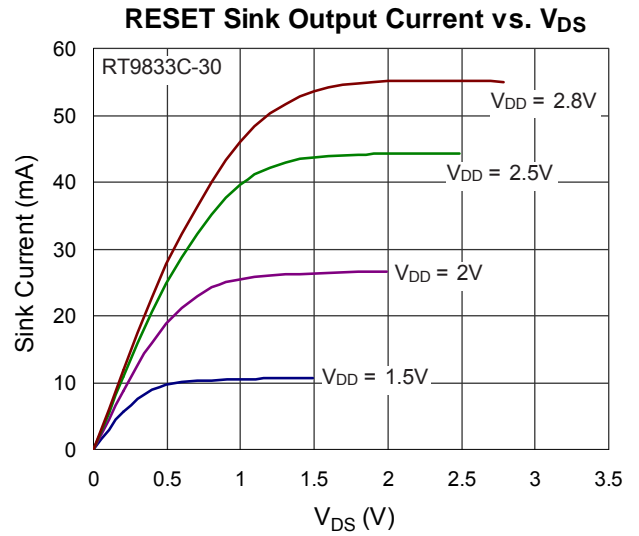
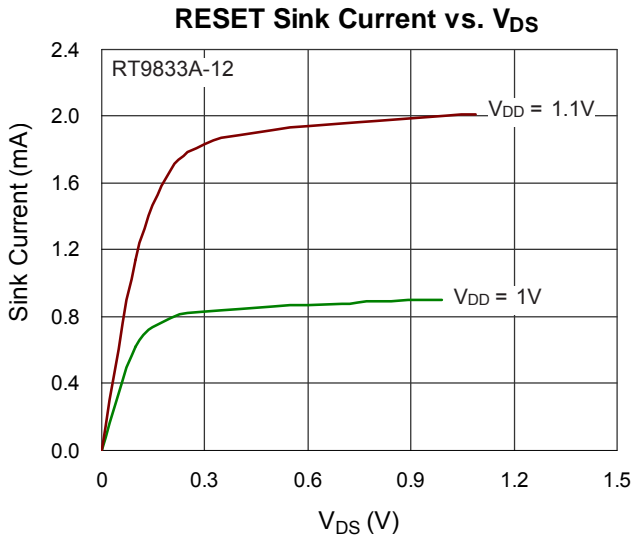

Supply Current vs. Input Voltage

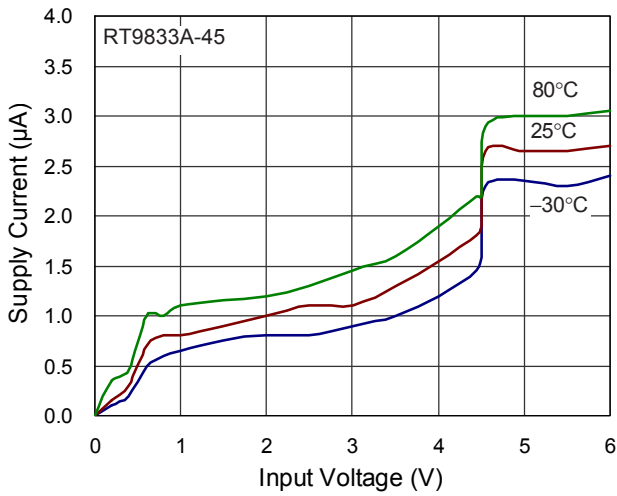

Power Down Reset Delay vs. Temperature

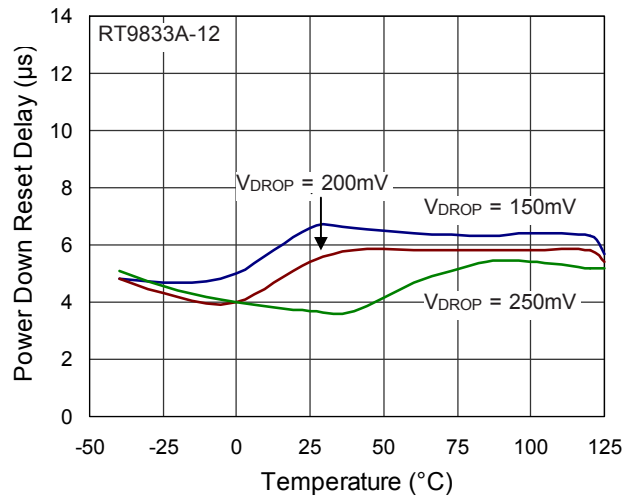

Power Down Reset Delay vs. Temperature

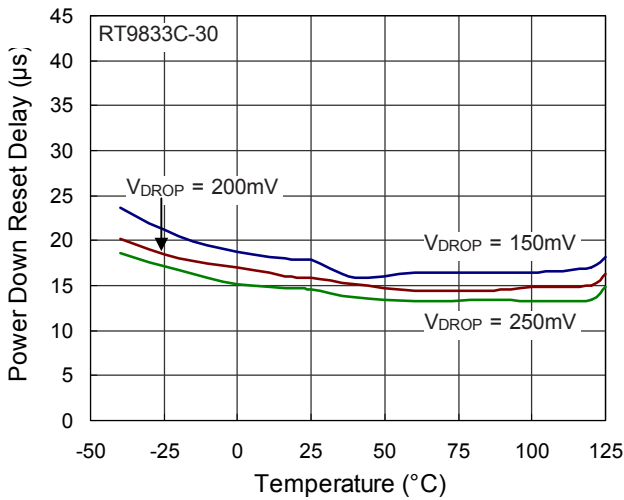

Power Down Reset Delay vs. Temperature

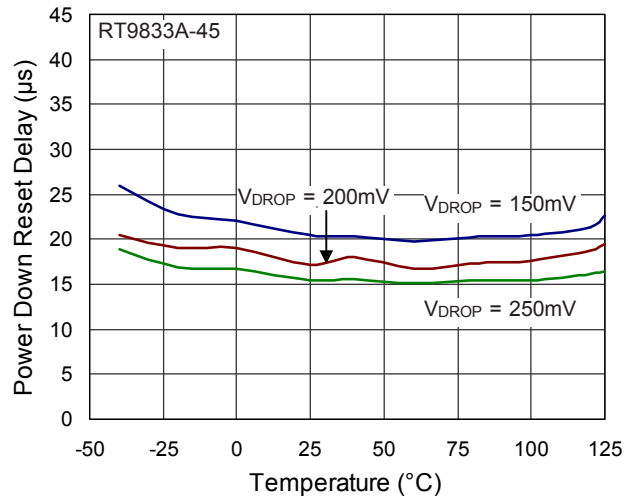

Reset Threshold Deviation vs. Temperature

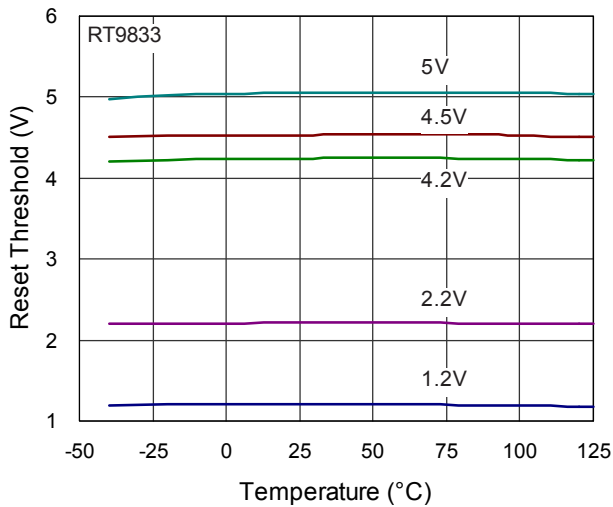

RESET Sink Current vs. Input Voltage

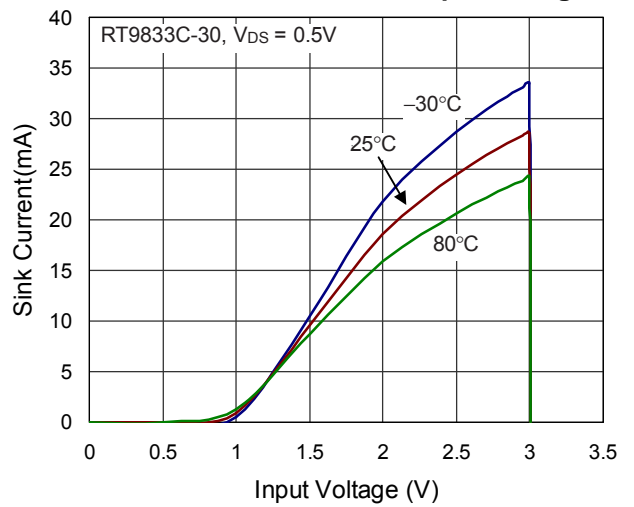

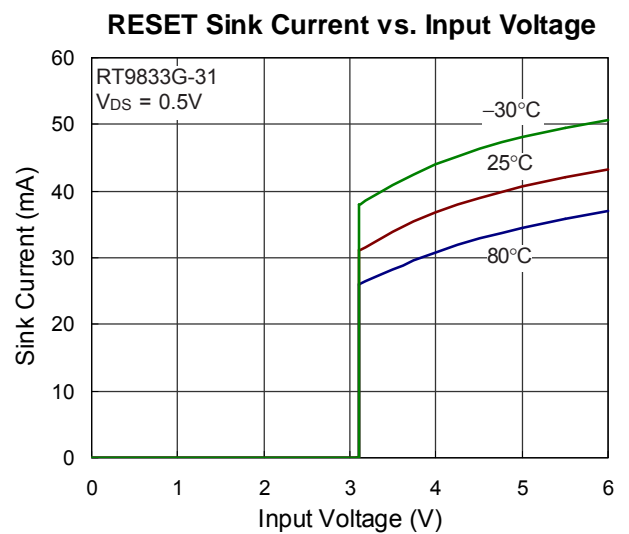
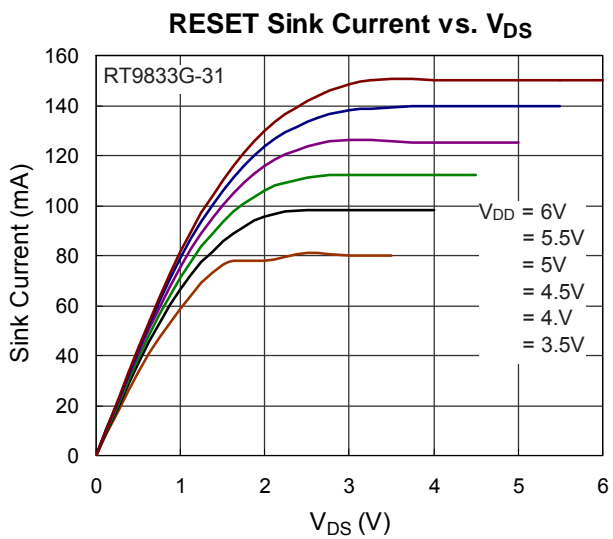
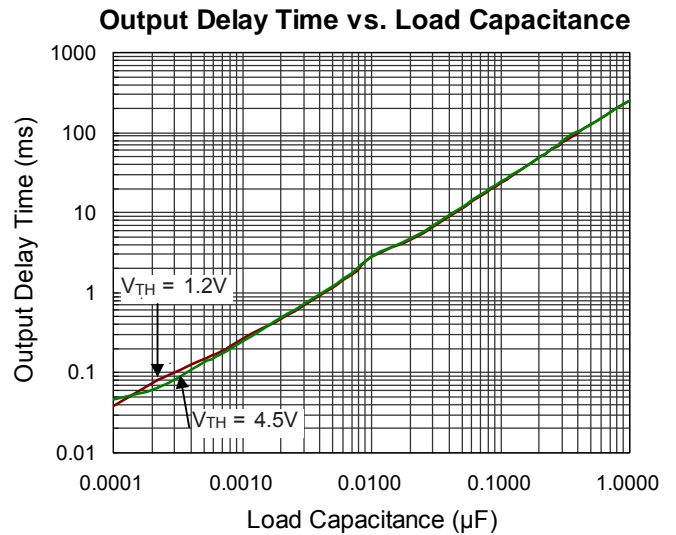
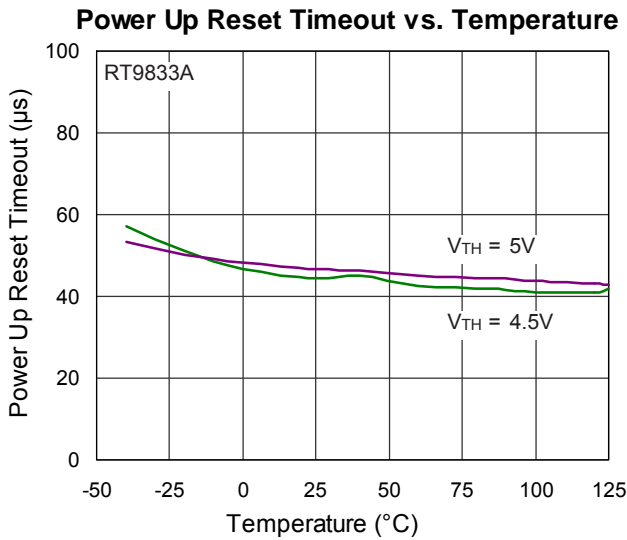
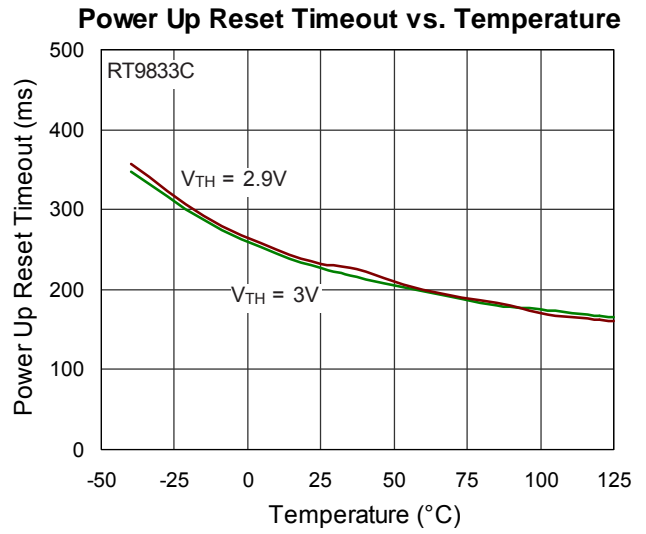
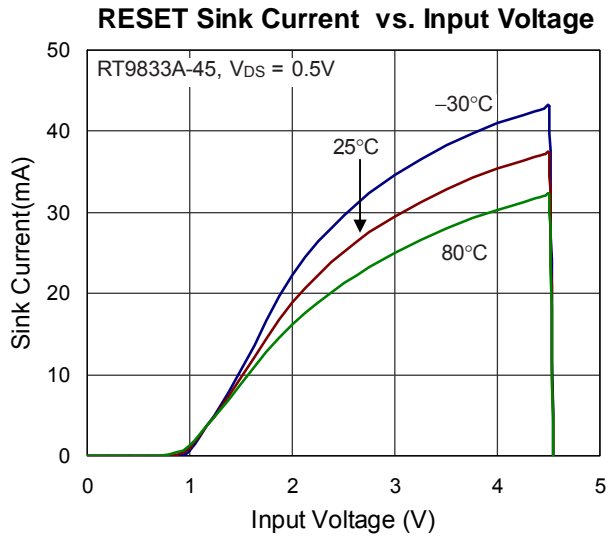

Power Up Reset Timeout vs. Temperature

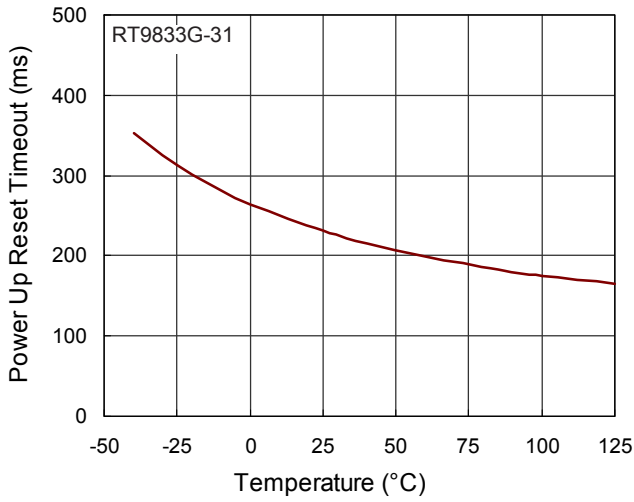

Output Voltage vs. Input Voltage

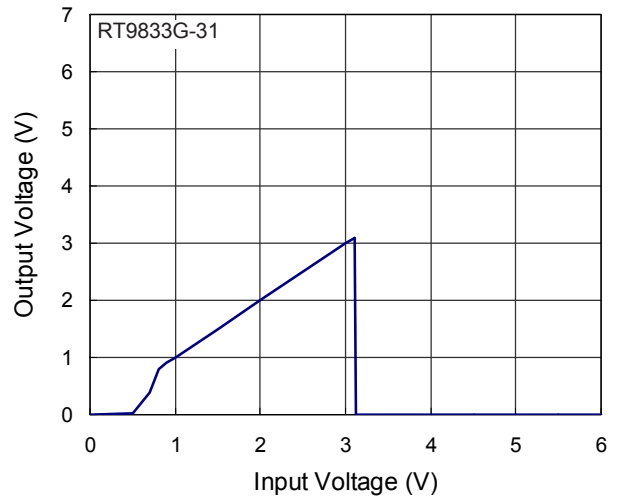

Power Down Reset Delay vs. Temperature

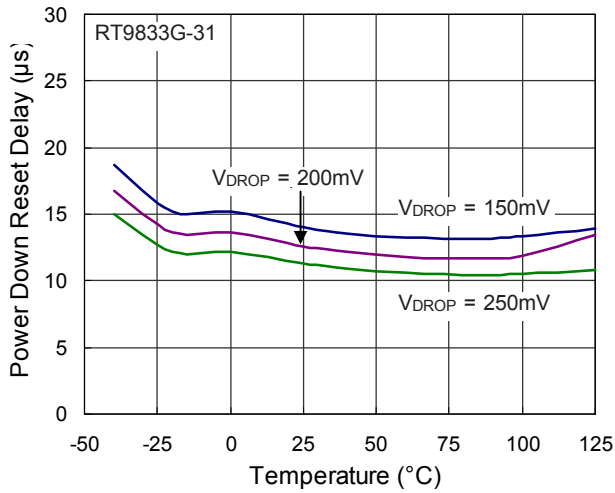

Application Information

Multiple Supplies

Mainly, the pull-up connected to the RT9833 will connect to the supply voltage that is being monitored at the IC's VCC pin. However, some systems may use the open-drain output to level-shift from the monitored supply to reset circuitry powered by some other supply.

Benefits of Highly Accurate Reset Threshold

Most μ P supervisor ICs have reset threshold voltages between 1% and 1.5% below the value of nominal supply voltages. This ensures a reset will not occur within 1% of the nominal supply, but will occur when the supply is 1.5% below nominal.

Thermal Considerations

For continuous operation, do not exceed absolute maximum junction temperature. The maximum power dissipation depends on the thermal resistance of the IC package, PCB layout, rate of surrounding airflow, and difference between junction and ambient temperature. The maximum power dissipation can be calculated by the following formula :

$$P_{D(MAX)} = (T_{J(MAX)} - T_A) / \theta_{JA}$$

where $T_{J(MAX)}$ is the maximum junction temperature, T_A is the ambient temperature, and θ_{JA} is the junction to ambient thermal resistance.

For recommended operating condition specifications, the maximum junction temperature is 125°C. The junction to ambient thermal resistance, θ_{JA} , is layout dependent. SC-82 package, the thermal resistance, θ_{JA} , is 345.6°C/W on a standard JEDEC 51-7 four-layer thermal test board. The maximum power dissipation at $T_A = 25^\circ\text{C}$ can be calculated by the following formula :

$$P_{D(MAX)} = (125^\circ\text{C} - 25^\circ\text{C}) / (345.6^\circ\text{C/W}) = 0.29\text{W for SC-82 package}$$

The maximum power dissipation depends on the operating ambient temperature for fixed $T_{J(MAX)}$ and thermal resistance, θ_{JA} . The derating curve in Figure 1 allows the designer to see the effect of rising ambient temperature on the maximum power dissipation.

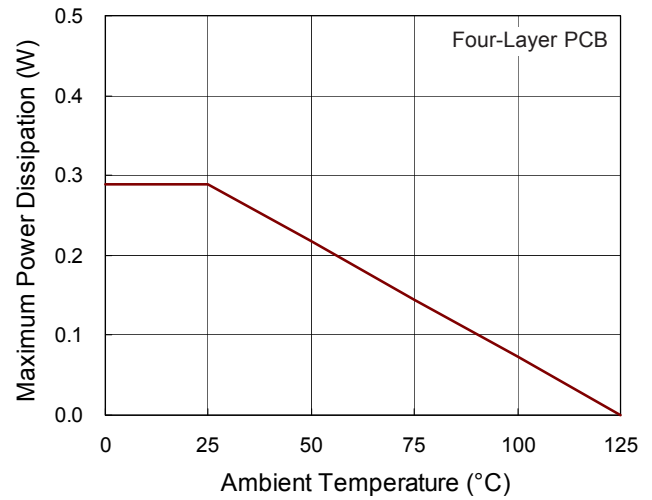
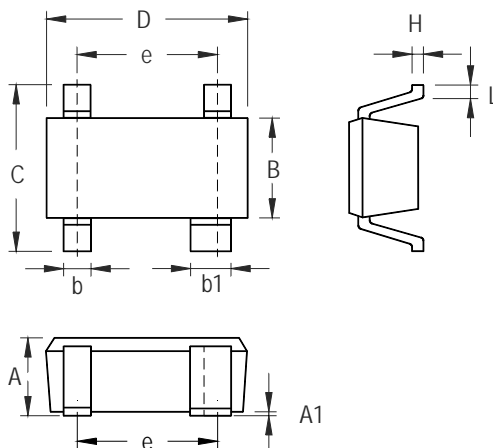

Figure 1. Derating Curve of Maximum Power Dissipation

Outline Dimension



Symbol	Dimensions In Millimeters		Dimensions In Inches	
	Min	Max	Min	Max
A	0.800	1.100	0.031	0.043
A1	0.000	0.100	0.000	0.004
B	1.150	1.350	0.045	0.053
b	0.150	0.400	0.006	0.016
b1	0.350	0.500	0.014	0.020
C	1.800	2.450	0.071	0.096
D	1.800	2.200	0.071	0.087
e	1.300		0.051	
H	0.080	0.260	0.003	0.010
L	0.200	0.460	0.008	0.018

SC-82 Surface Mount Package

Richtek Technology Corporation

5F, No. 20, Taiyuen Street, Chupei City
 Hsinchu, Taiwan, R.O.C.
 Tel: (8863)5526789

Richtek products are sold by description only. Richtek reserves the right to change the circuitry and/or specifications without notice at any time. Customers should obtain the latest relevant information and data sheets before placing orders and should verify that such information is current and complete. Richtek cannot assume responsibility for use of any circuitry other than circuitry entirely embodied in a Richtek product. Information furnished by Richtek is believed to be accurate and reliable. However, no responsibility is assumed by Richtek or its subsidiaries for its use; nor for any infringements of patents or other rights of third parties which may result from its use. No license is granted by implication or otherwise under any patent or patent rights of Richtek or its subsidiaries.