

### Ultra Low capacitance & Low Clamping Voltage Bi-directional ESD / Transient Protection Diodes

#### FEATURES

- Transient protection for data lines to
  - IEC61000-4-2(ESD) : Air mode  $\pm 30kV$  / Contact mode  $\pm 25kV$
  - IEC61000-4-4(EFT) :  $\pm 50A$  (5/50ns)
  - IEC61000-4-5(Surge) : 4A(tp=8/20us)
- Low capacitance  $C_T = 0.5pF$ (Max)
- Bi-directional, symmetrical working voltage up to :  $V_{RWM} = \pm 5V$
- Ultra small Size  $1.0 \times 0.6 \times 0.4mm$
- Low reverse current :  $<25nA$  typical ( $V_R=5V$ )
- Non Suffix : ULP-2 Package ex) PS05TBUL2 -RTL/H
- Suffix **U** : ULP-2 Package& Qualified to AEC-Q101 ex) PS05TBUL2 -RTL/HU
- Suffix **R** : ULP-2(4) Package ex) PS05TBUL2 -RTL/HR
- Suffix **UR** : ULP-2(4) Package&Qualified to AEC-Q101 ex) PS05TBUL2 -RTL/HUR
- Suffix **P** : ULP-2(5) Package ex) PS05TBUL2 -RTL/HP
- Suffix **UP** : ULP-2(5) Package&Qualified to AEC-Q101 ex) PS05TBUL2 -RTL/HUP
- Suffix **J** : ULP-2(6) Package ex) PS05TBUL2 -RTL/HJ
- Suffix **UJ** : ULP-2(6) Package&Qualified to AEC-Q101 ex) PS05TBUL2 -RTL/HUJ



ULP-2 (leadless-type)

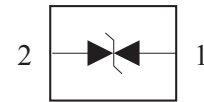

1. ANODE 2. ANODE

Pin configurations (Bi-directional)

#### PRODUCT DESCRIPTION

- Molding compound flammability rating : UL 94V-0
- Pb-Free, Halogen-Free, RoHs Compliant

Package dimensions (ULP-2(3))	Package dimensions (ULP-2(4))	Package dimensions (ULP-2(5))	Package dimensions (ULP-2(6))																																																																		
<table border="1"> <thead> <tr> <th>DIM</th> <th>MILLIMETERS</th> </tr> </thead> <tbody> <tr><td>A</td><td>1.0±0.05</td></tr> <tr><td>B</td><td>0.6±0.05</td></tr> <tr><td>C</td><td>0.4±0.05</td></tr> <tr><td>D</td><td>0.48±0.05</td></tr> <tr><td>E</td><td>0.23±0.05</td></tr> <tr><td>e</td><td>Min 0.125</td></tr> <tr><td>G</td><td>0.65±0.03</td></tr> <tr><td>H</td><td>Typ 0.06</td></tr> </tbody> </table>	DIM	MILLIMETERS	A	1.0±0.05	B	0.6±0.05	C	0.4±0.05	D	0.48±0.05	E	0.23±0.05	e	Min 0.125	G	0.65±0.03	H	Typ 0.06	<table border="1"> <thead> <tr> <th>DIM</th> <th>MILLIMETERS</th> </tr> </thead> <tbody> <tr><td>A</td><td>1.00±0.10</td></tr> <tr><td>B</td><td>0.60±0.10</td></tr> <tr><td>C</td><td>0.40±0.05</td></tr> <tr><td>D</td><td>0.50±0.05</td></tr> <tr><td>E</td><td>0.25±0.05</td></tr> <tr><td>G</td><td>Typ. 0.65</td></tr> <tr><td>H</td><td>0.05±0.05</td></tr> </tbody> </table>	DIM	MILLIMETERS	A	1.00±0.10	B	0.60±0.10	C	0.40±0.05	D	0.50±0.05	E	0.25±0.05	G	Typ. 0.65	H	0.05±0.05	<table border="1"> <thead> <tr> <th>DIM</th> <th>MILLIMETERS</th> </tr> </thead> <tbody> <tr><td>A</td><td>1.00±0.05</td></tr> <tr><td>B</td><td>0.60±0.05</td></tr> <tr><td>C</td><td>0.50±0.05</td></tr> <tr><td>D</td><td>0.50±0.03</td></tr> <tr><td>E</td><td>0.25±0.03</td></tr> <tr><td>G</td><td>0.65 BSC</td></tr> <tr><td>I</td><td>Max 0.03</td></tr> </tbody> </table>	DIM	MILLIMETERS	A	1.00±0.05	B	0.60±0.05	C	0.50±0.05	D	0.50±0.03	E	0.25±0.03	G	0.65 BSC	I	Max 0.03	<table border="1"> <thead> <tr> <th>DIM</th> <th>MILLIMETER</th> </tr> </thead> <tbody> <tr><td>A</td><td>1.00±0.05</td></tr> <tr><td>B</td><td>0.60±0.05</td></tr> <tr><td>C</td><td>0.4±0.05</td></tr> <tr><td>D</td><td>0.50±0.02/-0.04</td></tr> <tr><td>E</td><td>0.25±0.025</td></tr> <tr><td>G</td><td>0.65BSC</td></tr> <tr><td>I</td><td>Max 0.03</td></tr> </tbody> </table>	DIM	MILLIMETER	A	1.00±0.05	B	0.60±0.05	C	0.4±0.05	D	0.50±0.02/-0.04	E	0.25±0.025	G	0.65BSC	I	Max 0.03
DIM	MILLIMETERS																																																																				
A	1.0±0.05																																																																				
B	0.6±0.05																																																																				
C	0.4±0.05																																																																				
D	0.48±0.05																																																																				
E	0.23±0.05																																																																				
e	Min 0.125																																																																				
G	0.65±0.03																																																																				
H	Typ 0.06																																																																				
DIM	MILLIMETERS																																																																				
A	1.00±0.10																																																																				
B	0.60±0.10																																																																				
C	0.40±0.05																																																																				
D	0.50±0.05																																																																				
E	0.25±0.05																																																																				
G	Typ. 0.65																																																																				
H	0.05±0.05																																																																				
DIM	MILLIMETERS																																																																				
A	1.00±0.05																																																																				
B	0.60±0.05																																																																				
C	0.50±0.05																																																																				
D	0.50±0.03																																																																				
E	0.25±0.03																																																																				
G	0.65 BSC																																																																				
I	Max 0.03																																																																				
DIM	MILLIMETER																																																																				
A	1.00±0.05																																																																				
B	0.60±0.05																																																																				
C	0.4±0.05																																																																				
D	0.50±0.02/-0.04																																																																				
E	0.25±0.025																																																																				
G	0.65BSC																																																																				
I	Max 0.03																																																																				

#### ORDERING INFORMATION

Part Number	Qty per Reel	Reel Size	Marking code
PS05TBUL2-RTL	10,000	7 inch	88

# PS05TBUL2

## MAXIMUM RATING (Ta=25°C)

CHARACTERISTIC	SYMBOL	RATING	UNIT
Peak Pulse Power (tp=8/20 μs)	P <sub>PK</sub>	60	W
Peak Pulse Current (tp=8/20 μs)	I <sub>PP</sub>	4	A
Junction Temperature	T <sub>J</sub>	150	°C
Storage Temperature	T <sub>STG</sub>	-55 ~ 150	°C

## DEFINITIONS OF ELECTRICAL CHARACTERISTIC SYMBOL

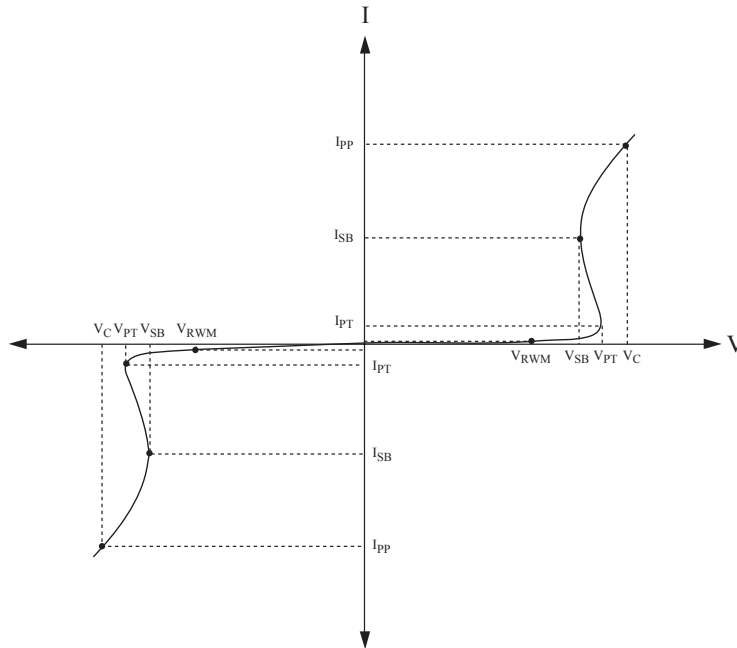

## ELECTRICAL CHARACTERISTICS (Ta=25°C)

CHARACTERISTIC	SYMBOL	TEST CONDITION	MIN.	TYP.	MAX.	UNIT
Reverse Stand-Off Voltage	V <sub>RWM</sub>	-	-	-	5	V
Reverse Leakage Current	I <sub>R</sub>	V <sub>RWM</sub> =5V	-	25	100	nA
Snab-back Voltage	V <sub>SB</sub>	I <sub>SB</sub> =100 μA, I <sub>SB</sub> =50mA	5.5	-	-	V
Punch-through Voltage	V <sub>PT</sub>	I <sub>PT</sub> =2 μA	6	8	10	V
Total Capacitance	C <sub>T</sub>	V <sub>R</sub> =0V, f=1MHz	-	0.4	0.5	pF
Clamping Voltage	V <sub>C</sub>	I <sub>PP</sub> =1A, tp=8/20 μs (IEC61000-4-5)	-	9	12	V
		I <sub>PP</sub> =4A, tp=8/20 μs (IEC61000-4-5)	-	12	15	
		I <sub>TLF</sub> =4A, tp=100ns	-	10	15	
		I <sub>TLF</sub> =20A, tp=100ns	-	26	30	
Electrostatic Discharge	V <sub>ESD</sub>	IEC61000-4-2	Air	±30	-	kV
			Contact	±25	-	

# PS05TBUL2

## TYPICAL CHARACTERISTICS (Ta=25°C)

NON-REPETITIVE PEAK PULSE POWER VS. PULSE TIME

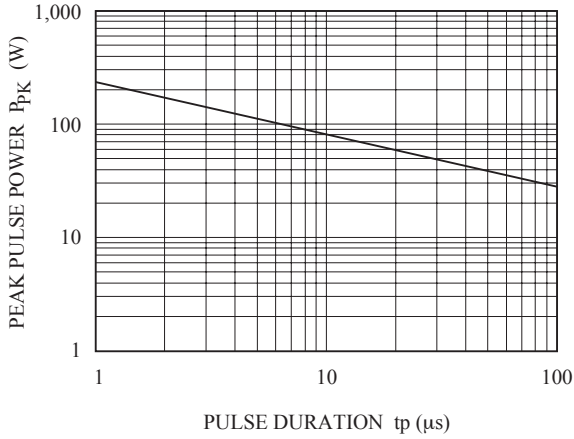

POWER DERATION CURVE

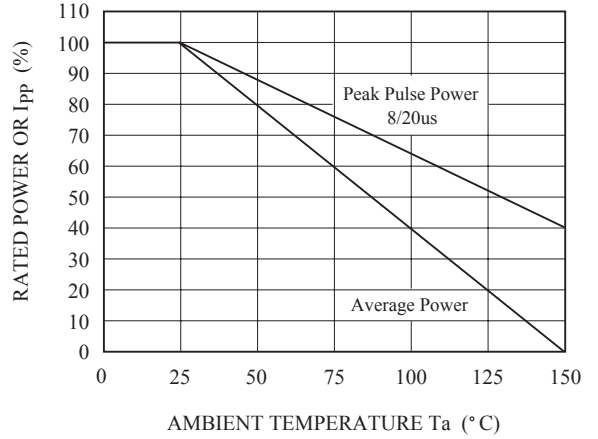

$I_R - V_R$

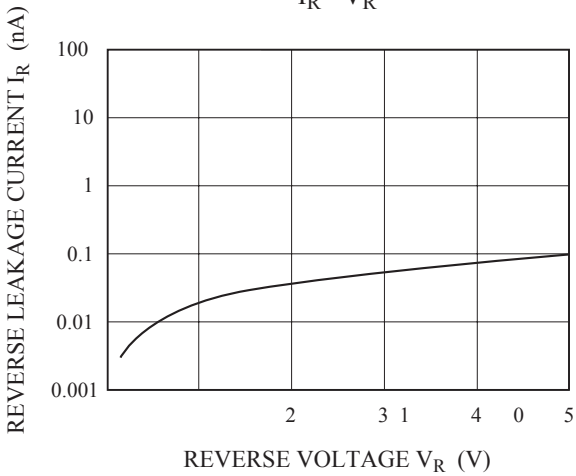

$C_T - V_R$

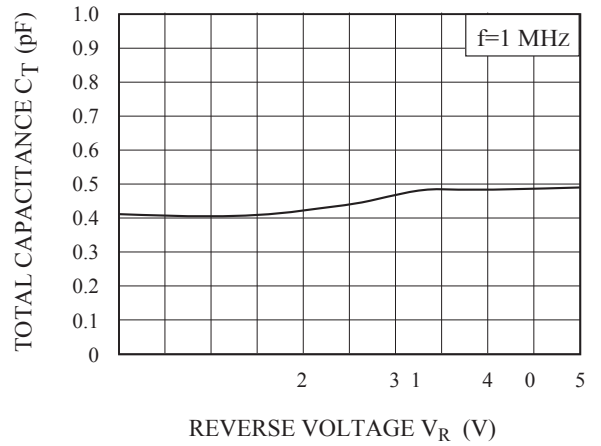

$I_{pp} - V_C$

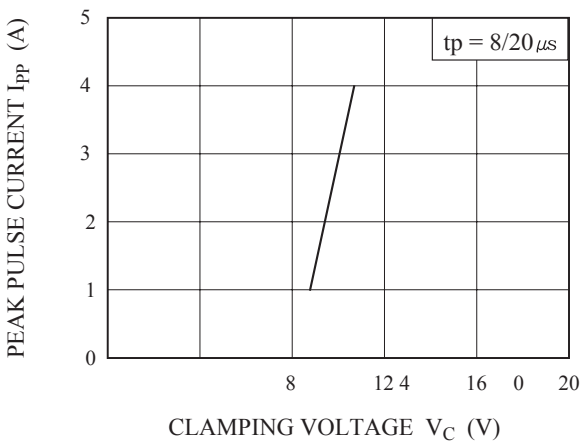

$I_{TLP} - V_C$

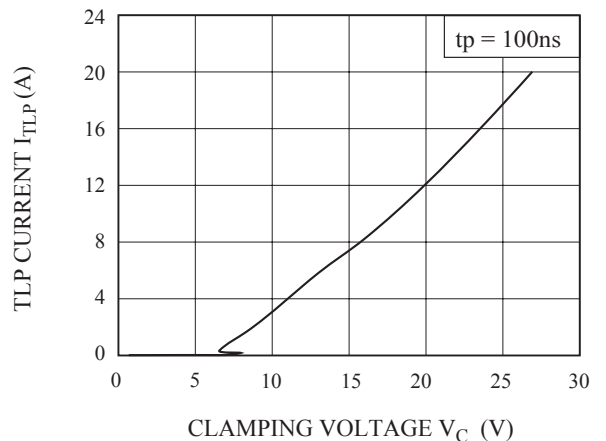

# PS05TBUL2

ESD Clamping  
(+8 kV Contact per IEC 61000-4-2)

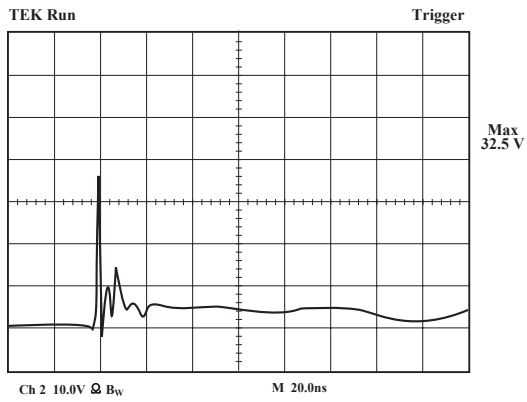

Note : Data is taken with a 10x attenuator

ESD Clamping  
(-8 kV Contact per IEC 61000-4-2)

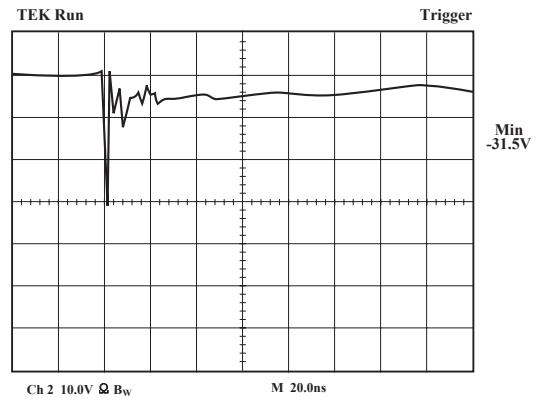

Note : Data is taken with a 10x attenuator

## PULSE WAVEFORM

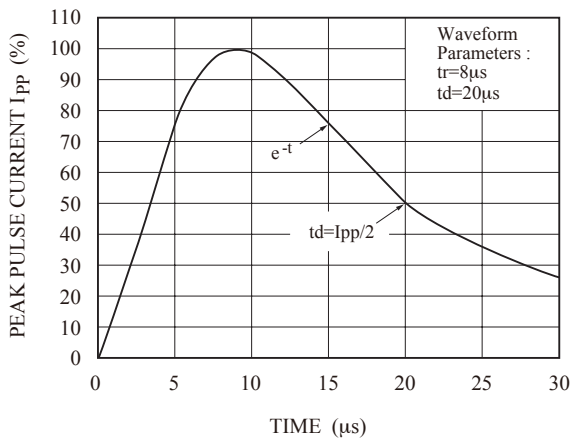

# PS05TBUL2

## APPLICATIONS

- USB 2.0, 10/100/1000 Ethernet, DVI, HDMI, S-ATA
- MDDI Port
- LCD-Display, Camera
- GPS / FM Antennas
- LVDS
- High speed data lines
- Automotive

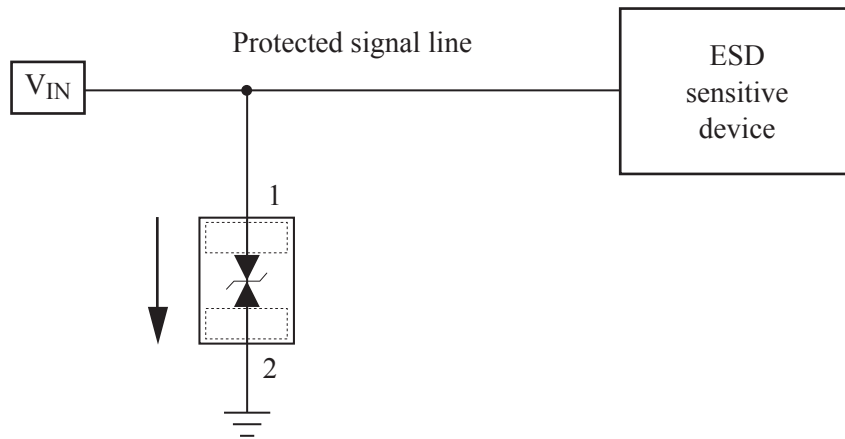

## Recommended pad dimension & Marking Information

Recommended pad dimension	Marking Code
<p>Diagram showing the recommended pad dimensions for the PS05TBUL2 diode. The dimensions are: total width 1.4, distance between pads 0.55, pad height 0.6, distance from left edge to pad center 0.3, and total width including leads 0.85.</p>	<p>Diagram showing the marking code for the PS05TBUL2 diode, which is the number 88 inside a square frame. The terminals are labeled 1 and 2.</p>