



# ATT040N120EQ

## 主要参数 MAIN CHARACTERISTICS

I <sub>c</sub>	40 A
V <sub>CE</sub>	1200V
V <sub>cesat-typ</sub> (V <sub>ge</sub> =15V)	1.5V

## 封装 Package

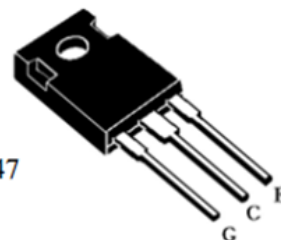
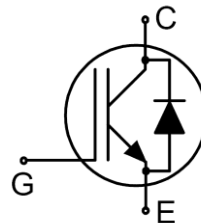

TO-247

### 用途

- 新能源汽车 PTC

### APPLICATIONS

- New Energy Vehicle PTC

### 产品特性

- 低栅极电荷
- Trench FS 技术
- RoHS 产品
- 产品满足 AEC-Q101

### FEATURES

- Low gate charge
- Trench FS Technology
- RoHS product
- AEC-Q101

## 印记定义

## Mark definition

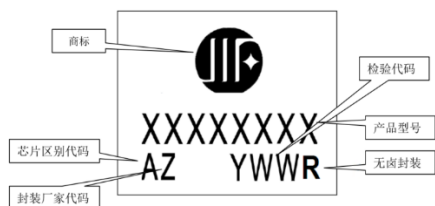

检验代码说明: Y(年代码, 执行内部定义)+WW (周代码)

产品型号说明: 产品类型+工艺平台+参数规格+工艺版本+特殊特性+预留代码

## 订货信息 ORDER MESSAGE

订货型号 Order codes	印记 Marking	封装 Package
无卤-条管 Halogen-Free-Tube		
ATT040N120EQ-GE-BR	ATT040N120EQ	TO-247

绝对最大额定值 ABSOLUTE RATINGS ( $T_C=25^{\circ}\text{C}$ )

项 目 Parameter	符 号 Symbol	数 值 Value	单 位 Unit
最高集电极-发射极直流电压 Collector-Emitter Voltage	$V_{CE}$	1200	V
*连续集电极电流 Collector Current-continuous	$I_C$	80( $T_C=25^{\circ}\text{C}$ )	A
		40( $T_C=100^{\circ}\text{C}$ )	A
最大脉冲集电极极电流 (注1) Collector Current – pulse (note 1)	$I_{CM}$	120	A
二极管正向电流 Diode RMS forward current	$I_F$	80( $T_C=25^{\circ}\text{C}$ )	A
		40( $T_C=100^{\circ}\text{C}$ )	A
二极管正向不重复峰值电流 (浪涌电流) Surge non repetitive forward current $t_p=10\text{ ms}$ sinusoidal	$I_{FSM}$	120	A
栅极发射极电压 Gate-Emitter Voltage	$V_{GE}$	$\pm 30$	V
耗散功率 Power Dissipation	$P_D$ $T_C=25^{\circ}\text{C}$	543	W
存储温度 Storage Temperature Range	$T_{STG}$	$-55\sim+150$	$^{\circ}\text{C}$
结温 Junction Temperature Range	$T_{vj}$	$-55\sim+150$	$^{\circ}\text{C}$
引线最高焊接温度 Maximum Lead Temperature for Soldering Purposes	$T_L$	300	$^{\circ}\text{C}$

\*连续集电极电流由最高结温限制

\*Collector current limited by maximum junction temperature

注释:

1: 脉冲宽度由最高结温限制

Notes:

1: Pulse width limited by maximum junction temperature



## 电特性 ELECTRICAL CHARACTERISTICS

项 目 Parameter	符 号 Symbol	测试条件 Tests conditions	最小 Min	典型 Typ	最大 Max	单位 Units
<b>关态特性 Off-Characteristics</b>						
集电极-发射极击穿电压 Collector-Emitter Voltage	$BV_{CES}$	$I_C=250\mu A, V_{GE}=0V$	1200	-	-	V
击穿电压温度特性 Breakdown Voltage Temperature Coefficient	$\Delta BV_{CES}/\Delta T_J$	$I_C=0.5mA$ , referenced to $25^\circ C$	-	0.6	-	$V/^\circ C$
零栅压下集电极漏电流 Zero Gate Voltage Collector Current	$I_{CES}$	$V_{CE}=1200V, V_{GE}=0V, T_C=25^\circ C$	-	-	0.2	mA
		$V_{CE}=1200V, V_{GE}=0V, T_C=150^\circ C$	-	-	1.5	mA
正向栅极体漏电流 Gate-body leakage current, forward	$I_{GESF}$	$V_{CE}=0V, V_{GE}=30V$	-	-	200	nA
反向栅极体漏电流 Gate-body leakage current, reverse	$I_{GESR}$	$V_{CE}=0V, V_{GE}=-30V$	-	-	-200	nA
<b>通态特性 On-Characteristics</b>						
阈值电压 Gate Threshold Voltage	$V_{TH}$	$V_{CE} = V_{GE}, I_C=250\mu A$	4.5	-	6.5	V
饱和压降 Collector-Emitter saturation Voltage	$V_{CESAT}$	$V_{GE}=15V, I_C=40A, T_C=25^\circ C$	-	1.5	2.2	V
		$V_{GE}=15V, I_C=40A, T_C=175^\circ C$	-	2.1	-	V
<b>动态特性 Dynamic Characteristics</b>						
输入电容 Input capacitance	$C_{ies}$	$V_{CE}=25V, V_{GE}=0V, f=1.0MHz$	-	4604	-	pF
输出电容 Output capacitance	$C_{oes}$		-	200	-	pF
反向传输电容 Reverse transfer capacitance	$C_{res}$		-	49	-	pF
栅极电荷总量 Total Gate Charge	$Q_g$	$V_{CC}=960V, I_C=40A, V_{GE}=15V, T_C=25^\circ C$	-	165	-	nC
栅极-发射极电荷 Gate to emitter charge	$Q_{ge}$		-	46	-	
栅极-集电极电荷 Gate to collector charge	$Q_{gc}$		-	69	-	
栅极电阻-Gate resistance	$R_g$	$f=1MHz$ , open collector	-	2.4	-	$\Omega$
短路电流-short current	$I_{sc}$	$V_{GE}=15V, V_{CE}=600V, t_{sc} < 10\mu s$	-	260	-	A



## 电特性 ELECTRICAL CHARACTERISTICS

开关特性 Switching Characteristics						
项 目 Parameter	符 号 Symbol	测试条件 Tests conditions	最小 Min	典型 Typ	最大 Max	单位 Units
开启延迟时间 Turn-on delay time	$t_d(\text{on})$	$V_{CC}=600V, I_c=40A, R_G=12\Omega$ $V_{GE}=15V$ , Parasitic ductance=75nH $T_C=25^\circ\text{C}$	-	56	-	ns
上升时间 Turn-on rise time	$t_r$		-	98	-	ns
关断延迟时间 Turn-off delay time	$t_d(\text{off})$		-	208	-	ns
下降时间 Turn-off Fall time	$t_f$		-	176	-	ns
开通损耗 Turn-on energy	Eon		-	2.10	-	mJ
关断损耗 Turn-off energy	Eoff		-	2.28	-	mJ
总开关损耗 Total switching energy	Etot		-	4.38	-	mJ
开启延迟时间 Turn-on delay time	$t_d(\text{on})$	$V_{CC}=600V, I_c=40A, R_G=12\Omega$ $V_{GE}=15V$ , Parasitic ductance=75nH $T_C=175^\circ\text{C}$	-	50	-	ns
上升时间 Turn-on rise time	$t_r$		-	98	-	ns
关断延迟时间 Turn-off delay time	$t_d(\text{off})$		-	252	-	ns
下降时间 Turn-off Fall time	$t_f$		-	322	-	ns
开通损耗 Turn-on energy	Eon		-	2.24	-	mJ
关断损耗 Turn-off energy	Eoff		-	3.48	-	mJ
总开关损耗 Total switching energy	Etot		-	5.72	-	mJ
反并联二极管特性及最大额定值 Anti-Parallel Diode Characteristics and Maximum Ratings						
正向压降 Diode Forward Voltage	$V_F$	$V_{GE}=0V, I_F=20A, T_C=25^\circ\text{C}$	-	1.7	2.7	V
		$V_{GE}=0V, I_F=20A, T_C=175^\circ\text{C}$	-	1.5	-	V
反向恢复时间 Diode Reverse recovery time	$t_{rr}$	$V_{GE}=0V, V_R=600V, I_F=40A$ $dl_F/dt=200A/\mu s$ $T_C=25^\circ\text{C}$	-	264	-	ns
反向恢复电荷 Diode Reverse recovery charge	$Q_{rr}$		-	1548	-	nC
反向恢复电流 Diode Reverse recovery Current	$I_{rrm}$		-	9	-	A
反向恢复时间 Diode Reverse recovery time	$t_{rr}$	$V_{GE}=0V, V_R=600V, I_F=40A$ $dl_F/dt=200A/\mu s$ $T_C=175^\circ\text{C}$	-	538	-	ns
反向恢复电荷 Diode Reverse recovery charge	$Q_{rr}$		-	7309	-	nC
反向恢复电流 Diode Reverse recovery Current	$I_{rrm}$		-	24	-	A

项 目 Parameter	符 号 Symbol	MAX	单 位 Unit
		ATT040N120EQ	
结到管壳的热阻 IGBT Thermal Resistance, Junction to Case	$R_{th(j-c)}$	0.23	$^\circ\text{C/W}$
结到环境的热阻 Thermal Resistance, Junction to Ambient	$R_{th(j-A)}$	40	$^\circ\text{C/W}$



特征曲线 ELECTRICAL CHARACTERISTICS (curves)

Output Characteristics (25°C)

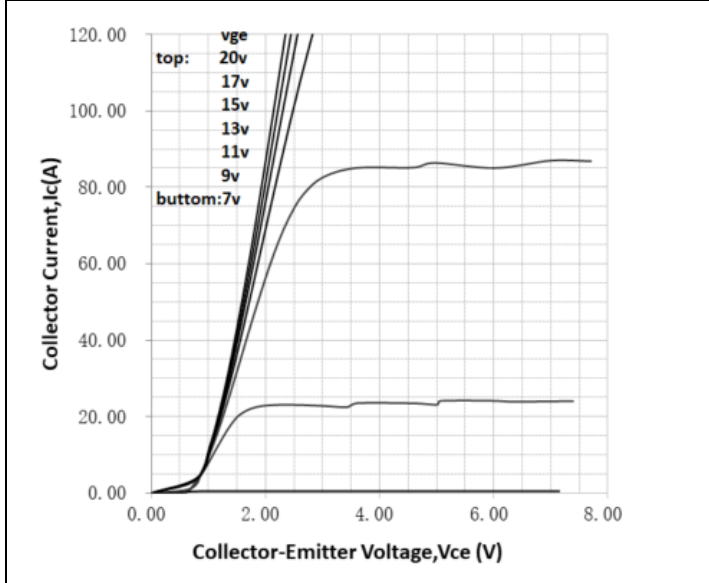

Output Characteristics (175°C)

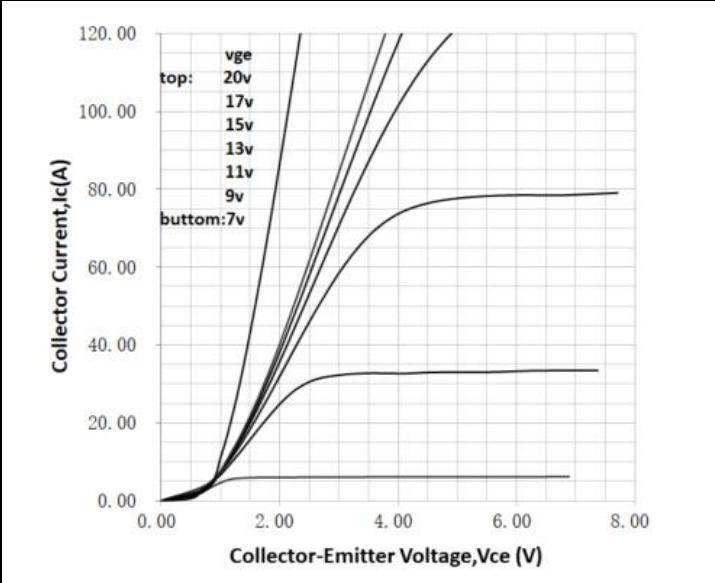

Transfer Characteristics

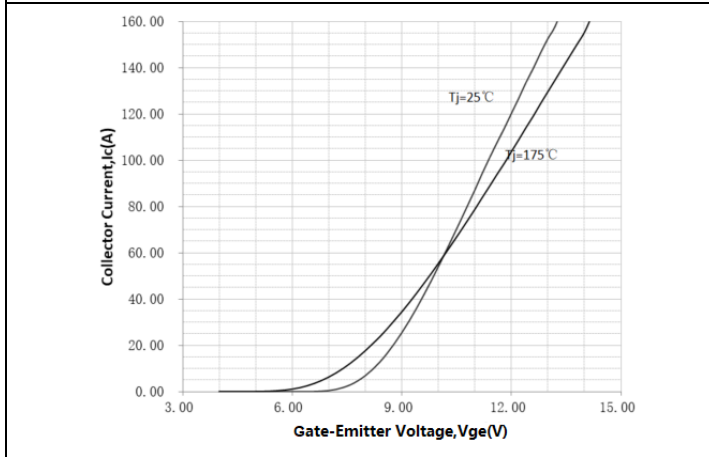

Vcesat vs. Tj

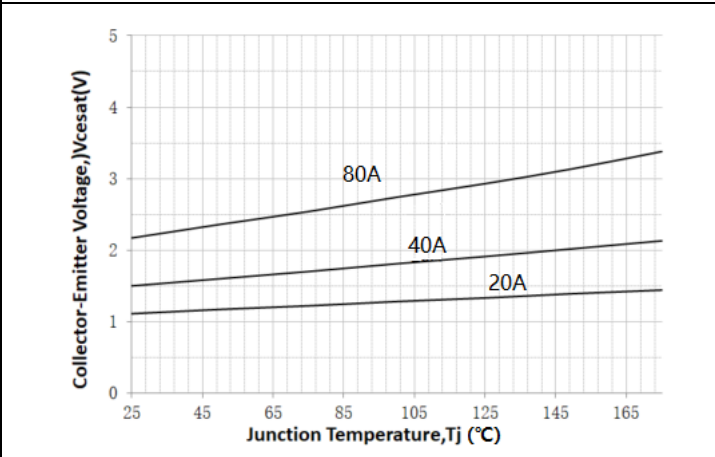

VF vs. Tj

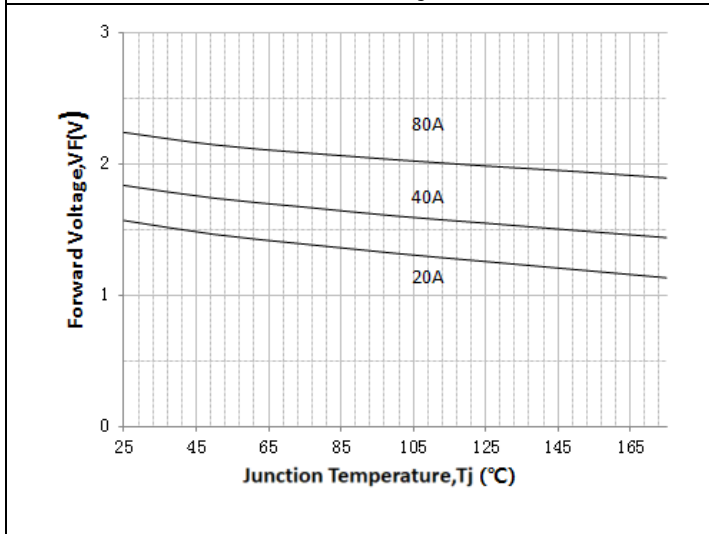

VTH vs. Tj

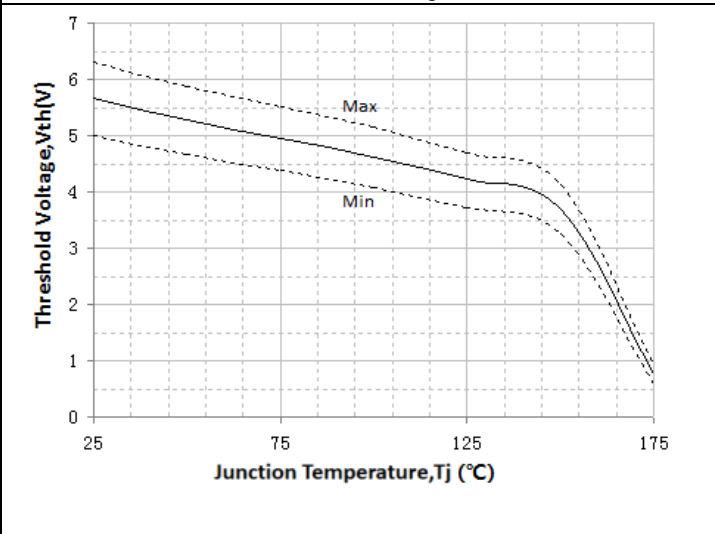



**Diode Characteristic**

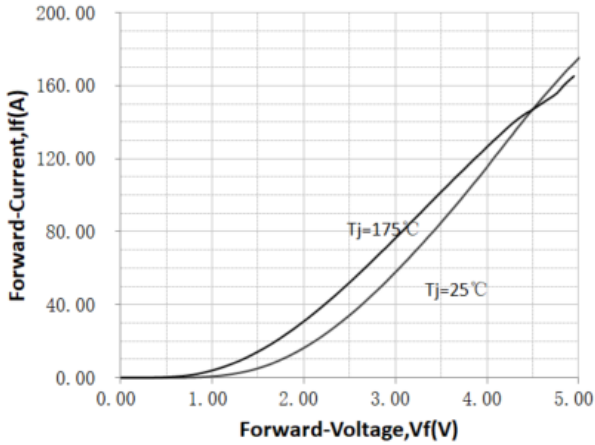

**Collector current vs.case temperature**

VGE≥15V, Tj≤150°C

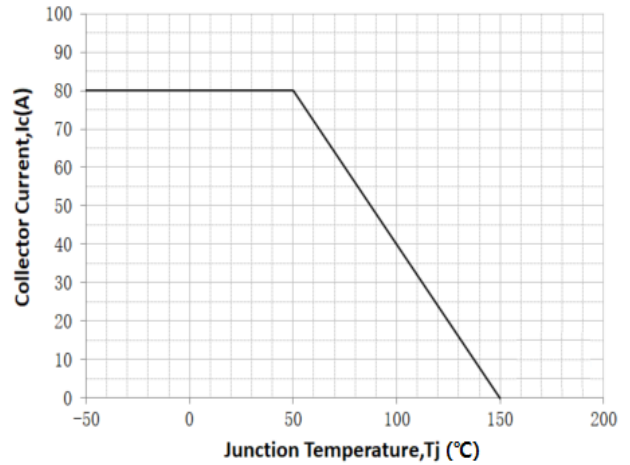

**Gate Charge Characteristics**

VGE=15V, IC=40A

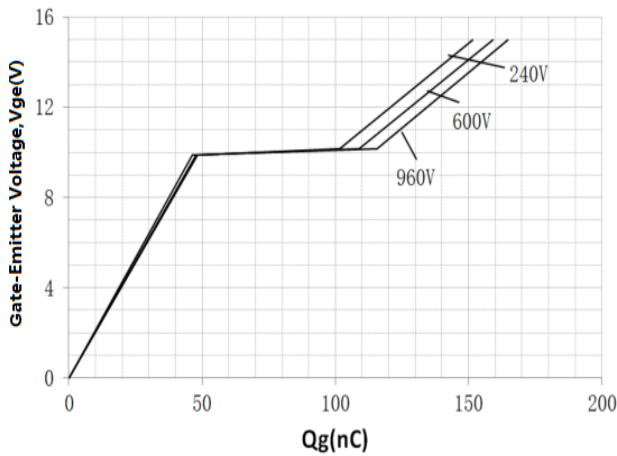

**Capacitance Characteristic**

Vce=25V, VGE =0V, f=1.0MHZ

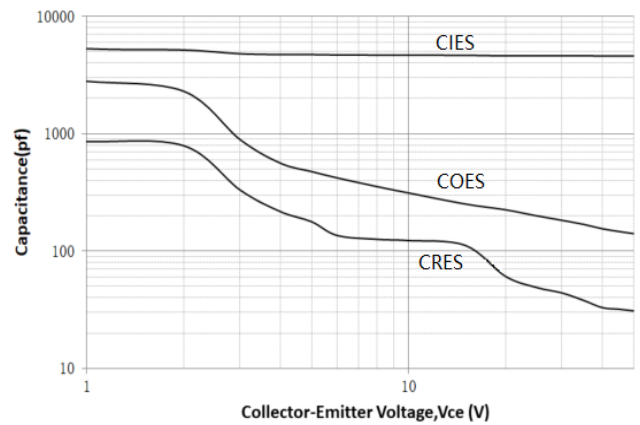

**Switching Time vs. IC(25°C)**

VCC=600V, RG=12Ω, VGE=15V

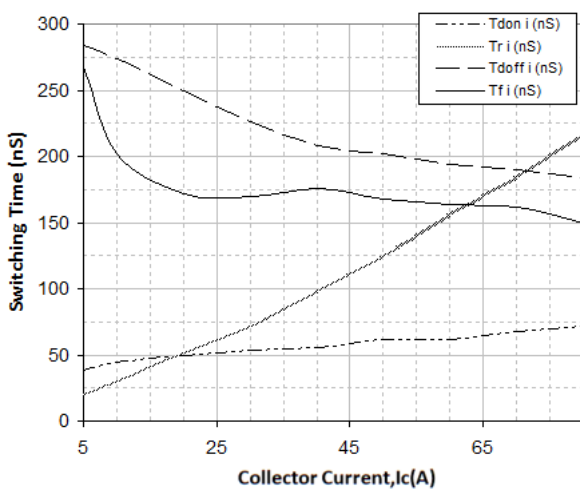

**Switching Time vs. IC(175°C)**

VCC=600V, RG=12Ω, VGE=15V

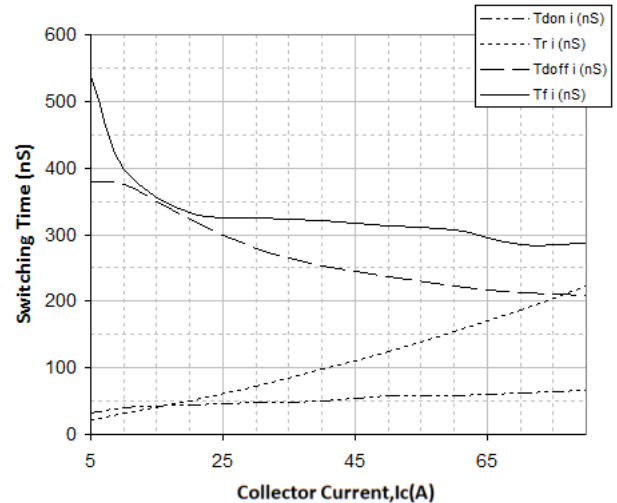



Switching Time vs. Rg(25°C)

VGE=15V, VCE=600V, IC=40A

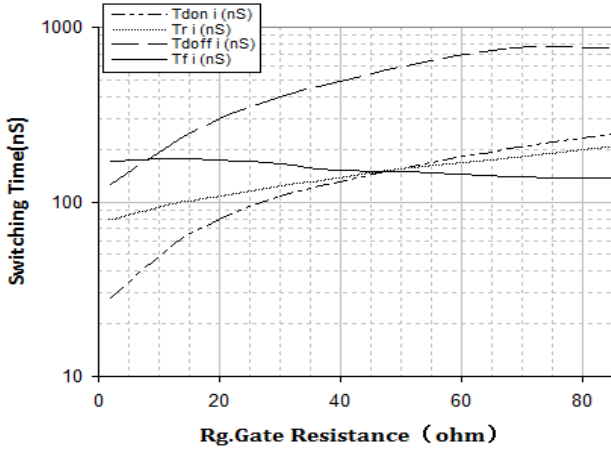

Switching Time vs. Rg(175°C)

VGE=15V, VCE=600V, IC=40A

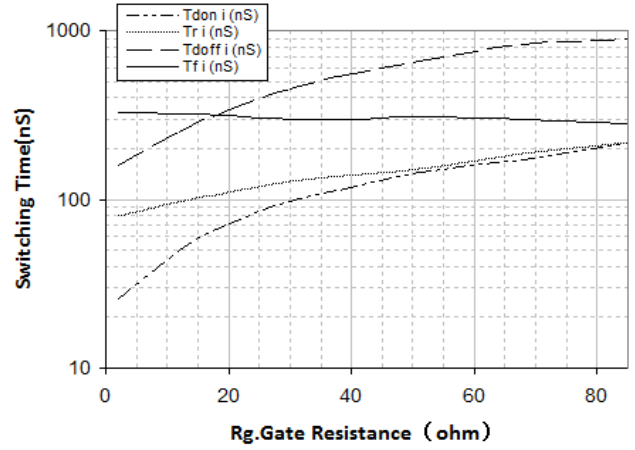

Switching Time vs. Tj

VGE=15V, VCE=600V, IC=40A, Rg=12Ω

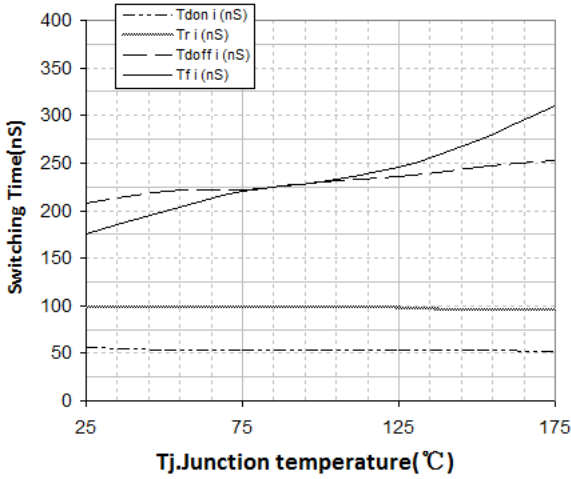

Switching Loss vs. Tj

VGE=15V, VCE=600V, IC=40A, Rg=12Ω

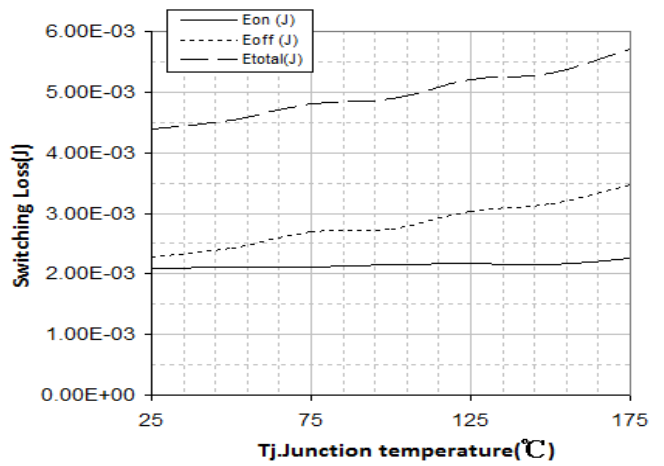

Switching Loss vs. IC(25°C)

VGE=15V, VCE=600V, Rg=12Ω

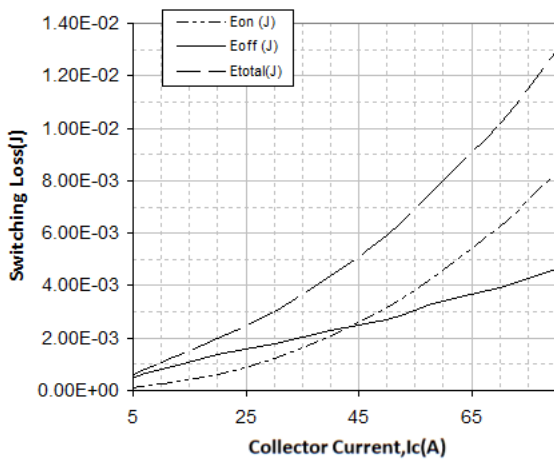

Switching Loss vs. IC(175°C)

VGE=15V, VCE=600V, Rg=12Ω

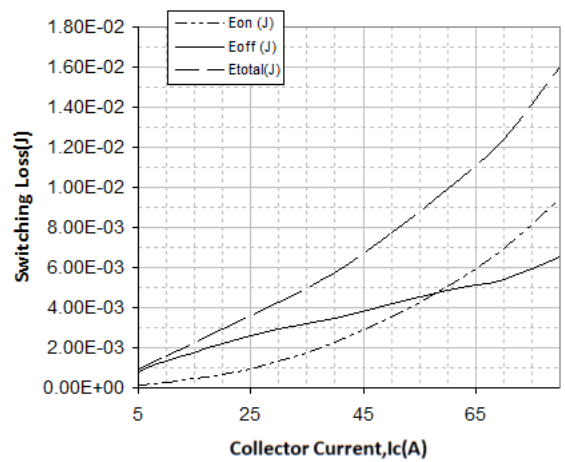



**Switching Loss vs. Rg(25°C)**

VGE=15V, VCE=600V, IC=40A

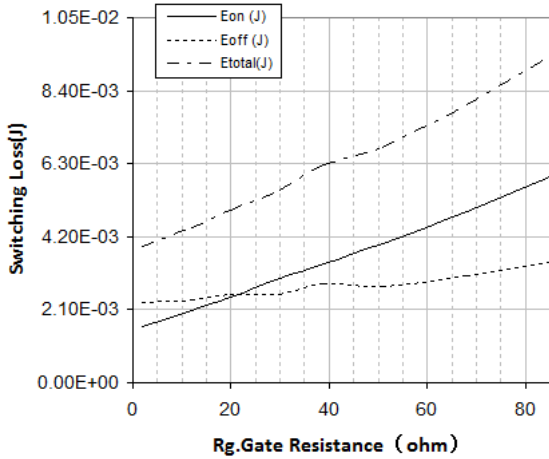

**Switching Loss vs. Rg(175°C)**

VGE=15V, VCE=600V, IC=40A

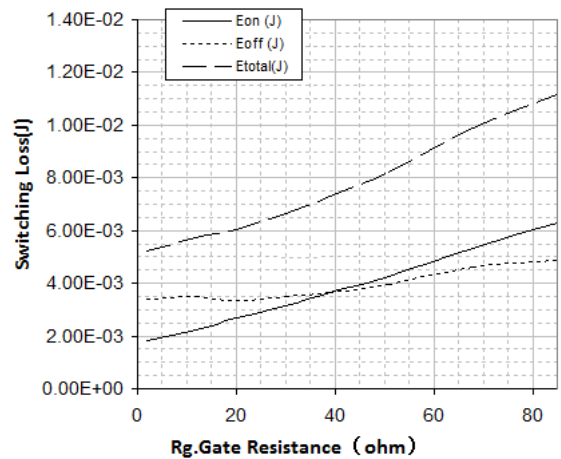

**Switching Loss vs. VCE(25°C)**

VGE=15V, IC=40A, Rg=12Ω

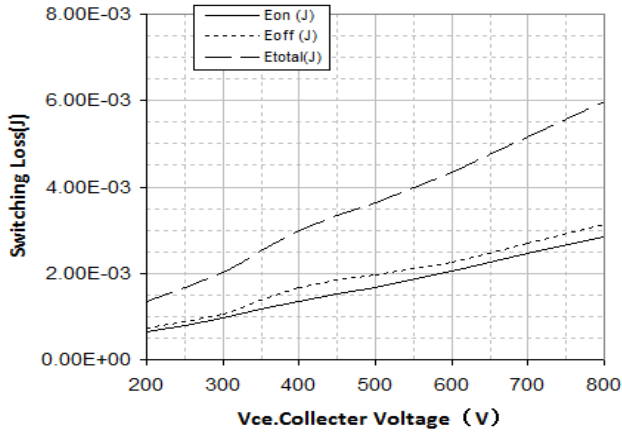

**Switching Loss vs. VCE(175°C)**

VGE=15V, IC=40A, Rg=12Ω

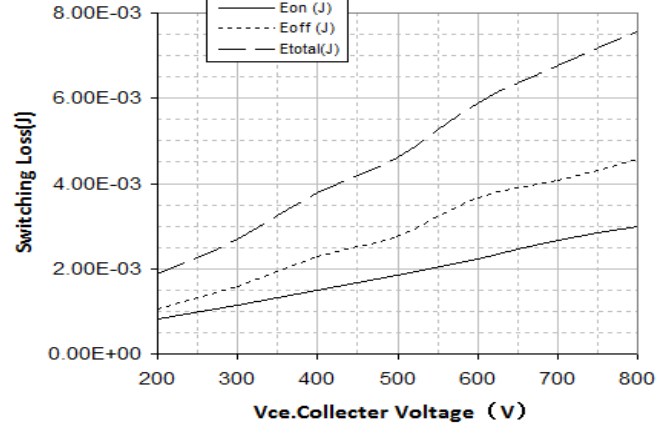

**Forward Bias SOA**

Tc=25°C, VGE=15V, Tj≤150°C

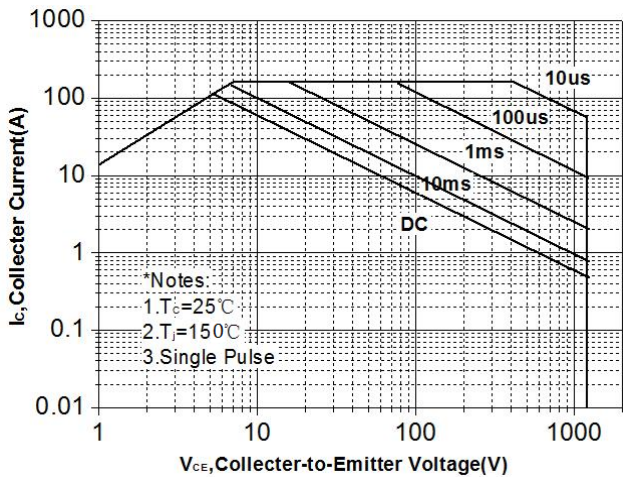

**Normalized Maximum Transient Thermal Impedance for IGBT(RJC)**

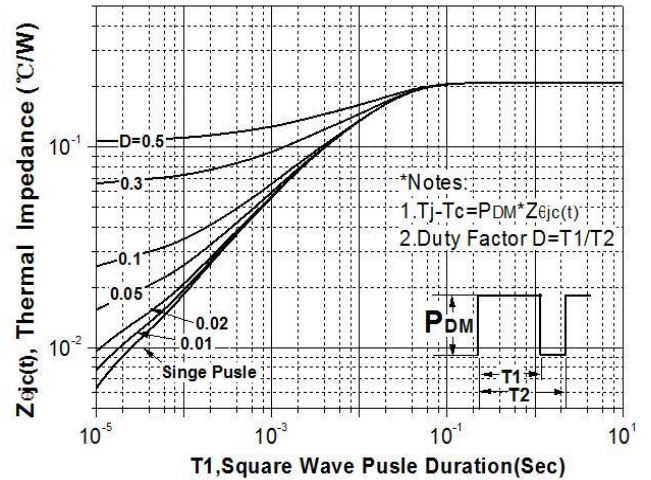



## 外形尺寸 PACKAGE MECHANICAL DATA

TO-247

单位 Unit : mm

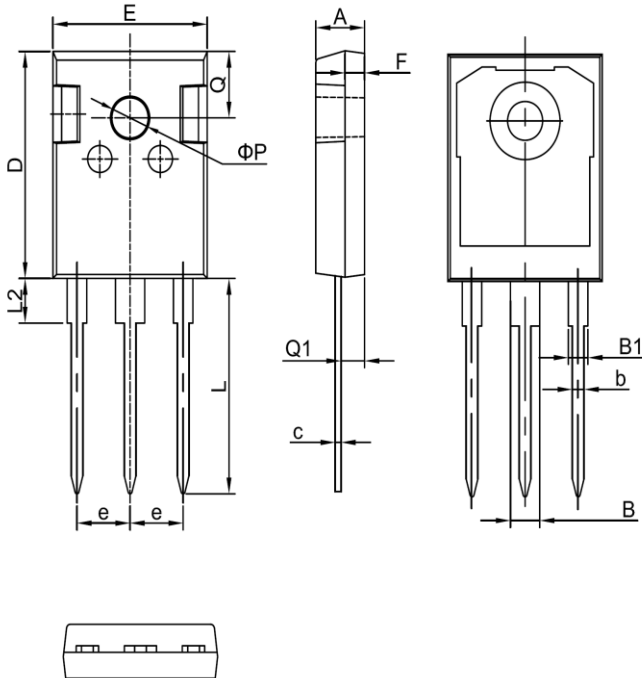

符号 symbol	MIN	MAX
A	4.90	5.10
B	2.95	3.35
B1	1.95	2.35
b	1.15	1.35
c	0.50	0.70
D	20.90	21.10
E	15.70	15.90
e	5.34	5.54
F	1.90	2.10
L	19.40	20.40
L2	4.03	4.23
Q	6.00	6.40
Q1	2.30	2.50
P	3.50	3.70

重点尺寸：b、e、A、D、E。



1. 吉林华微电子股份有限公司的产品销售分为直销和销售代理，无论哪种方式，订货时请与公司核实。
2. 购买时请认清公司商标，如有疑问请与公司本部联系。
3. 在电路设计时请不要超过器件的绝对最大额定值，否则会影响整机的可靠性。
4. 本说明书如有版本变更不另外告知。

## NOTE

1. Jilin Sino-microelectronics co., Ltd sales its product either through direct sales or sales agent , thus, for customers, when ordering , please check with our company.
2. We strongly recommend customers check carefully on the trademark when buying our product, if there is any question, please don't be hesitate to contact us.
3. Please do not exceed the absolute maximum ratings of the device when circuit designing.
4. Jilin Sino-microelectronics co., Ltd reserves the right to make changes in this. specification sheet and is subject to change without prior notice.

## 联系方式

### 吉林华微电子股份有限公司

公司地址：吉林省吉林市深圳街 99 号

邮编：132013

总机：86-432-64678411

传真：86-432-64665812

网址：[www.hwdz.com.cn](http://www.hwdz.com.cn)

## CONTACT

### JILIN SINO-MICROELECTRONICS CO., LTD.

ADD: No.99 Shenzhen Street, Jilin City, Jilin Province, China.

Post Code: 132013

Tel: 86-432-64678411

Fax: 86-432-64665812

Web Site: [www.hwdz.com.cn](http://www.hwdz.com.cn)