

MOSFET - Power, Single N-Channel, Source Down, WDFN9

40 V, 2.1 mΩ, 150 A
NTTFSS002N04HL

Features

- Advanced Source-Down Package Technology (3.3x3.3mm) with Excellent Thermal Conduction
- Ultra Low $R_{DS(on)}$ to Improve System Efficiency
- Low Q_G and Capacitance to Minimize Driving and Switching Losses
- These Devices are Pb-Free, Halogen Free/BFR Free and are RoHS Compliant

Typical Applications

- DC-DC Switching Applications
- ORing Applications
- Power Load Switch
- Battery Management and Protection

MAXIMUM RATINGS ($T_J = 25^\circ\text{C}$ unless otherwise noted)

Parameter		Symbol	Value	Unit	
Drain-to-Source Voltage		V_{DSS}	40	V	
Gate-to-Source Voltage		V_{GS}	± 20	V	
Continuous Drain Current $R_{\theta JC}$ (Note 1)	Steady State	$T_C = 25^\circ\text{C}$	I_D	150	A
		$T_C = 85^\circ\text{C}$		107	
Power Dissipation $R_{\theta JC}$ (Note 1)	Steady State	$T_C = 25^\circ\text{C}$	P_D	84	W
Continuous Drain Current $R_{\theta JA}$ (Notes 1, 2)	Steady State	$T_A = 25^\circ\text{C}$	I_D	23	A
		$T_A = 85^\circ\text{C}$		16	
Power Dissipation $R_{\theta JA}$ (Notes 1, 2)	Steady State	$T_A = 25^\circ\text{C}$	P_D	2	W
Pulsed Drain Current	$T_A = 25^\circ\text{C}, t_p = 10 \mu\text{s}$	I_{DM}	900	A	
Single Pulse Drain-to-Source Avalanche Energy ($I_{L(pk)} = 49 \text{ A}, L = 0.1 \text{ mH}$)		E_{AS}	96	mJ	
Operating Junction and Storage Temperature Range		T_J, T_{stg}	-55 to +150	$^\circ\text{C}$	
Lead Temperature Soldering Reflow for Soldering Purposes (1/8" from case for 10 s)		T_L	260	$^\circ\text{C}$	

Stresses exceeding those listed in the Maximum Ratings table may damage the device. If any of these limits are exceeded, device functionality should not be assumed, damage may occur and reliability may be affected.

1. The entire application environment impacts the thermal resistance values shown, they are not constants and are valid for the particular conditions noted.
2. Surface-mounted on FR4 board using a 1 in² pad size, 1 oz Cu pad.

$V_{(BR)DSS}$	$R_{DS(ON)} \text{ MAX}$	$I_D \text{ MAX}$
40 V	2.1 mΩ @ 10 V	150 A
	3.1 mΩ @ 4.5 V	

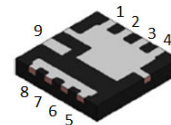
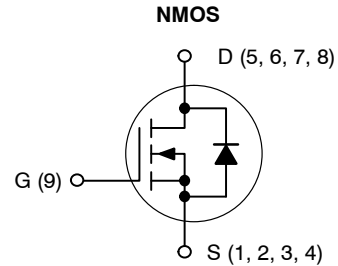

WDFN9
CASE 511EB

MARKING DIAGRAM

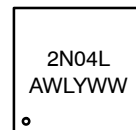

2N04L = Specific Device Code
A = Assembly Location
WL = Wafer Lot
Y = Year
WW = Work Week

ORDERING INFORMATION

See detailed ordering and shipping information on page 5 of this data sheet.

NTTFSS002N04HL

THERMAL RESISTANCE RATINGS

Parameter	Symbol	Max	Unit
Junction-to-Case – Steady State (Note 1)	$R_{\theta JC}$	1.48	°C/W
Junction-to-Ambient – Steady State (Note 1, 2)	$R_{\theta JA}$	60	

ELECTRICAL CHARACTERISTICS ($T_J = 25^\circ\text{C}$ unless otherwise specified)

Parameter	Symbol	Test Condition	Min	Typ	Max	Unit
OFF CHARACTERISTICS						
Drain-to-Source Breakdown Voltage	$V_{(BR)DSS}$	$V_{GS} = 0\text{ V}, I_D = 250\ \mu\text{A}$	40			V
Drain-to-Source Breakdown Voltage Temperature Coefficient	$V_{(BR)DSS}/T_J$	$I_D = 250\ \mu\text{A}$, ref to 25°C		8		mV/°C
Zero Gate Voltage Drain Current	I_{DSS}	$V_{GS} = 0\text{ V}, V_{DS} = 32\text{ V}$			10	μA
		$T_J = 125^\circ\text{C}$			100	
Gate-to-Source Leakage Current	I_{GSS}	$V_{DS} = 0\text{ V}, V_{GS} = 20\text{ V}$			100	nA

ON CHARACTERISTICS (Note 3)

Gate Threshold Voltage	$V_{GS(TH)}$	$V_{GS} = V_{DS}, I_D = 120\ \mu\text{A}$	1.2		2.0	V
Threshold Temperature Coefficient	$V_{GS(TH)}/T_J$	$I_D = 120\ \mu\text{A}$, ref to 25°C		-5.6		mV/°C
Drain-to-Source On Resistance	$R_{DS(on)}$	$V_{GS} = 10\text{ V}, I_D = 23\text{ A}$		1.77	2.10	m Ω
		$V_{GS} = 4.5\text{ V}, I_D = 18\text{ A}$		2.52	3.10	
Gate Resistance	R_G	$T_A = 25^\circ\text{C}$		0.85		Ω

CHARGES & CAPACITANCES

Input Capacitance	C_{ISS}	$V_{GS} = 0\text{ V}, V_{DS} = 20\text{ V}, f = 1\text{ MHz}$		2760		pF
Output Capacitance	C_{OSS}			655		
Reverse Capacitance	C_{RSS}			43		
Total Gate Charge	$Q_{G(TOT)}$	$V_{GS} = 4.5\text{ V}, V_{DS} = 20\text{ V}; I_D = 18\text{ A}$		20.3		nC
Threshold Gate Charge	$Q_{G(TH)}$			2.5		
Gate-to-Drain Charge	Q_{GD}			8.4		
Gate-to-Source Charge	Q_{GS}			6.0		
Total Gate Charge	$Q_{G(TOT)}$	$V_{GS} = 10\text{ V}, V_{DS} = 20\text{ V}; I_D = 18\text{ A}$		43		

SWITCHING CHARACTERISTICS, $V_{GS} = 10\text{ V}$ (Note 3)

Turn-On Delay Time	$t_{d(ON)}$	$V_{GS} = 10\text{ V}, V_{DD} = 20\text{ V}, I_D = 23\text{ A}, R_G = 2.5\ \Omega$		12.6		ns
Rise Time	t_r			10		
Turn-Off Delay Time	$t_{d(OFF)}$			36.6		
Fall Time	t_f			6.8		

SOURCE-TO-DRAIN DIODE CHARACTERISTICS

Forward Diode Voltage	V_{SD}	$V_{GS} = 0\text{ V}, I_S = 23\text{ A}$	$T_J = 25^\circ\text{C}$	0.78	1.2	V
			$T_J = 125^\circ\text{C}$	0.63		
Reverse Recovery Time	t_{RR}	$V_{GS} = 0\text{ V}, di/dt = 100\text{ A}/\mu\text{s}, I_S = 23\text{ A}$		35.8		ns
Reverse Recovery Charge	Q_{RR}			26.6		nC

Product parametric performance is indicated in the Electrical Characteristics for the listed test conditions, unless otherwise noted. Product performance may not be indicated by the Electrical Characteristics if operated under different conditions.

3. Switching characteristics are independent of operating junction temperatures.

TYPICAL CHARACTERISTICS

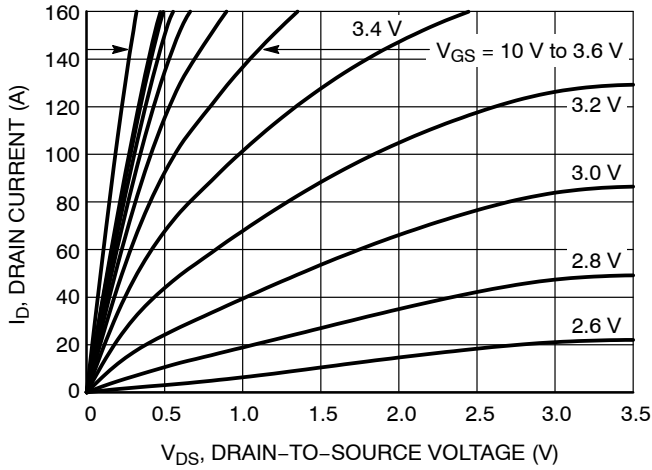

Figure 1. On-Region Characteristics

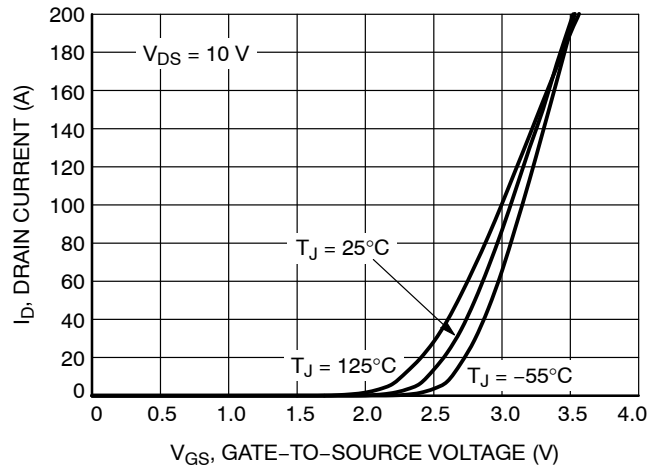

Figure 2. Transfer Characteristics

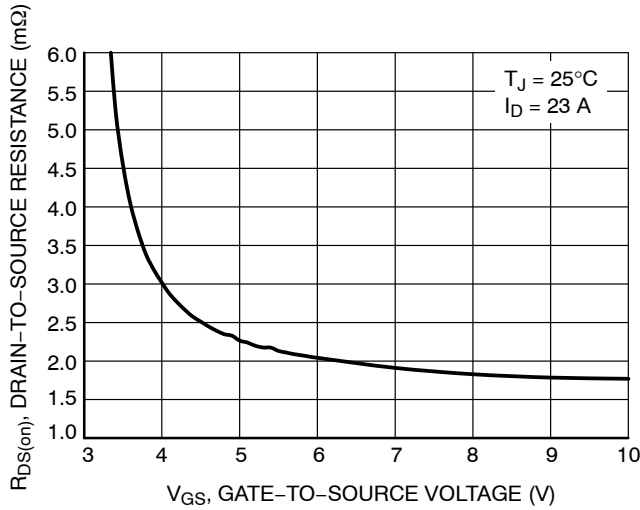

Figure 3. On-Resistance vs. Gate-to-Source Voltage

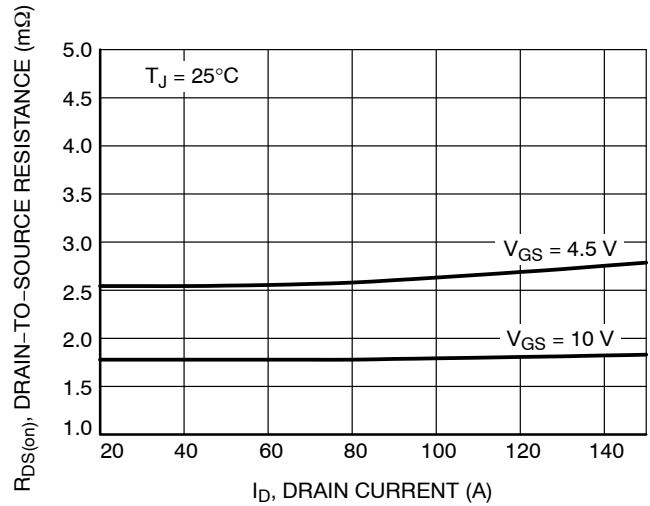

Figure 4. On-Resistance vs. Drain Current and Gate Voltage

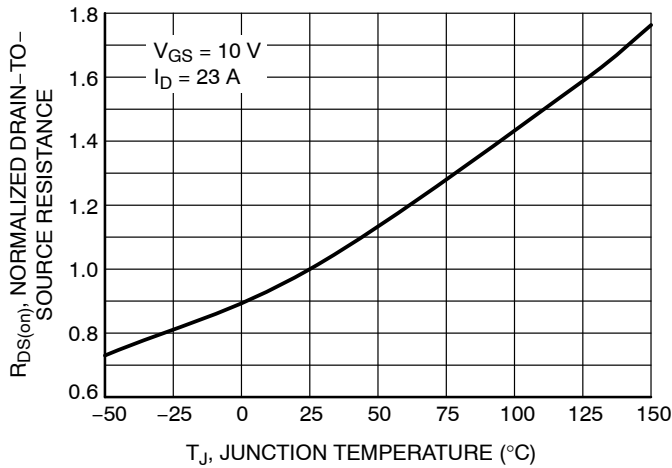

Figure 5. On-Resistance Variation with Temperature

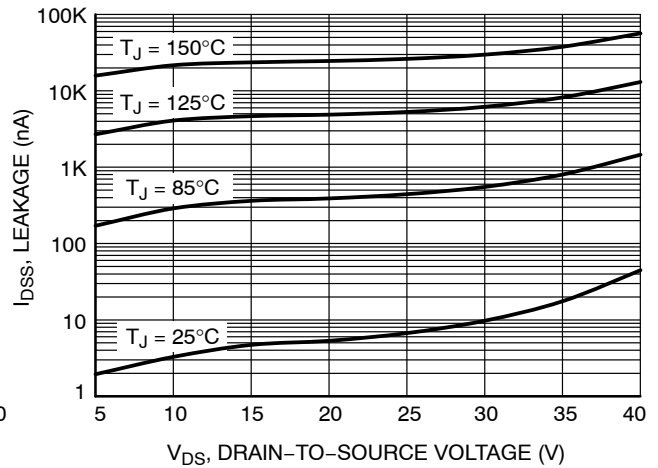

Figure 6. Drain-to-Source Leakage Current vs. Voltage

TYPICAL CHARACTERISTICS

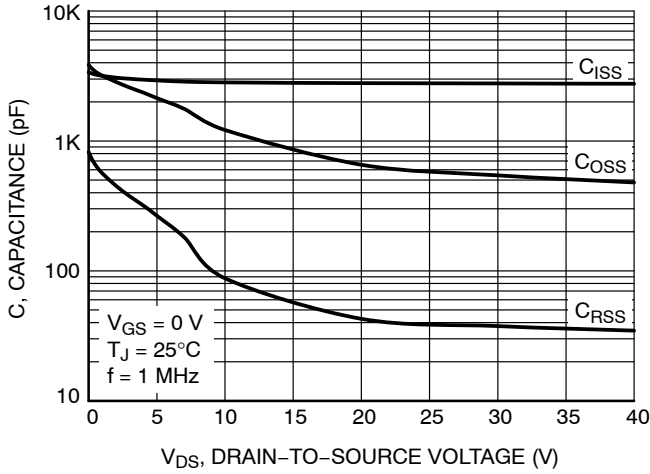

Figure 7. Capacitance Variation

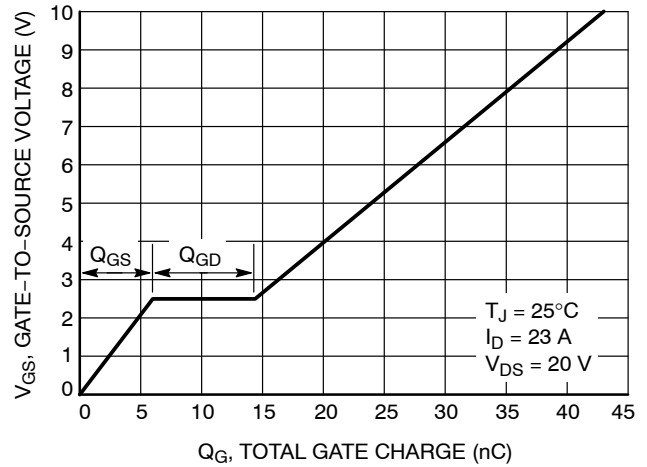

Figure 8. Gate-to-Source Voltage vs. Total Charge

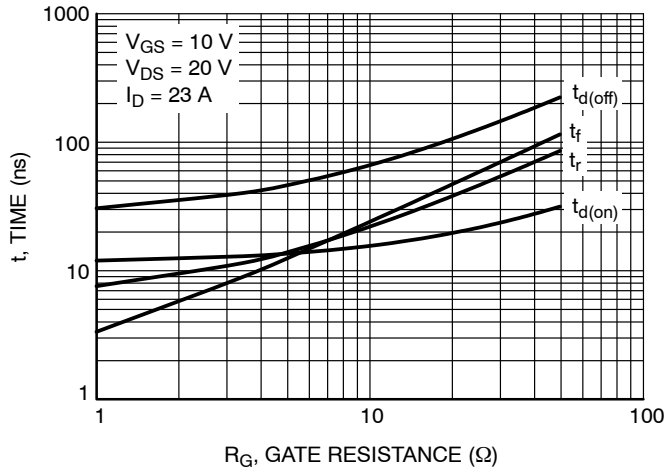

Figure 9. Resistive Switching Time Variation vs. Gate Resistance

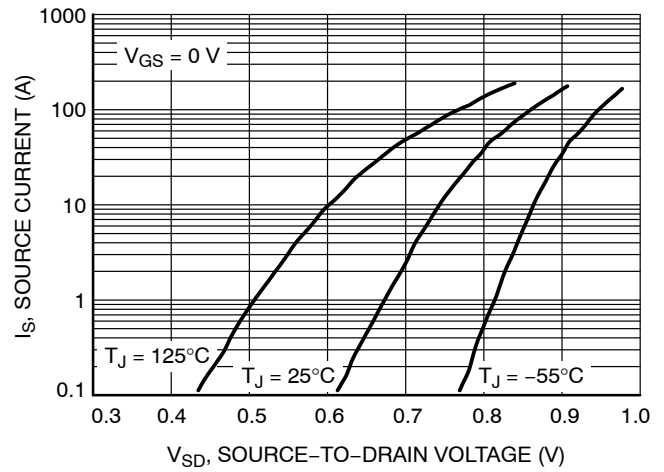

Figure 10. Diode Forward Voltage vs. Current

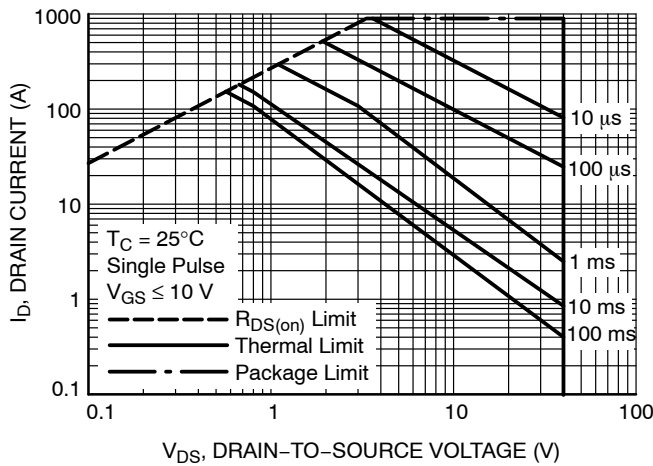

Figure 11. Maximum Rated Forward Biased Safe Operating Area

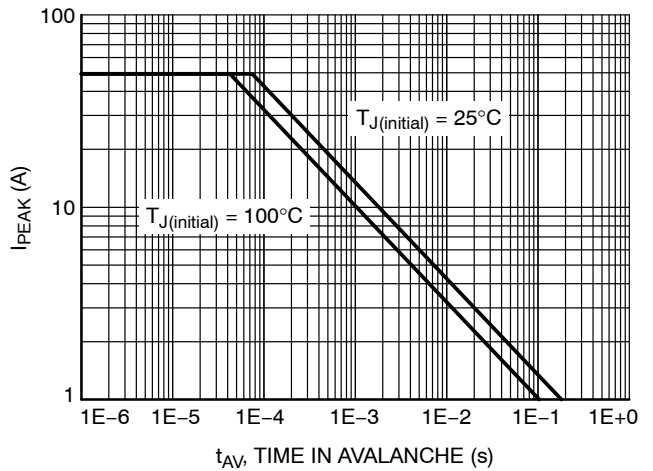

Figure 12. Maximum Drain Current vs. Time in Avalanche

NTTFSS002N04HL

TYPICAL CHARACTERISTICS

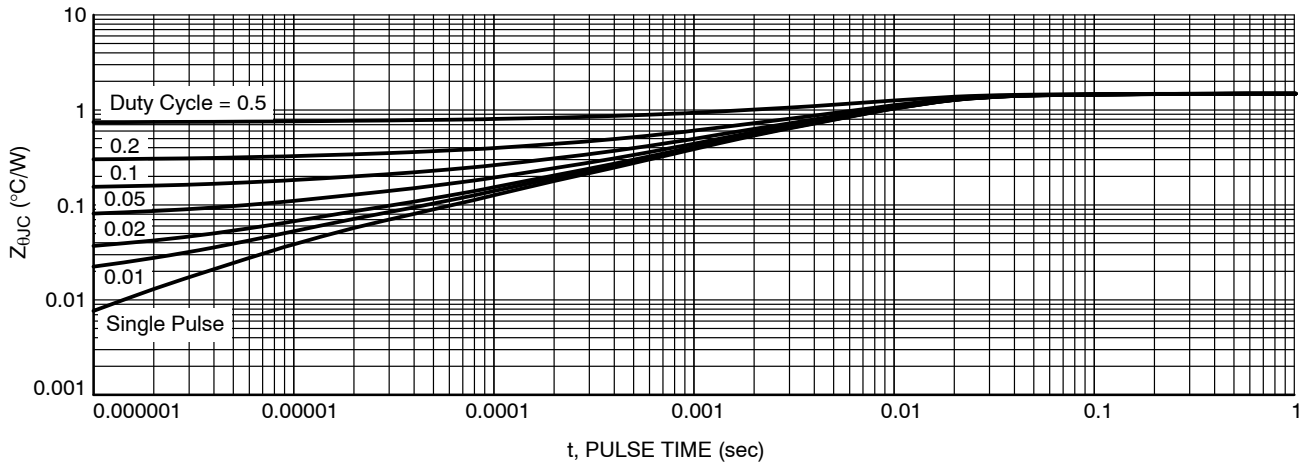

Figure 13. Transient Thermal Impedance

ORDERING INFORMATION

Device	Marking	Package	Shipping [†]
NTTFSS002N04HL	2N04L	WDFN9 (Pb-Free)	3000 / Tape & Reel

[†]For information on tape and reel specifications, including part orientation and tape sizes, please refer to our Tape and Reel Packaging Specifications Brochure, BRD8011/D.

NTTFSS002N04HL

PACKAGE DIMENSIONS

WDFN9 3.3x3.3, 0.65P
CASE 511EB
ISSUE B

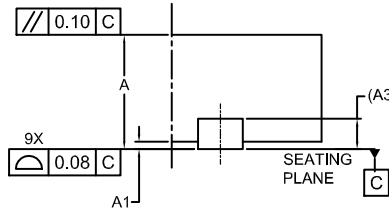
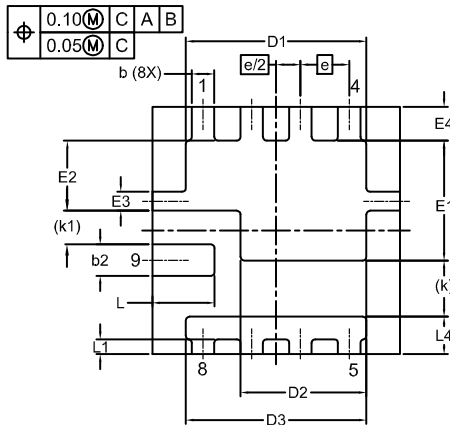
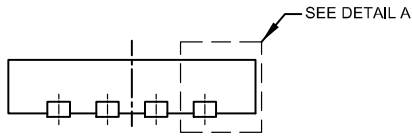
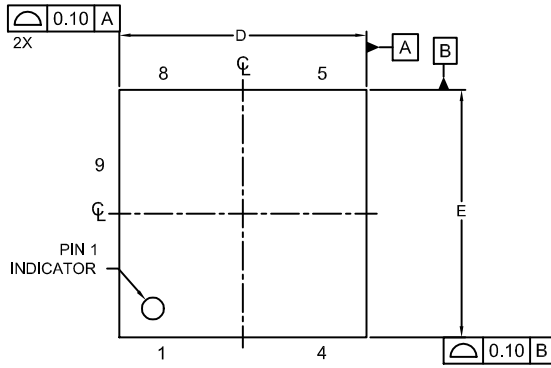

SCALE: 2:1

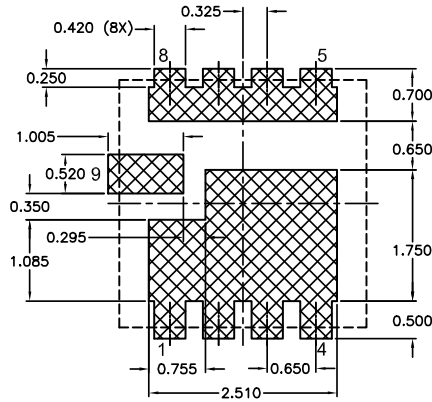

NOTES:

1. CONTROLLING DIMENSION: MILLIMETERS
2. COPLANARITY APPLIES TO THE EXPOSED PADS AS WELL AS THE TERMINALS.
3. DIMENSIONS D1, D2, E1 AND E2 DO NOT INCLUDE MOLD FLASH.
4. SEATING PLANE IS DEFINED BY THE TERMINALS. "A1" IS DEFINED AS THE DISTANCE FROM THE SEATING PLANE TO THE LOWEST POINT OF THE PACKAGE BODY.

UNIT IN MILLIMETER			
DIM	MIN	NOM	MAX
A	0.70	0.75	0.80
A1	0.00	0.02	0.05
A3	0.20 REF		
b	0.25	0.30	0.35
b2	0.37	0.42	0.47
D	3.20	3.30	3.40
D1	2.31	2.41	2.51
D2	1.58	1.68	1.78
D3	2.31	2.41	2.51
E	3.20	3.30	3.40
E1	1.50	1.60	1.70
E2	0.84	0.94	1.04
E3	0.20	0.25	0.30
E4	0.35	0.45	0.55
e	0.650 BSC		
e/2	0.325 BSC		
k	0.75 REF		
k1	0.45 REF		
L	0.73	0.83	0.93
L1	0.10	0.20	0.30
L4	0.40	0.50	0.60

*FOR ADDITIONAL INFORMATION ON OUR PB-FREE STRATEGY AND SOLDERING DETAILS, PLEASE DOWNLOAD THE ON SEMICONDUCTOR SOLDERING AND MOUNTING TECHNIQUES REFERENCE MANUAL, SOLDERRM/D.

onsemi, **Onsemi**, and other names, marks, and brands are registered and/or common law trademarks of Semiconductor Components Industries, LLC dba "**onsemi**" or its affiliates and/or subsidiaries in the United States and/or other countries. **onsemi** owns the rights to a number of patents, trademarks, copyrights, trade secrets, and other intellectual property. A listing of **onsemi**'s product/patent coverage may be accessed at www.onsemi.com/site/pdf/Patent-Marking.pdf. **onsemi** reserves the right to make changes at any time to any products or information herein, without notice. The information herein is provided "as-is" and **onsemi** makes no warranty, representation or guarantee regarding the accuracy of the information, product features, availability, functionality, or suitability of its products for any particular purpose, nor does **onsemi** assume any liability arising out of the application or use of any product or circuit, and specifically disclaims any and all liability, including without limitation special, consequential or incidental damages. Buyer is responsible for its products and applications using **onsemi** products, including compliance with all laws, regulations and safety requirements or standards, regardless of any support or applications information provided by **onsemi**. "Typical" parameters which may be provided in **onsemi** data sheets and/or specifications can and do vary in different applications and actual performance may vary over time. All operating parameters, including "Typicals" must be validated for each customer application by customer's technical experts. **onsemi** does not convey any license under any of its intellectual property rights nor the rights of others. **onsemi** products are not designed, intended, or authorized for use as a critical component in life support systems or any FDA Class 3 medical devices or medical devices with a same or similar classification in a foreign jurisdiction or any devices intended for implantation in the human body. Should Buyer purchase or use **onsemi** products for any such unintended or unauthorized application, Buyer shall indemnify and hold **onsemi** and its officers, employees, subsidiaries, affiliates, and distributors harmless against all claims, costs, damages, and expenses, and reasonable attorney fees arising out of, directly or indirectly, any claim of personal injury or death associated with such unintended or unauthorized use, even if such claim alleges that **onsemi** was negligent regarding the design or manufacture of the part. **onsemi** is an Equal Opportunity/Affirmative Action Employer. This literature is subject to all applicable copyright laws and is not for resale in any manner.

PUBLICATION ORDERING INFORMATION

LITERATURE FULFILLMENT:

Email Requests to: orderlit@onsemi.com

onsemi Website: www.onsemi.com

TECHNICAL SUPPORT

North American Technical Support:

Voice Mail: 1 800-282-9855 Toll Free USA/Canada

Phone: 011 421 33 790 2910

Europe, Middle East and Africa Technical Support:

Phone: 00421 33 790 2910

For additional information, please contact your local Sales Representative