

P-Channel Enhancement Mode Power MOSFET

Description

The RM4P20ES6 uses advanced trench technology to provide excellent $R_{DS(ON)}$, low gate charge and operation with gate voltages as low as 2.5V. This device is suitable for use as a load switch or in PWM applications.

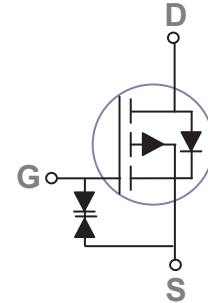

Schematic diagram

General Features

- $V_{DS} = -20V, I_D = -4.1A$
 $R_{DS(ON)} < 80m\Omega @ V_{GS} = -2.5V$
 $R_{DS(ON)} < 52m\Omega @ V_{GS} = -4.5V$
- ESD: HBM > 2000V
- High power and current handling capability
- Lead free product is acquired
- Surface mount package

Application

- PWM applications
- Load switch
- Power management
- Halogen-free

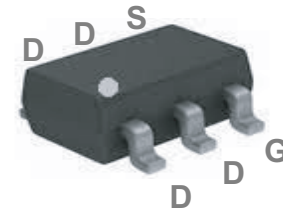

SOT23-6 top view

Package Marking and Ordering Information

Device Marking	Device	Device Package	Reel Size	Tape width	Quantity
4P20	RM4P20ES6	SOT23-6	Ø180mm	8 mm	3000 units

Absolute Maximum Ratings ($T_A = 25$ unless otherwise noted)

Parameter	Symbol	Limit	Unit
Drain-Source Voltage	V_{DS}	-20	V
Gate-Source Voltage	V_{GS}	±12	V
Continuous Drain Current	I_D	$T_C = 25^\circ C$	-4.1
		$T_C = 70^\circ C$	-3.2
		$T_A = 25^\circ C$	-3
		$T_A = 70^\circ C$	-2.3
Drain Current - Pulsed (Note 1)	I_{DM}	-15	A
Maximum Power Dissipation	P_D	1.7	W
Operating Junction and Storage Temperature Range	T_J, T_{STG}	-55 To 150	$^\circ C$

Thermal Characteristic

Thermal Resistance, Junction-to-Ambient (Note 2)	$R_{\theta JA}$	74	$^\circ C/W$
--	-----------------	----	--------------

Electrical Characteristics (T_A=25°C unless otherwise noted)

Parameter	Symbol	Condition	Min	Typ	Max	Unit
Off Characteristics						
Drain-Source Breakdown Voltage	BV _{DSS}	V _{GS} =0V, I _D =-250μA	-20	-	-	V
Zero Gate Voltage Drain Current	I _{DSS}	V _{DS} =-20V, V _{GS} =0V	-	-	-1	μA
Gate-Body Leakage Current	I _{GSS}	V _{GS} =±12V, V _{DS} =0V	-	-	±100	nA
On Characteristics (Note 3)						
Gate Threshold Voltage	V _{GS(th)}	V _{DS} =V _{GS} , I _D =-250μA	-0.45	-0.7	-1.0	V
Drain-Source On-State Resistance	R _{DS(ON)}	V _{GS} =-4.5V, I _D =-4.1A	-	39	52	mΩ
		V _{GS} =-2.5V, I _D =-3.6A	-	60	80	
Forward Transconductance	g _{FS}	V _{DS} =-5V, I _D =-2A	6	-	-	S
Dynamic Characteristics (Note4)						
Input Capacitance	C _{ISS}	V _{DS} =-4V, V _{GS} =0V, F=1.0MHz	-	740	-	PF
Output Capacitance	C _{OSS}		-	290	-	PF
Reverse Transfer Capacitance	C _{RSS}		-	190	-	PF
Switching Characteristics (Note 4)						
Turn-on Delay Time	t _{d(on)}	V _{DD} =-4V, I _D =-3.3A , R _L =-1.2Ω, V _{GEN} =-4.5V, R _g =1Ω	-	12	-	nS
Turn-on Rise Time	t _r		-	35	-	nS
Turn-Off Delay Time	t _{d(off)}		-	30	-	nS
Turn-Off Fall Time	t _f		-	10	-	nS
Total Gate Charge	Q _g	V _{DS} =-4V, I _D =-4.1A, V _{GS} =-4.5V	-	7.8	-	nC
Gate-Source Charge	Q _{gs}		-	1.2	-	nC
Gate-Drain Charge	Q _{gd}		-	1.6	-	nC
Drain-Source Diode Characteristics						
Diode Forward Voltage (Note 3)	V _{SD}	V _{GS} =0V, I _S =-1.6A	-	-	-1.2	V
Diode Forward Current (Note 2)	I _S		-	-	1.6	A

Notes:

1. Repetitive Rating: Pulse width limited by maximum junction temperature.
2. Surface Mounted on FR4 Board, t ≤ 10 sec.
3. Pulse Test: Pulse Width ≤ 300μs, Duty Cycle ≤ 2%.
4. Guaranteed by design, not subject to production

RATING AND CHARACTERISTICS CURVES (RM4P20ES6)

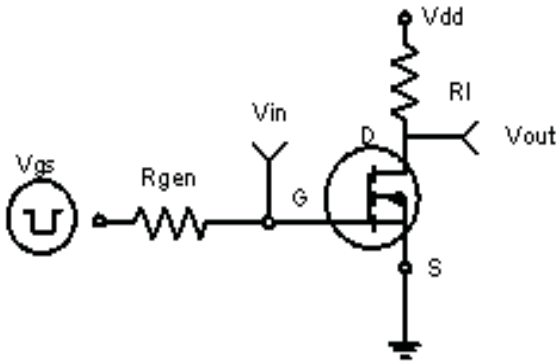

Figure 1: Switching Test Circuit

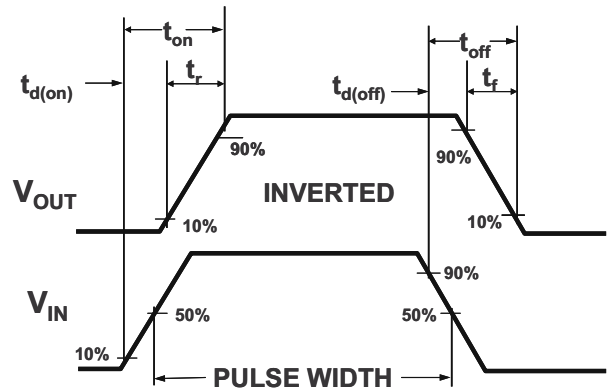
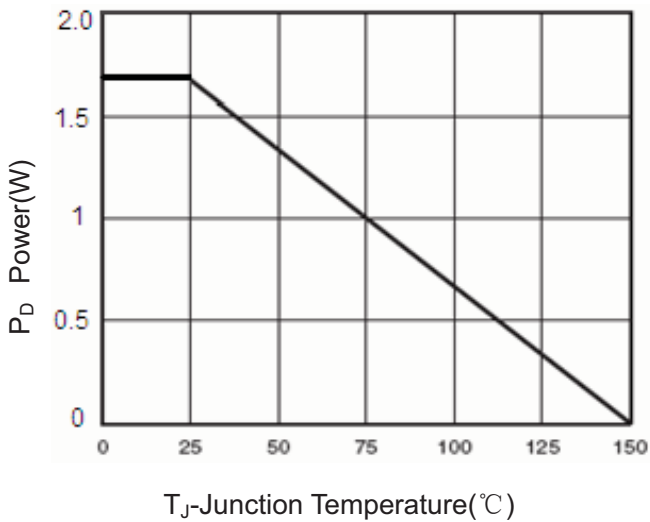
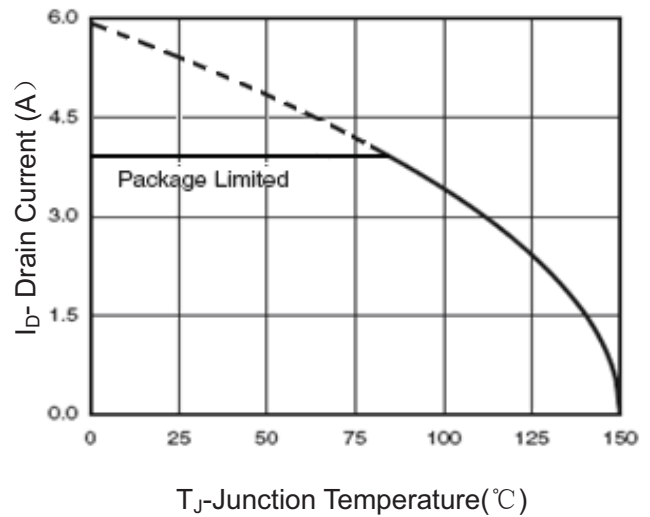

Figure 2: Switching Waveforms



T_J-Junction Temperature(°C)
Figure 3 Power Dissipation



T_J-Junction Temperature(°C)
Figure 4 Drain Current

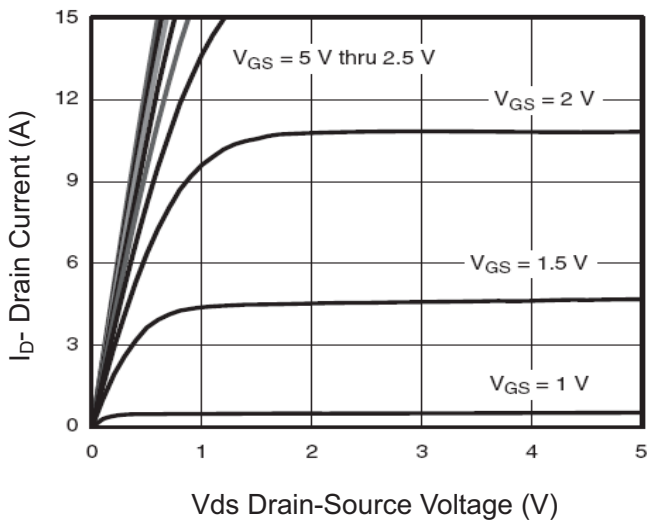

V_{ds} Drain-Source Voltage (V)
Figure 5 Output Characteristics

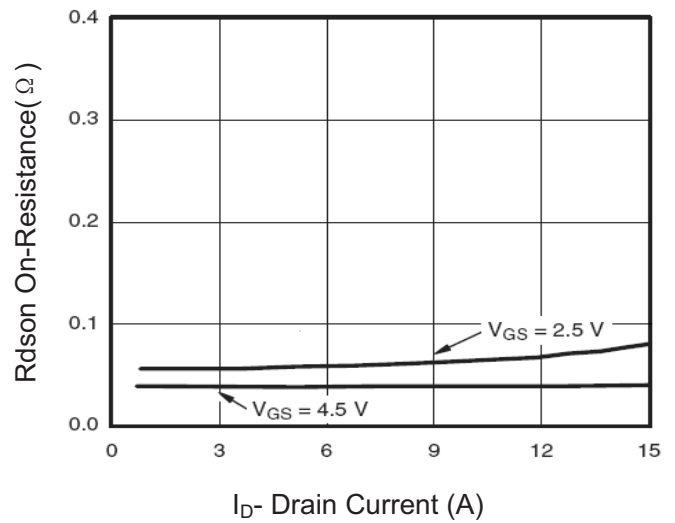

I_D- Drain Current (A)
Figure 6 Drain-Source On-Resistance

RATING AND CHARACTERISTICS CURVES (RM4P20ES6)

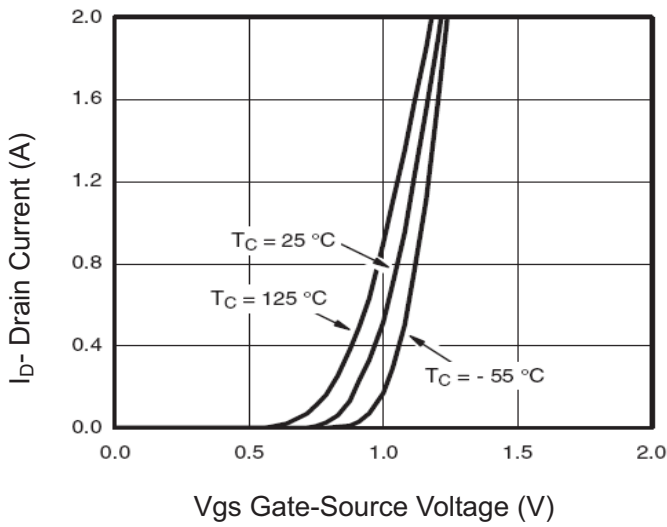

Vgs Gate-Source Voltage (V)
Figure 7 Transfer Characteristics

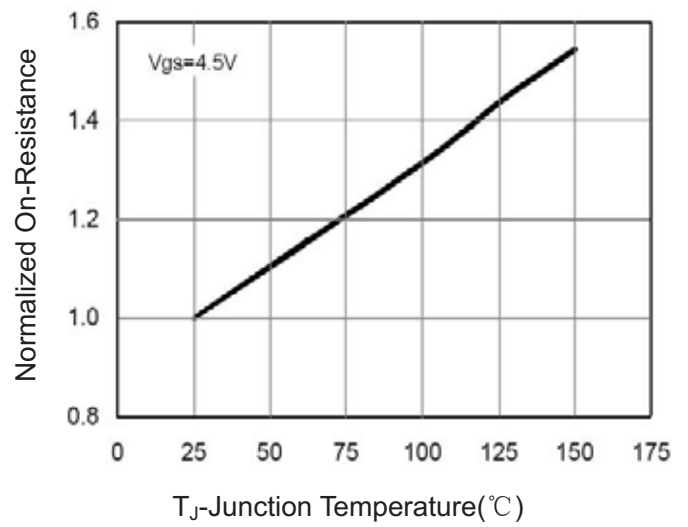

T_J -Junction Temperature($^\circ\text{C}$)
Figure 8 Drain-Source On-Resistance

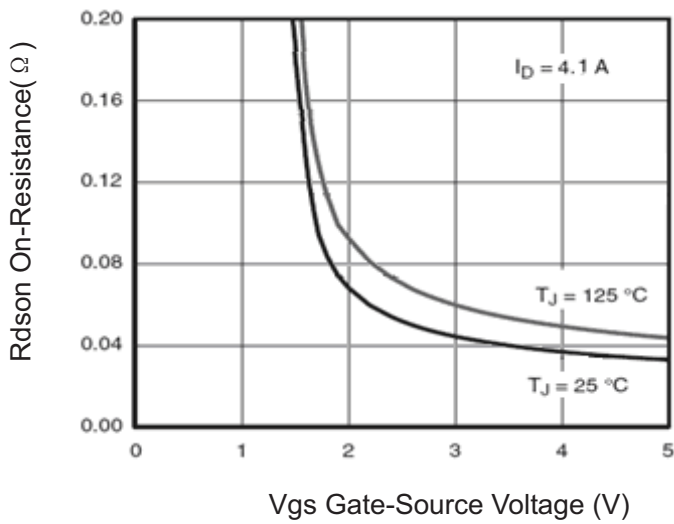

Vgs Gate-Source Voltage (V)
Figure 9 Rdson vs Vgs

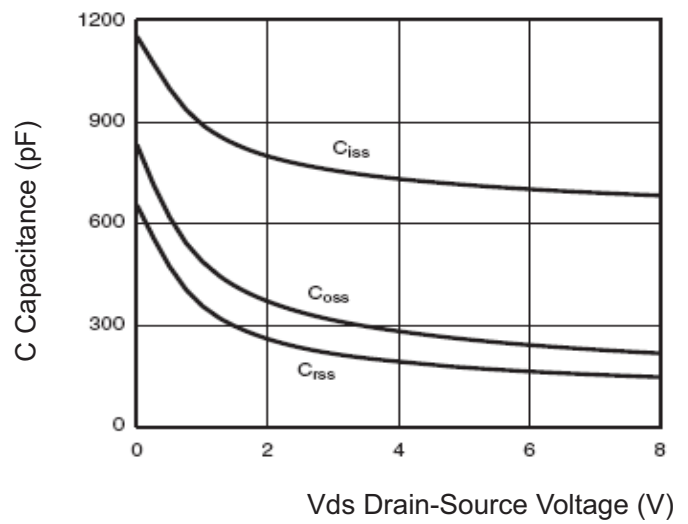

Vds Drain-Source Voltage (V)
Figure 10 Capacitance vs Vds

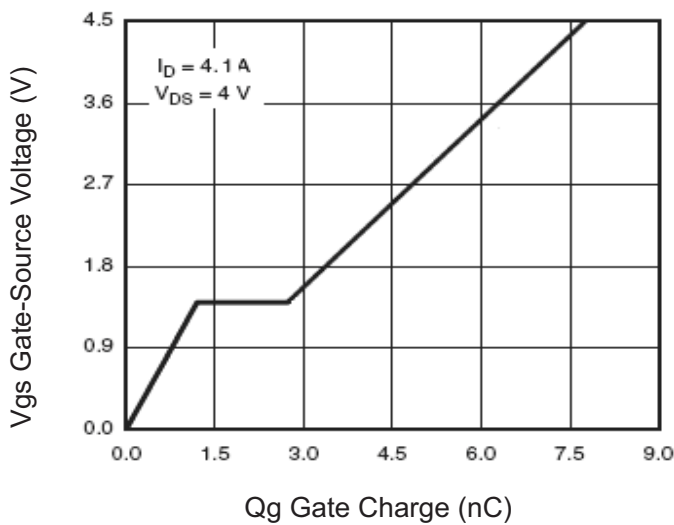

Qg Gate Charge (nC)
Figure 11 Gate Charge

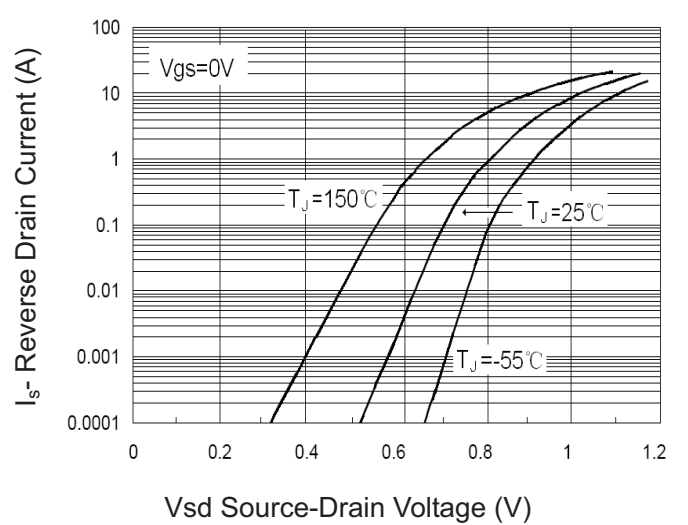

Vsd Source-Drain Voltage (V)
Figure 12 Source-Drain Diode Forward

RATING AND CHARACTERISTICS CURVES (RM4P20ES6)

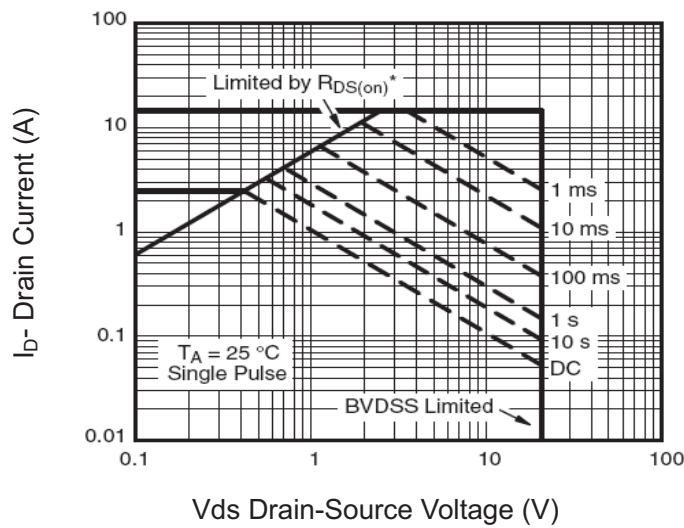

Figure 13 Safe Operation Area

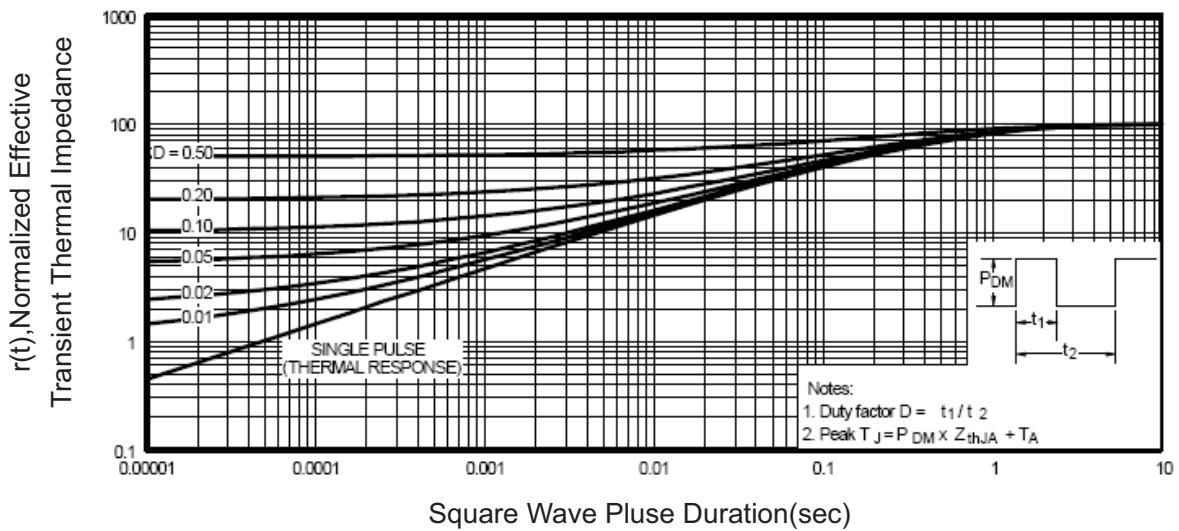
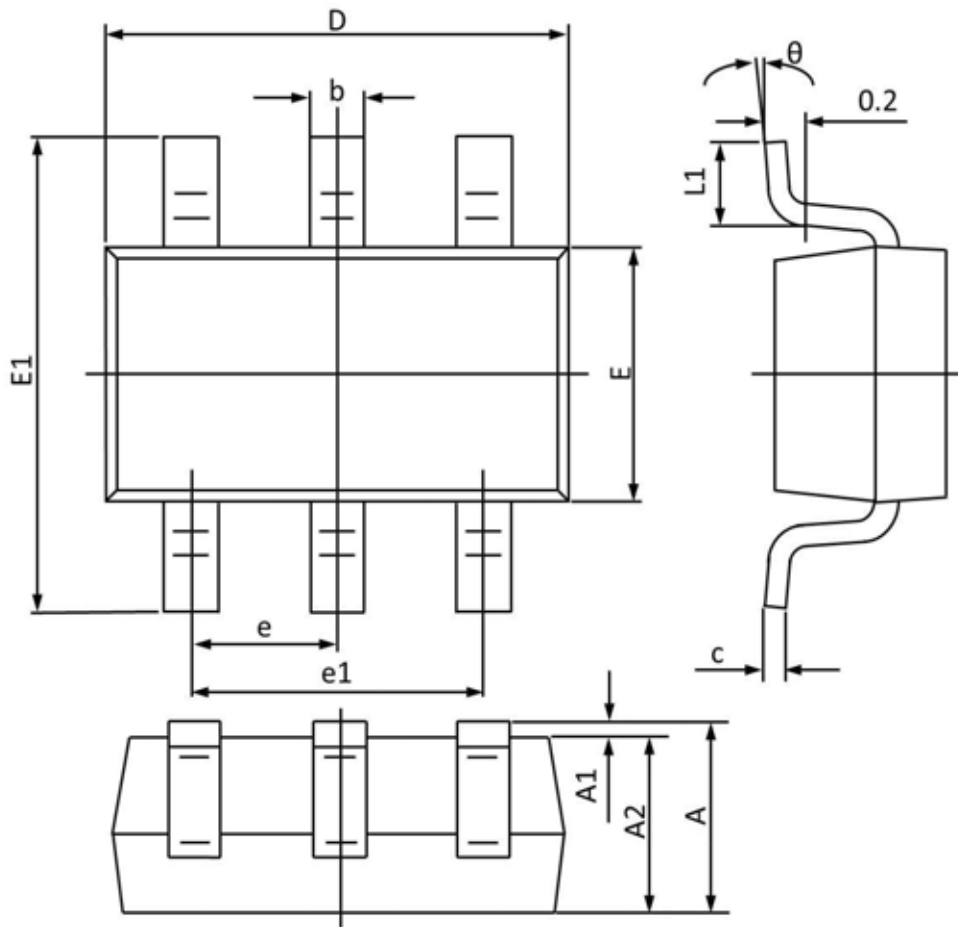

Figure 14 Normalized Maximum Transient Thermal Impedance

SOT23-6 PACKAGE INFORMATION



Symbol	Dimensions In Millimeters		Dimensions In Inches	
	MAX	MIN	MAX	MIN
A	1.450	-	0.057	-
A1	0.100	0.000	0.004	0.000
A2	1.300	1.050	0.051	0.041
b	0.500	0.300	0.020	0.012
c	0.200	0.100	0.008	0.004
D	3.100	2.700	0.122	0.106
E	1.800	1.400	0.071	0.055
E1	3.000	2.600	0.118	0.102
e	0.95BSC		0.037BSC	
e1	2.000	1.800	0.079	0.071
L1	0.600	0.300	0.024	0.012
θ	10°	0°	10°	0°

DISCLAIMER NOTICE

Rectron Inc reserves the right to make changes without notice to any product specification herein, to make corrections, modifications, enhancements or other changes. Rectron Inc or anyone on its behalf assumes no responsibility or liability for any errors or inaccuracies. Data sheet specifications and its information contained are intended to provide a product description only. "Typical" parameters which may be included on RECTRON data sheets and/ or specifications can and do vary in different applications and actual performance may vary over time. Rectron Inc does not assume any liability arising out of the application or use of any product or circuit.

Rectron products are not designed, intended or authorized for use in medical, life-saving implant or other applications intended for life-sustaining or other related applications where a failure or malfunction of component or circuitry may directly or indirectly cause injury or threaten a life without expressed written approval of Rectron Inc. Customers using or selling Rectron components for use in such applications do so at their own risk and shall agree to fully indemnify Rectron Inc and its subsidiaries harmless against all claims, damages and expenditures.