



MD7612 Series is a high voltage (up to 40V) low power low dropout voltage regulator (LDO) manufactured in CMOS processes. It can deliver up to 1A of current while consuming only 1.6uA of quiescent current. It consists of a reference voltage generator, an error amplifier, a current foldback circuit, and a phase compensation circuit plus a driver transistor.

■ Features











- Ultra-low Quiescent Current: 1.6uA
- Maximum Input Voltage: 40V
- Output Voltage Highly Accurate: $\pm 2\%$
- Maximum Output Current: 1A
- Dropout Voltage: 10mV@ $I_{OUT}=10mA$
- Temperature Stability: $\pm 45ppm/^{\circ}C$
- ON/OFF Logic = Enable High
- Protections Circuits: Current Limiter, Foldback, Over Temperature Protection
- Output Capacitor: Low ESR Ceramic Capacitor Compatible

■ Applications

- Active SCSI Terminators
- Portable/ Plan Top/ Notebook Computers
- High Efficiency Linear Regulators
- SMPS Post Regulators
- Mother B/D Clock Supplies
- Disk Drives
- Battery Chargers

■ Product Selections

Product Name	V _{OUT} (V)	Package	Ordering Name	Marking	Package Information
MD7612A33	3.3V	SOT-89-3L	MD7612A33PA1	7612A33	Tape and Reel, 1000pcs
MD7612A36	3.6V	SOT-89-3L	MD7612A36PA1	7612A36	
MD7612A40	4.0V	SOT-89-3L	MD7612A40PA1	7612A40	
MD7612A50	5.0V	SOT-89-3L	MD7612A50PA1	7612A50	
MD7612AC0	12.0V	SOT-89-3L	MD7612AC0PA1	7612AC0	
MD7612E33	3.3V	SOT-89-5L	MD7612E33PC1	7612E33	Tape and Reel, 1000pcs
MD7612E36	3.6V	SOT-89-5L	MD7612E36PC1	7612E36	
MD7612E40	4.0V	SOT-89-5L	MD7612E40PC1	7612E40	
MD7612E50	5.0V	SOT-89-5L	MD7612E50PC1	7612E50	
MD7612EC0	12.0V	SOT-89-5L	MD7612EC0PC1	7612EC0	
MD7612C33	3.3V	SOT-223-3L	MD7612C33YA2	7612C33	Tape and Reel, 2500pcs
MD7612C36	3.6V	SOT-223-3L	MD7612C36YA2	7612C36	
MD7612C40	4.0V	SOT-223-3L	MD7612C40YA2	7612C40	
MD7612C50	5.0V	SOT-223-3L	MD7612C50YA2	7612C50	
MD7612CC0	12.0V	SOT-223-3L	MD7612CC0YA2	7612CC0	

MD7612F33	3.3V	SOT-223-3L	MD7612F33YA2	 7612F33	Tape and Reel, 2500pcs
MD7612F36	3.6V	SOT-223-3L	MD7612F36YA2	 7612F36	
MD7612F40	4.0V	SOT-223-3L	MD7612F40YA2	 7612F40	
MD7612F50	5.0V	SOT-223-3L	MD7612F50YA2	 7612F50	
MD7612FC0	12.0V	SOT-223-3L	MD7612FC0YA2	 7612FC0	
MD7612D33	3.3V	TO-252-2L	MD7612D33UA2	 7612D33	Tape and Reel, 2500pcs
MD7612D36	3.6V	TO-252-2L	MD7612D36UA2	 7612D36	
MD7612D40	4.0V	TO-252-2L	MD7612D40UA2	 7612D40	
MD7612D50	5.0V	TO-252-2L	MD7612D50UA2	 7612D50	
MD7612DC0	12.0V	TO-252-2L	MD7612DC0UA2	 7612DC0	

Notes:

1* Customer can request to customize the output voltage ranged from 1.2V to 15V if desired voltage is not found in the selections.

2* Customer can request customization of package choice.

3* Please pay attention to the MARKING of the product package type.

Pin Configuration and Functions

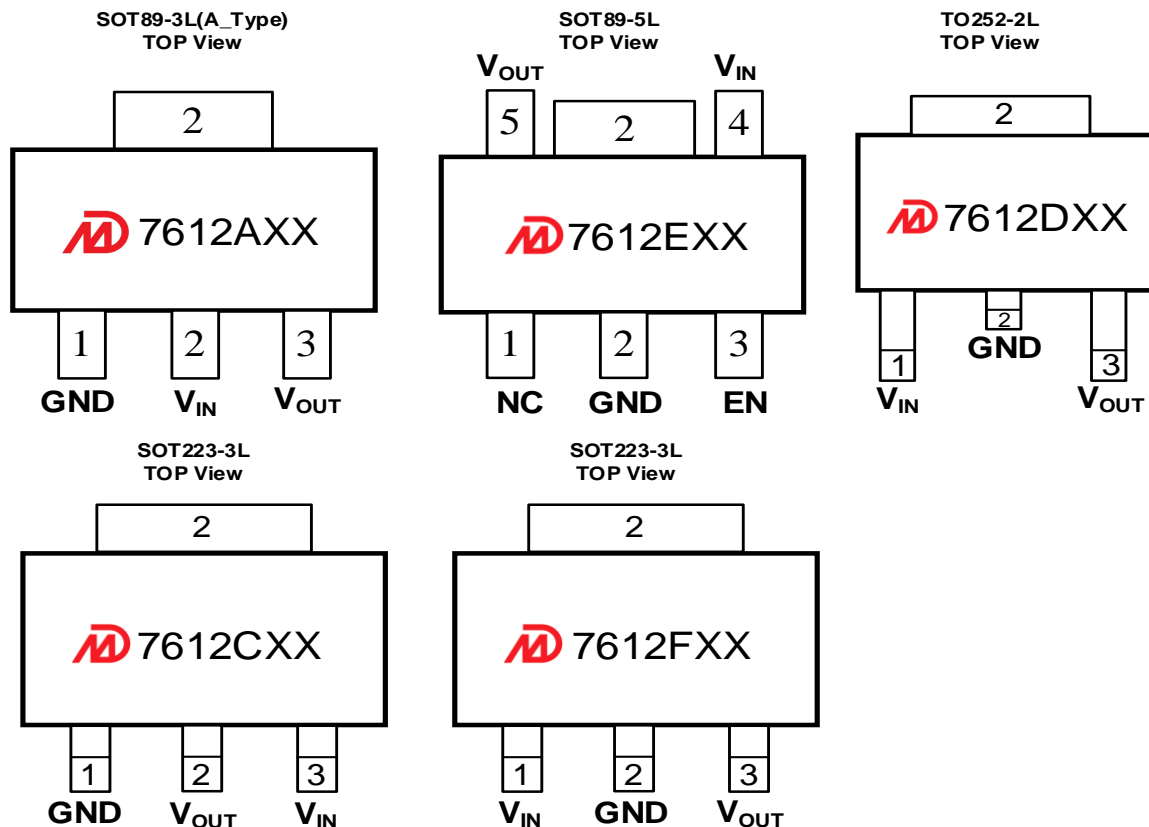

Pin Functions

Name	Description
V _{IN}	Power Input Pin.
EN	Enable pin. Drive this pin high to enable the device. Drive this pin low to put the device into low current shutdown.
V _{OUT}	Regulated output voltage pin
GND	Ground

■ Absolute Maximum Ratings (Unless otherwise indicated: $T_a=25^{\circ}\text{C}$)

Parameter	Symbol	Ratings	Units
Input Voltage	V_{IN}	-0.3 ~ 45	V
Output Voltage	V_{OUT}	$V_{SS}-0.3 \sim V_{IN}+0.3V$	
Power Dissipation	P_D	SOT-89-3L 1000 SOT-89-5L 1000 SOT-223-3L 1500 TO-252-2L 1800	mW
Thermal Resistance	$R_{\theta JB}^{(1)}$	SOT-89-3L 100 SOT-89-5L 100 SOT-223-3L 66 TO-252-2L 55	$^{\circ}\text{C}/\text{W}$
Operating Ambient Temperature	T_{opr}	-40 ~ +85	$^{\circ}\text{C}$
Storage Temperature	T_{stg}	-40 ~ +125	
ESD Protection	ESD HBM	6000	V
Humidity sensitive level	MSL	3	

Note: Stresses above those listed under "Absolute Maximum Ratings" may cause permanent damage to the device.

⁽¹⁾ Mounted on JEDEC standard 4layer (2s2p) PCB test board

■ Typical Applications

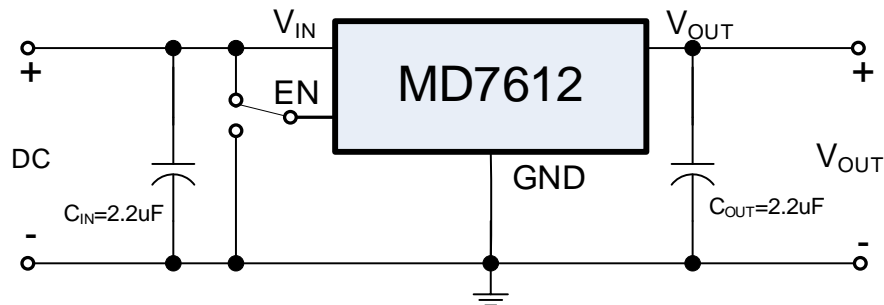

■ Notes on Use

Input Capacitor (C_{IN}): 2.2 μF above

Output Capacitor (C_{OUT}): 2.2 μF above

Normally, if the input voltage (V_{in}) increases, it is better to increase the output capacitance (C_{out})

■ Electrical Characteristics

MD7612 Series (Unless otherwise indicated: $T_a=25^{\circ}\text{C}$)

PARAMETER	SYMBOL	CONDITIONS	MIN.	TYP.	MAX.	UNIT	
Output Voltage*1	$V_{\text{OUT(S)}}$	$V_{\text{IN}}=V_{\text{OUT(S)}}+2\text{V}$, $I_{\text{OUT}}=10\text{mA}$	$V_{\text{OUT(S)}}\times 0.98$	$V_{\text{OUT(S)}}$	$V_{\text{OUT(S)}}\times 1.02$	V	
Dropout Voltage*2	V_{DROP}	$I_{\text{OUT}}=10\text{mA}$		10	20	mV	
		$I_{\text{OUT}}=1\text{A}$		1000	1800		
Line Regulation	$\frac{\Delta V_{\text{OUT}}}{\Delta V_{\text{IN}} \cdot V_{\text{OUT(S)}}}$	$V_{\text{OUT(S)}}+2\text{V}\leq V_{\text{IN}}\leq 40\text{V}$ $I_{\text{OUT}}=1\text{mA}$		0.01	0.02	%/V	
Load Regulation	ΔV_{OUT2}	$V_{\text{IN}}=V_{\text{OUT(S)}}+2\text{V}$ $1\text{mA}\leq I_{\text{OUT}}\leq 300\text{mA}$	$V_{\text{OUT(S)}}\leq 5.3\text{V}$		20	40	mV
			$V_{\text{OUT(S)}}>5.3\text{V}$		40	80	
Temperature Stability	$\frac{\Delta V_{\text{OUT}}}{\Delta T_a \cdot V_{\text{OUT(S)}}}$	$V_{\text{IN}}=V_{\text{OUT(S)}}+2\text{V}$, $I_{\text{OUT}}=10\text{mA}$ $-40^{\circ}\text{C}\leq T_a\leq 85^{\circ}\text{C}$		± 45		ppm/ $^{\circ}\text{C}$	
GND Current	I_{GND}	No load	$V_{\text{OUT(S)}}<3.0\text{V}$	0.8	1.2	2	uA
			$3.0\leq V_{\text{OUT(S)}}\leq 5.3$	0.8	1.6	2.5	
			$V_{\text{OUT(S)}}>5.3\text{V}$	1.5	2.5	3	
		$I_{\text{OUT}}=100\text{mA}$		480			
Shutdown Current*3	I_{SHUT}	$V_{\text{IN}}=40\text{V}$, $V_{\text{EN}}=0\text{V}$		0.1	1		
Input Voltage	V_{IN}	---	2.2		40	V	
Maximum Output Current	I_{OUTMAX}		1			A	
Current Limit*4	I_{LIM}	$V_{\text{IN}}=V_{\text{OUT(S)}}+2\text{V}$, $V_{\text{OUT}}=0.9 \times V_{\text{OUT(S)}}$		1.6			
Short Circuit Current*5	I_{SHORT}	$V_{\text{IN}}=V_{\text{EN}}=V_{\text{OUT(S)}}+2\text{V}$ $V_{\text{OUT}}=0\text{V}$		230		mA	
Power Supply Rejection Ratio	PSRR	$f=10\text{Hz}$, $V_{\text{OUT(S)}}=3.6\text{V}$		72		dB	
		$f=100\text{Hz}$, $V_{\text{OUT(S)}}=3.6\text{V}$		70			
		$f=1\text{kHz}$, $V_{\text{OUT(S)}}=3.6\text{V}$		65			
EN 'H' Level Voltage*3	V_{ENH}		1.6		40.0	V	
EN 'L' Level Voltage*3	V_{ENL}		0		0.5		
EN 'H' Level Current*3	I_{ENH}	$V_{\text{IN}}=40\text{V}$, $V_{\text{EN}}=V_{\text{IN}}$	-0.1		0.1	uA	
EN 'L' Level Voltage*3	I_{ENL}	$V_{\text{IN}}=40\text{V}$, $V_{\text{EN}}=0$	-0.1		0.1		
Over Temperature Protection	OTP	$I_{\text{OUT}}=10\text{mA}$		155		$^{\circ}\text{C}$	

Notes:

- $V_{\text{OUT(S)}}$: Output voltage when $V_{\text{IN}}=V_{\text{OUT}}+2\text{V}$, $I_{\text{OUT}}=1\text{mA}$.
- $V_{\text{DROP}}=V_{\text{IN1}} - (V_{\text{OUT(S)}}\times 0.98)$ where V_{IN1} is the input voltage when $V_{\text{OUT}} = V_{\text{OUT(S)}}\times 0.98$.
- Parameters with EN pin.
- I_{LIM} : Output current when $V_{\text{IN}}=V_{\text{OUT(S)}}+2\text{V}$ and $V_{\text{OUT}} = 0.95\times V_{\text{OUT(S)}}$.
- V_{OUT} pin should be shorted to GND pin, and the impedance between them is less than 0.1 ohm.

■ Typical Performance Characteristics (Continued)

Test Conditions: $V_{IN}=V_{OUT}+2.0V$, $C_{IN}=2.2\mu F$, $C_{OUT}=2.2\mu F$, unless otherwise indicated.

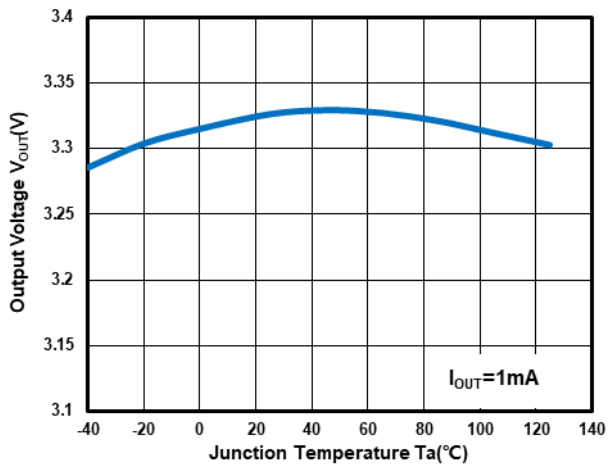

Output Voltage vs Temperature at $V_{OUT}=3.3V$

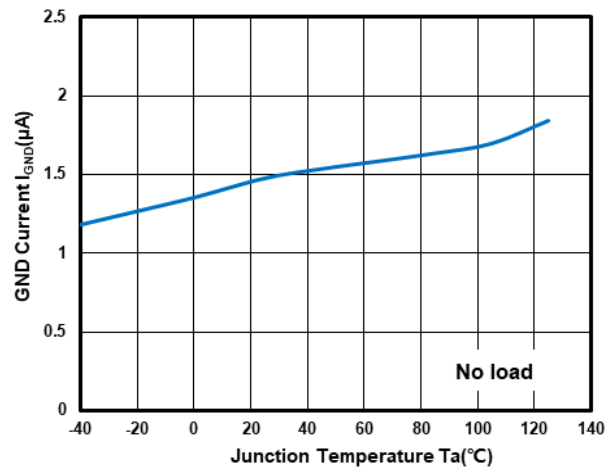

GND Current vs Temperature at $V_{OUT}=3.3V$

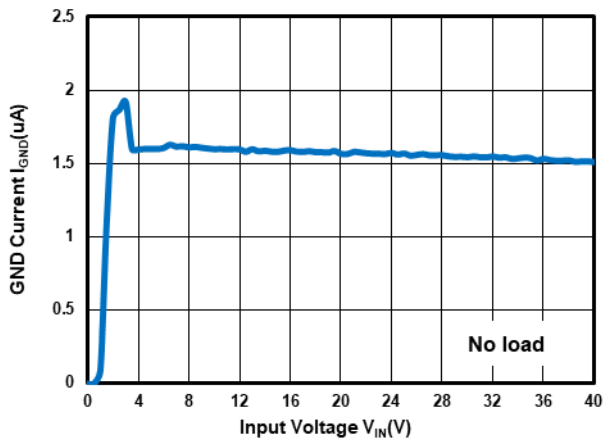

GND Current vs Input Voltage at $V_{OUT}=3.3V$

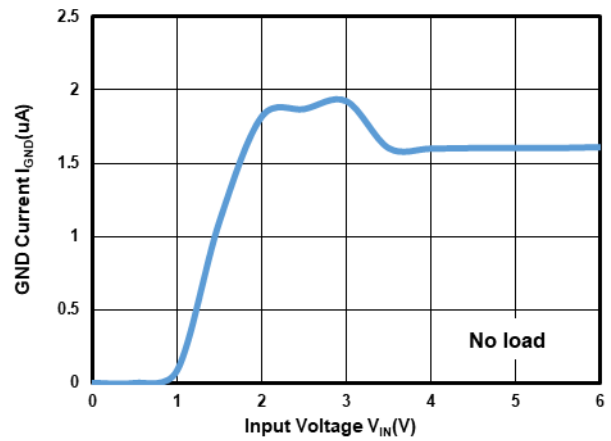

GND Current vs Input Voltage at $V_{OUT}=3.3V$

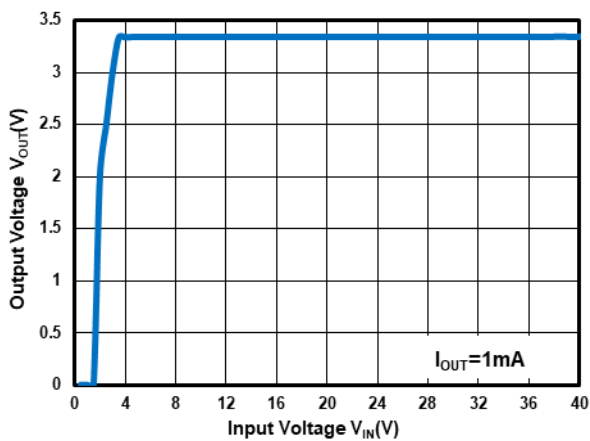

Output Voltage vs Input Voltage at $V_{OUT}=3.3V$

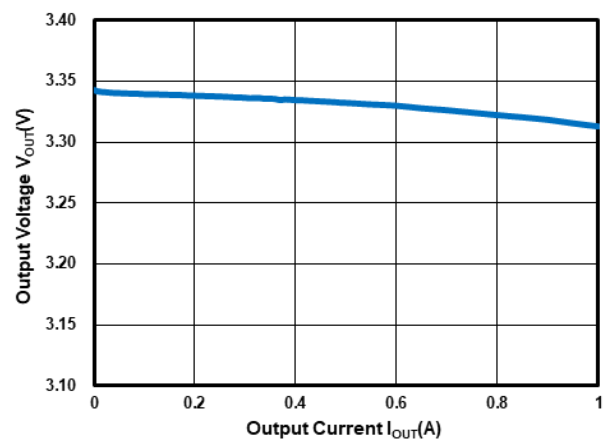

Output Voltage vs Output Current at $V_{OUT}=3.3V$

■ Typical Performance Characteristics (Continued)

Test Conditions: $V_{IN}=V_{OUT}+2.0V$, $C_{IN}=2.2\mu F$, $C_{OUT}=2.2\mu F$, unless otherwise indicated.

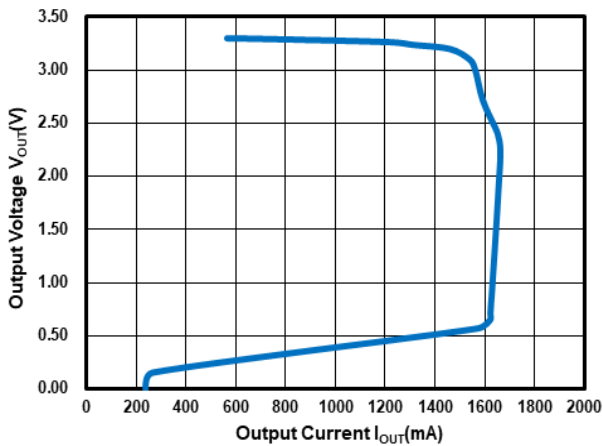

Output Current Fold-back at $V_{OUT}=3.3V$

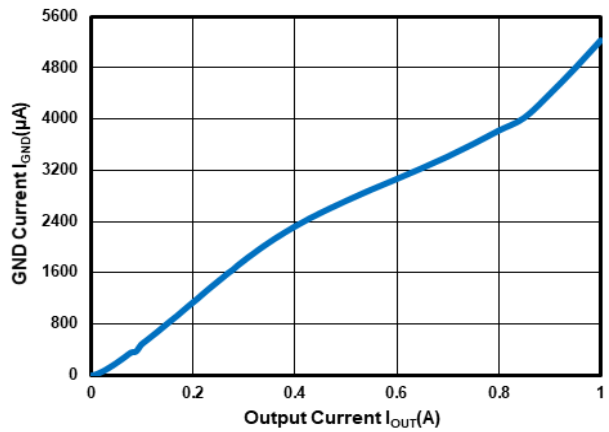

GND Current vs Output Current at $V_{OUT}=3.3V$

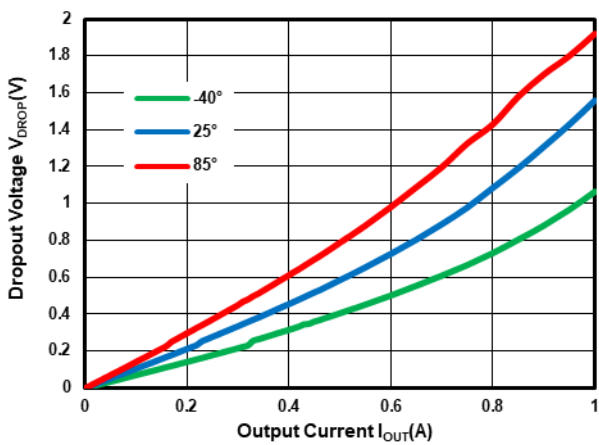

Dropout Voltage vs Temperature at $V_{OUT}=3.3V$

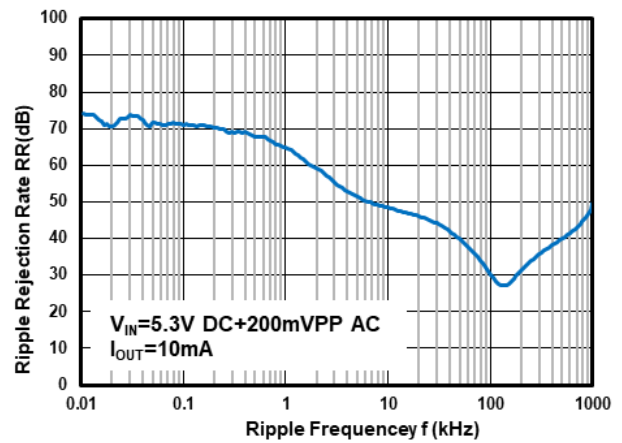

Power Supply Rejection Ratio at $V_{OUT}=3.3V$

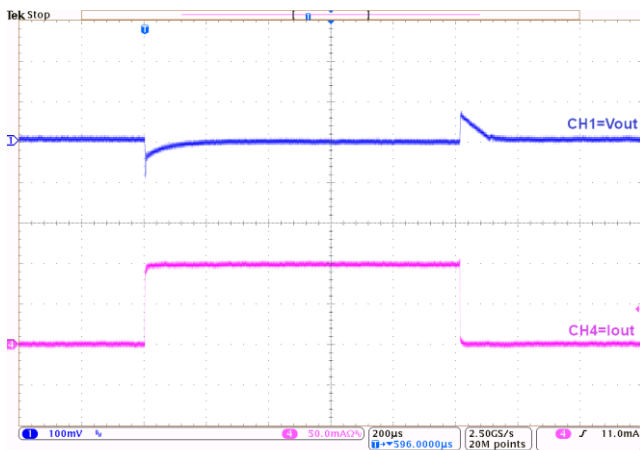

Load Transient at $V_{OUT}=3.3V$
($I_{OUT}=1mA\sim 100mA\sim 1mA$)

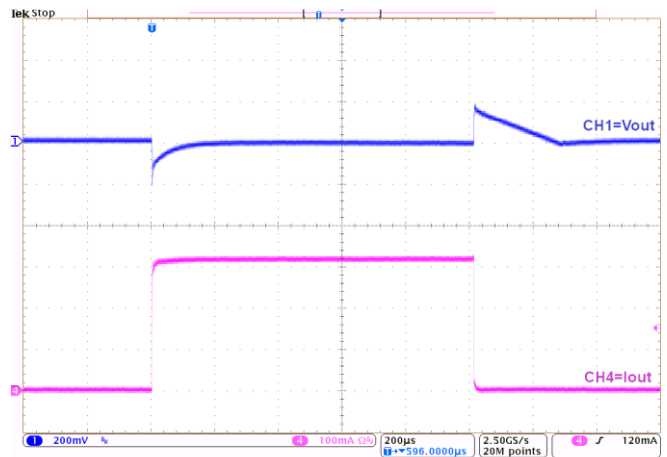

Load Transient at $V_{OUT}=3.3V$
($I_{OUT}=1mA\sim 300mA\sim 1mA$)

■ Typical Performance Characteristics (Continued)

Test Conditions: $V_{IN}=V_{OUT}+2.0V$, $C_{IN}=2.2\mu F$, $C_{OUT}=2.2\mu F$, unless otherwise indicated.

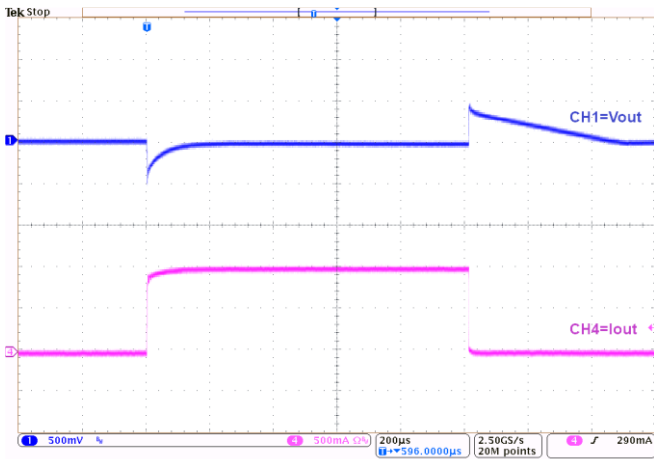

Load Transient at $V_{OUT}=3.3V$
($I_{OUT}=1mA\sim 1A\sim 1mA$)

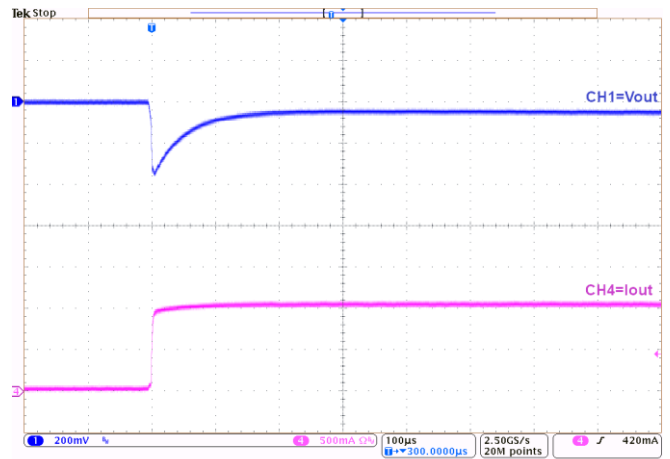

Load Transient at $V_{OUT}=3.3V$
($I_{OUT}=0mA\sim 1A$)

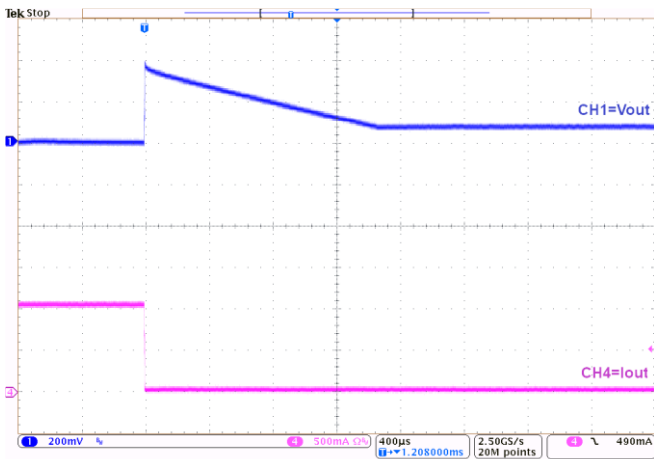

Load Transient at $V_{OUT}=3.3V$
($I_{OUT}=1A\sim 0mA$)

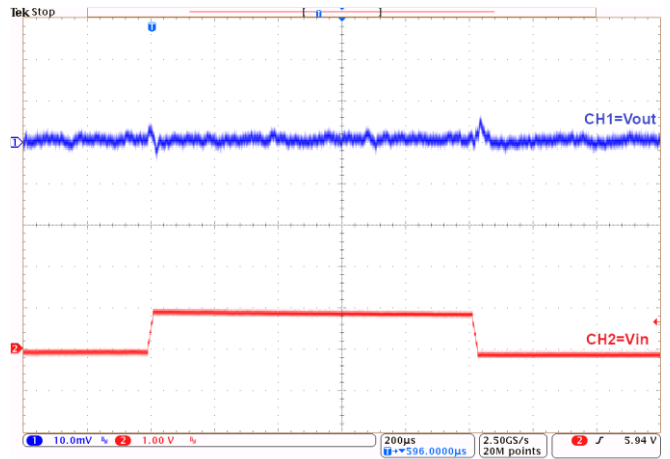

Line Transient at $V_{OUT}=3.3V$
($I_{OUT}=1mA$)

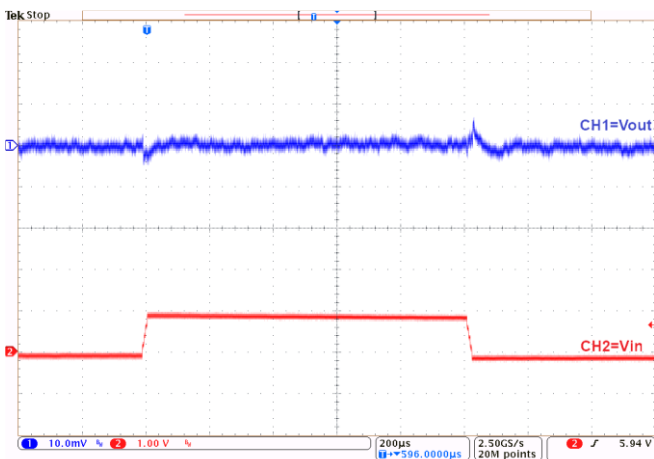

Line Transient at $V_{OUT}=3.3V$
($I_{OUT}=10mA$)

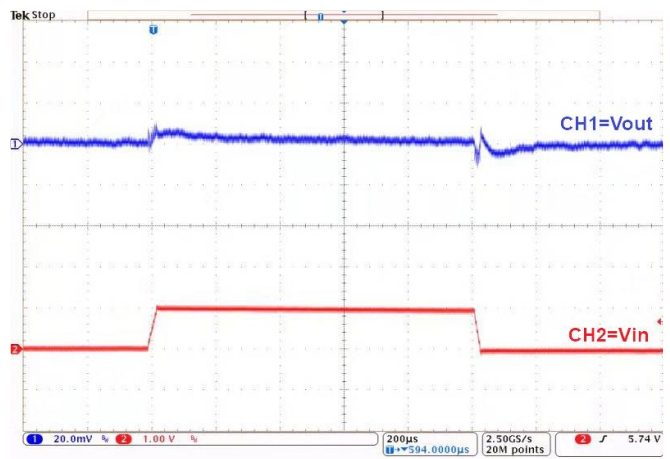

Line Transient at $V_{OUT}=3.3V$
($I_{OUT}=300mA$)

■ Typical Performance Characteristics (Continued)

Test Conditions: $V_{IN}=V_{OUT}+2.0V$, $C_{IN}=2.2\mu F$, $C_{OUT}=2.2\mu F$, unless otherwise indicated.

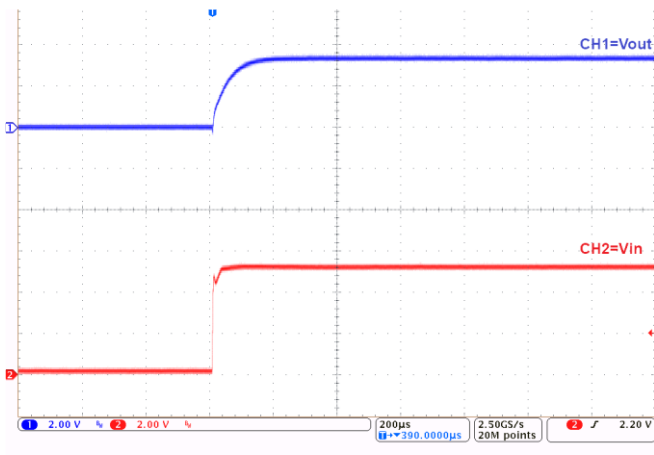

Power-Up at $V_{OUT}=3.3V$
($I_{OUT}=1mA$)

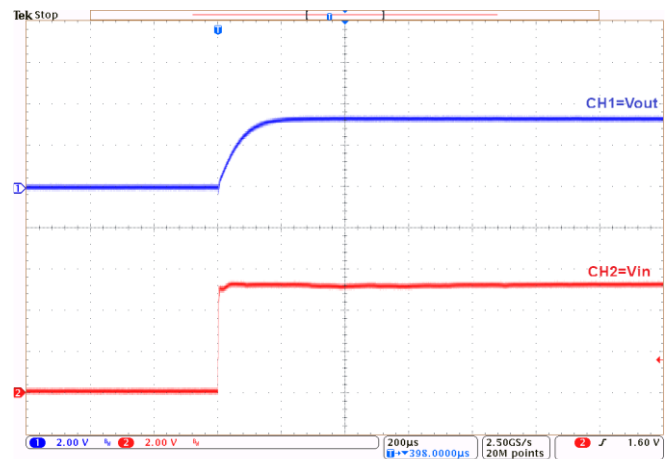

Power-Up at $V_{OUT}=3.3V$
($I_{OUT}=1A$)

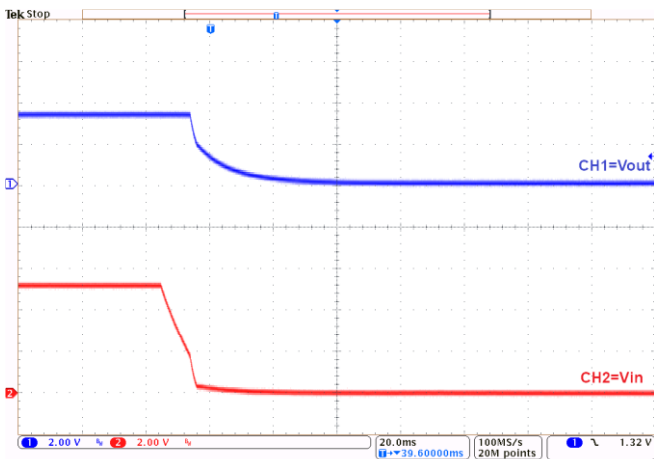

Power-Down at $V_{OUT}=3.3V$
($I_{OUT}=1mA$)

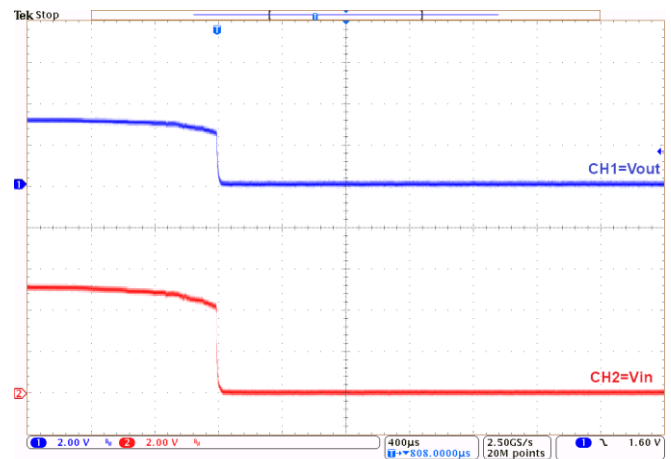

Power-Down at $V_{OUT}=3.3V$
($I_{OUT}=1A$)

■ Operational Explanation

1. Output voltage control

The voltage divided by resistors R1 and R2 is compared with the internal reference voltage by the error amplifier. The amplifier output then drives the P-channel MOSFET connected to the V_{OUT} pin. The output voltage at the V_{OUT} pin is regulated by this negative feedback system. The current limit circuit and short protect circuit operate in relation to output current level. Further, the IC's internal circuitry can be in operation or shutdown modes controlled by the CE pin's signal.

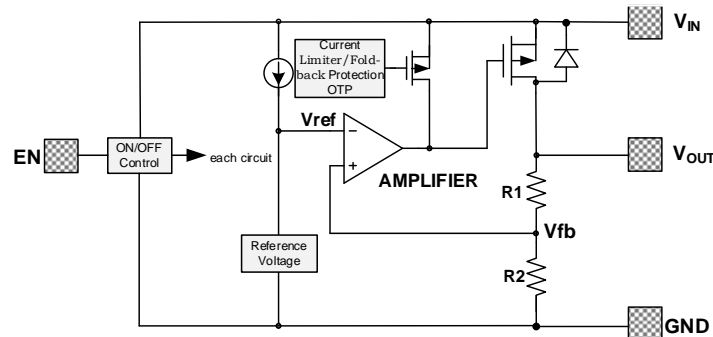

2. Pass transistor

The pass transistor with low turn-on resistance used in MD7612 is a P-channel MOSFET. If the potential on V_{OUT} pin is higher than V_{IN} , it is possible that IC will be destroyed due to reverse current which is caused by parasitic diodes between V_{IN} and V_{OUT} . Therefore, the V_{OUT} pin potential exceeds $V_{IN}+0.3V$ is not allowed.

3. Current foldback and over temperature protection

The MD7612 series includes a combination of a fixed current limiter circuit and a foldback circuit, which aid the operations of the current limiter and circuit protection. When the load current reaches the current limit level, the fixed current limiter circuit operates and output voltage drops. As a result of this drop in output voltage, the foldback circuit operates, output voltage drops further and output current decreases. This design can prevent the chip be damaged due to over temperature, moreover, the heat dissipation is limited by the package type.

Special attention should be paid to that the product of the dropout voltage on the chip and the output current must be smaller than the heat dissipation. If power consumption on the chip is more than the heat dissipation, OTP will protect the chip from damaging due to over temperature.

■ Notes:

1. The input and output capacitors should be placed as close as possible to the IC.
2. If the impedance of the power supply is high, which is caused by forgetting installing input capacitor or installing too small value capacitor, the oscillation may occur.
3. Pay attention to the operation conditions of input and output voltage and load current, such that the power consumption in the IC should not exceed the allowable power consumption of the package even though the chip has short circuit protection.
4. IC has a built-in anti-static protection (ESD) circuit, but please do not add excessive stress to the IC.

■ Packaging Information

TO-252-2L PACKAGE OUTLINE DIMENSIONS

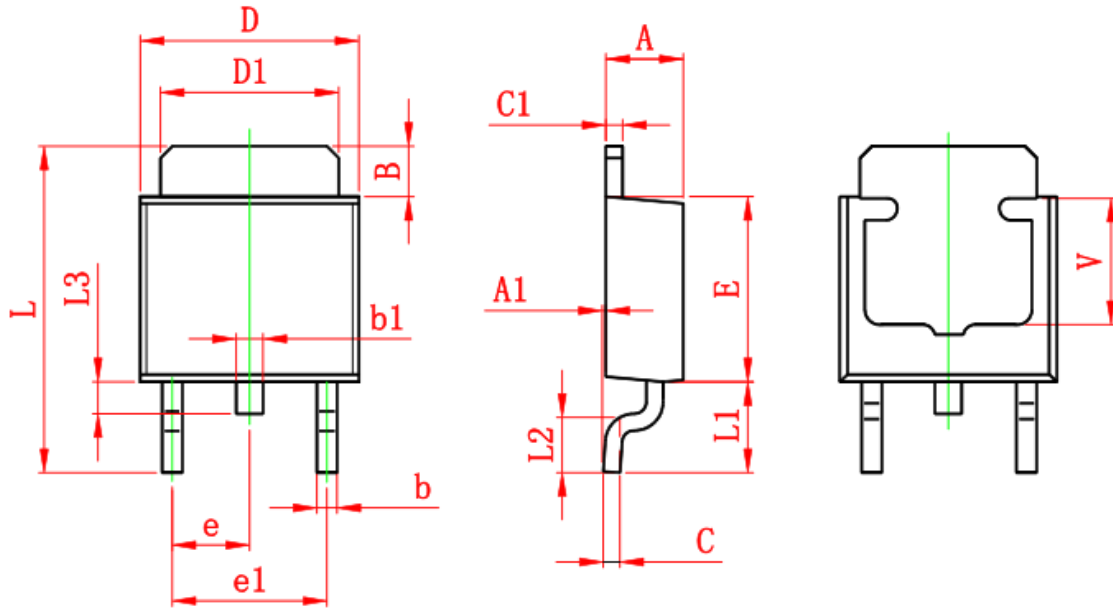

Symbol	Dimensions In Millimeters		Dimensions In Inches	
	Min.	Max.	Min.	Max.
A	2.200	2.400	0.087	0.094
A1	0.000	0.127	0.000	0.005
B	1.350	1.650	0.053	0.065
b	0.500	0.700	0.020	0.028
b1	0.700	0.900	0.028	0.035
c	0.430	0.580	0.017	0.023
c1	0.430	0.580	0.017	0.023
D	6.350	6.650	0.250	0.262
D1	5.200	5.400	0.205	0.213
E	5.400	5.700	0.213	0.224
e	2.300 TYP.		0.091 TYP.	
e1	4.500	4.700	0.177	0.185
L	9.500	9.900	0.374	0.390
L1	2.550	2.900	0.100	0.114
L2	1.400	1.780	0.055	0.070
L3	0.600	0.900	0.024	0.035
V	3.800 REF.		0.150 REF.	

■ Packaging Information (Continued)

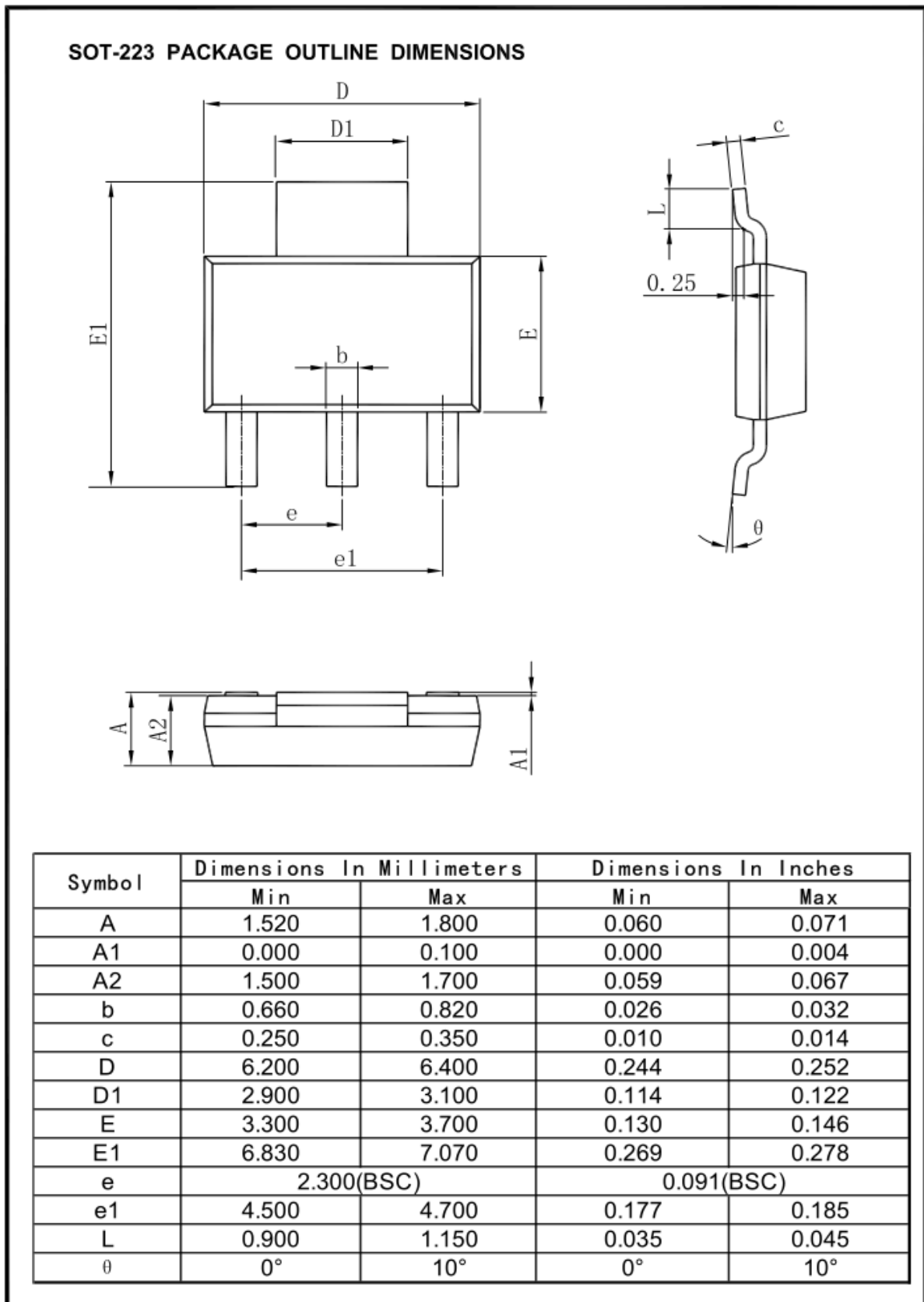

■ Packaging Information (Continued)

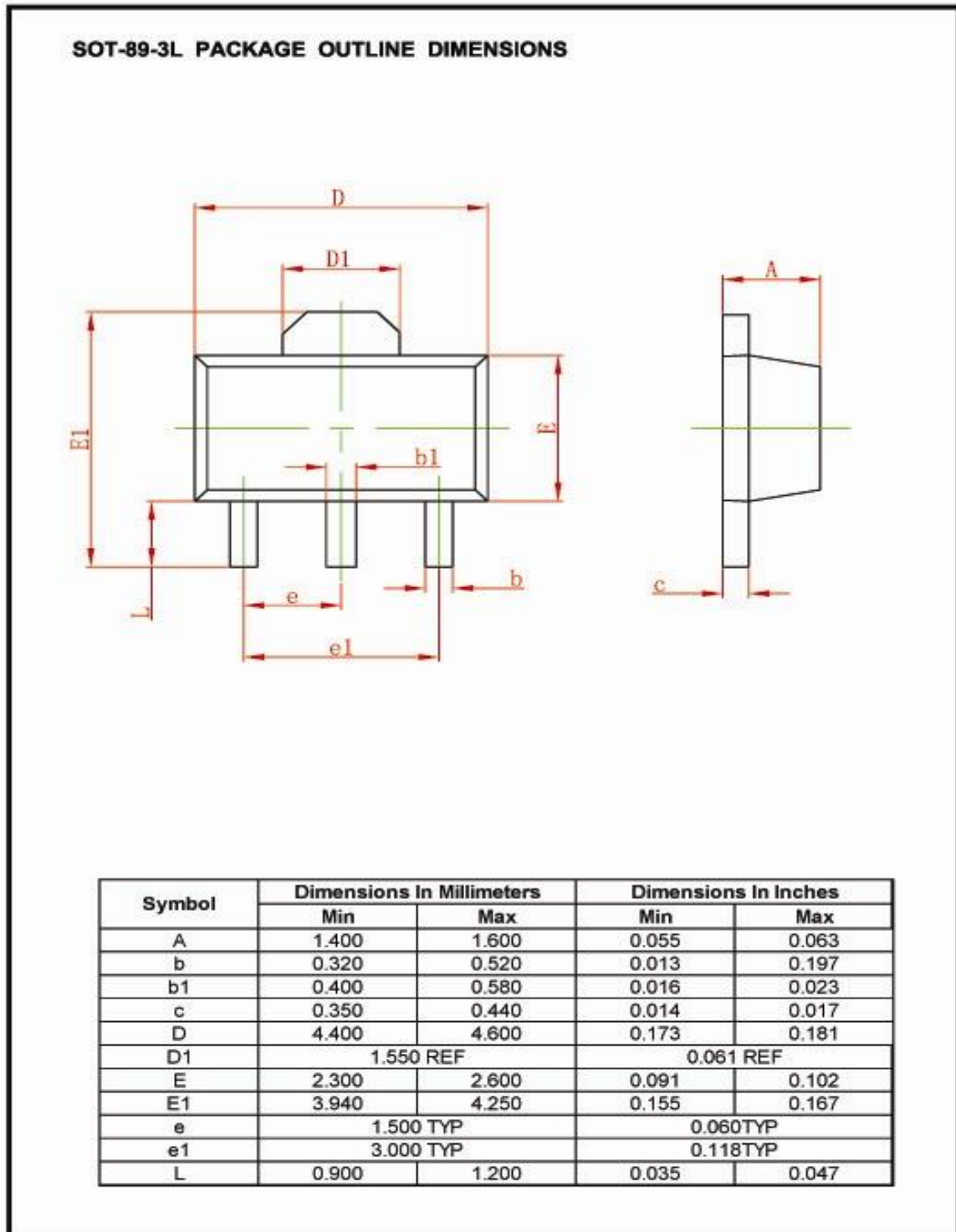

■ Packaging Information (Continued)

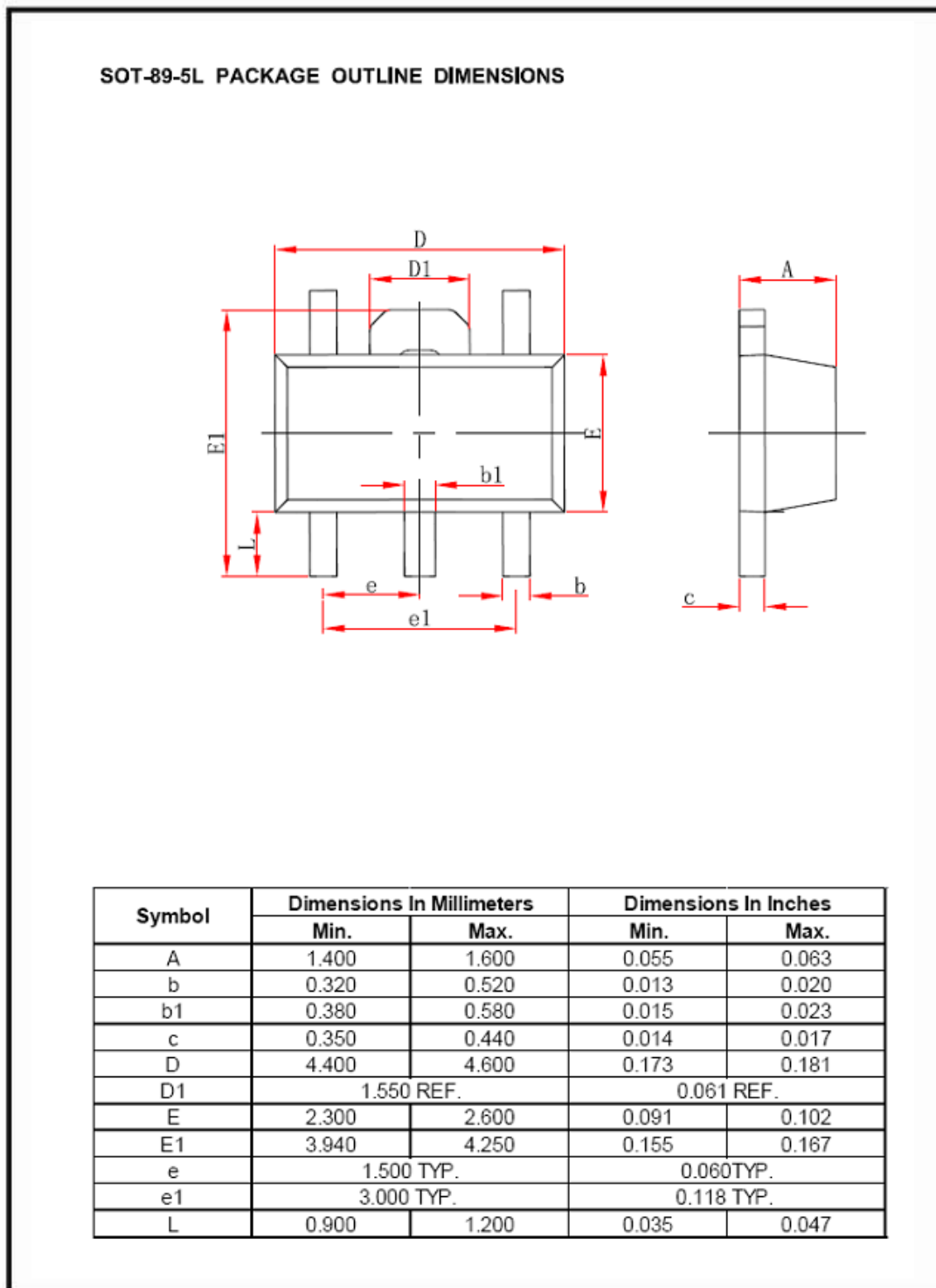

For the newest datasheet, please see the website:

www.md-ic.com.cn

Version V1.1: 20210930