

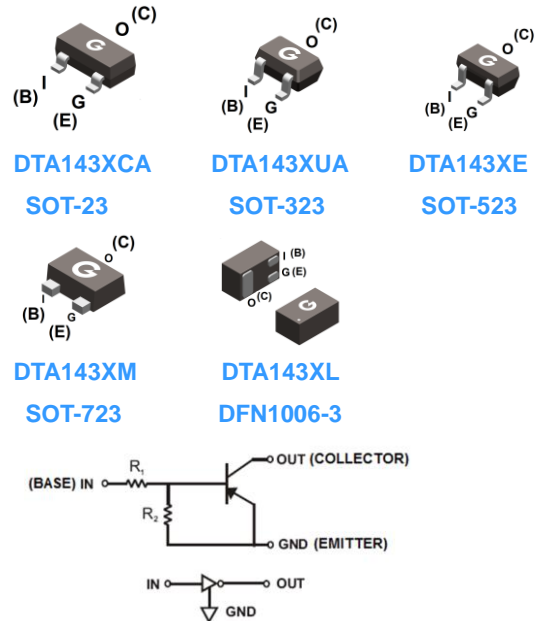
### Features

- Epitaxial planar die construction
- Built-in biasing resistors ( $R_1$ : 4.7k $\Omega$ ,  $R_2$ : 10k $\Omega$ )
- Also available in lead free version
- RoHS compliant with Halogen-free

HF

### Mechanical Data

- Case: SOT-23, SOT-323, SOT-523, SOT-723, DFN1006-3
- Molding Compound: UL Flammability Classification Rating 94V-0
- Terminals: Matte tin-plated leads; solderability-per MIL-STD-202, Method 208



### Ordering Information

Part Number	Package	Shipping Quantity	Marking Code
DTA143XCA	SOT-23	3000 pcs / Tape & Reel	33
DTA143XUA	SOT-323	3000 pcs / Tape & Reel	33
DTA143XE	SOT-523	3000 pcs / Tape & Reel	33
DTA143XM	SOT-723	10000 pcs / Tape & Reel	33
DTA143XL	DFN1006-3	10000 pcs / Tape & Reel	33

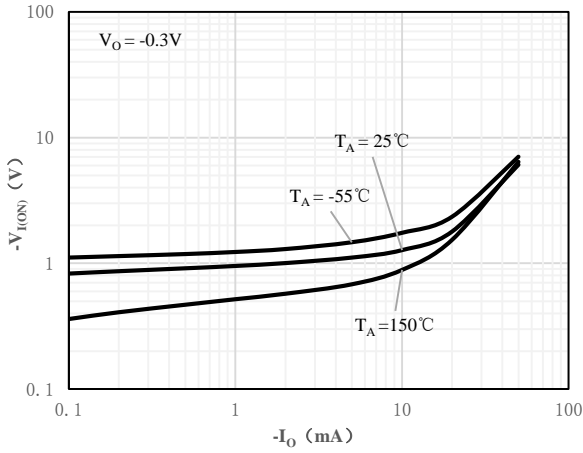
### Maximum Ratings (@ $T_A = 25^\circ\text{C}$ unless otherwise specified)

Parameter	Symbol	Value					Unit
		SOT-23	SOT-323	SOT-523	SOT-723	DFN1006-3	
Supply Voltage	$V_{CC}$	-50					V
Input Voltage	$V_I$	-20 to +7					V
Output Current	$I_O$	-100					mA
Collector Current	$I_{C(\text{Max})}$	-100					mA
Power Dissipation	$P_D$	200	200	150	100	100	mW
Junction Temperature Range	$T_J$	-55 ~ +150					$^\circ\text{C}$
Storage Temperature Range	$T_{STG}$	-55 ~ +150					$^\circ\text{C}$

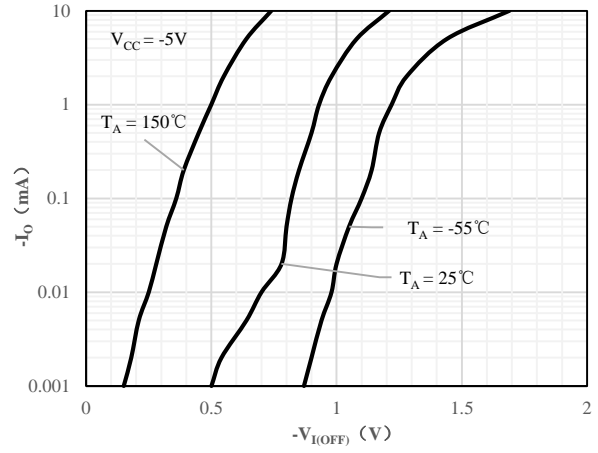
### Electrical Characteristics (@ $T_A = 25^\circ\text{C}$ unless otherwise specified)

Parameter	Symbol	Test Condition	Min.	Typ.	Max.	Unit
Input Voltage	$V_{I(OFF)}$	$V_{CC} = -5\text{V}, I_o = -100\mu\text{A}$	-0.3	-	-	V
Input Voltage	$V_{I(ON)}$	$V_o = -0.3\text{V}, I_o = -20\text{mA}$	-	-	-2.5	V
Output Voltage	$V_{O(on)}$	$I_o = -10\text{mA}, I_i = -0.5\text{mA}$	-	-	-0.3	V
Input Current	$I_i$	$V_i = -5\text{V}$	-	-	-1.8	mA
Output Current	$I_{O(off)}$	$V_{CC} = -50\text{V}, V_i = 0\text{V}$	-	-	-0.5	$\mu\text{A}$
DC Current Gain	$G_I$	$V_o = -5\text{V}, I_o = -10\text{mA}$	30	-	-	-
Input Resistor	$R_1$		3.29	4.7	6.11	k $\Omega$
Resistance ratio	$R_2/R_1$		1.7	2.1	2.6	-
Gain-Bandwidth Product	$f_T$	$V_{CE} = -10\text{V}, I_E = -5\text{mA}$ $f = 100\text{MHz}$	-	250	-	MHz

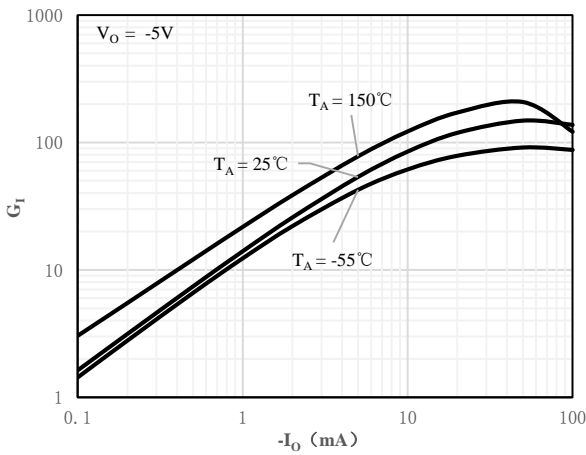
**Ratings and Characteristics Curves** (@  $T_A = 25^\circ\text{C}$  unless otherwise specified)



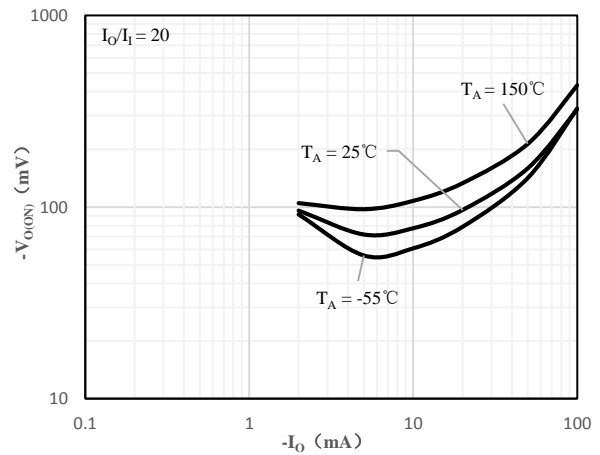
**Fig 1 Input Voltage vs Output Current**



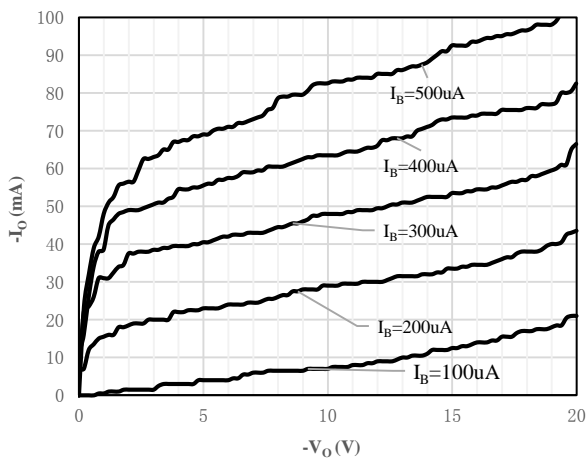
**Fig 2 Output Current vs Input Voltage**



**Fig 3 DC Current Gain vs Output Current**

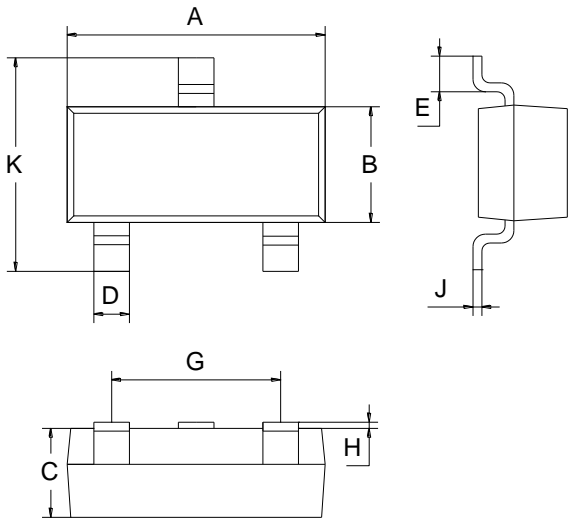


**Fig 4 Output Voltage vs Output Current**

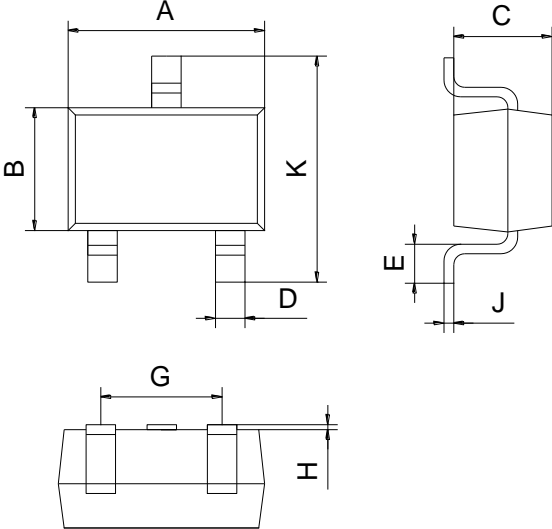


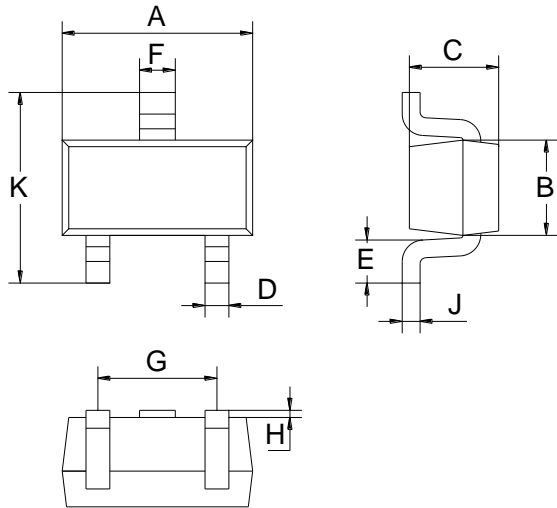
**Fig 5 Output Current vs. Output Voltage**

### Package Outline Dimensions (Unit: mm)

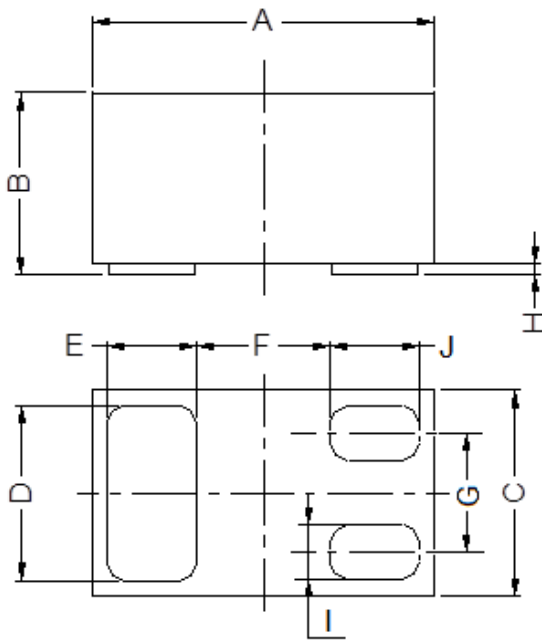
SOT-23			
Dimension	Min.	Max.	
A	2.70	3.10	
B	1.10	1.50	
C	0.90	1.10	
D	0.30	0.50	
E	0.35	0.48	
G	1.80	2.00	
H	0.02	0.10	
J	0.05	0.15	
K	2.20	2.60	

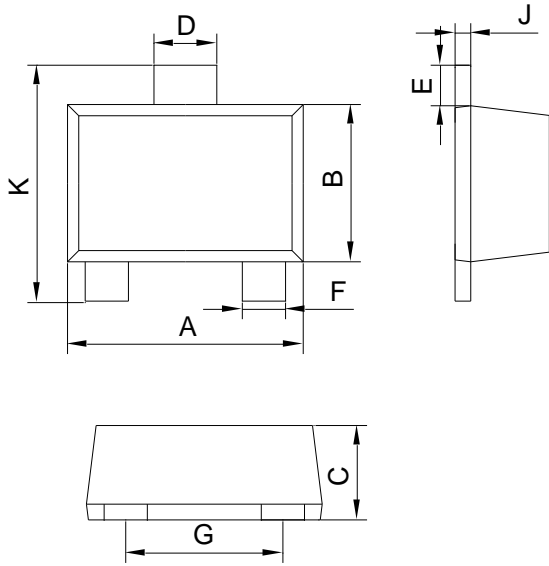
SOT-323			
Dimension	Min.	Max.	
A	2.00	2.20	
B	1.15	1.35	
C	0.90	1.10	
D	0.15	0.35	
E	0.25	0.40	
G	1.20	1.40	
H	0.02	0.10	
J	0.05	0.15	
K	2.20	2.40	



SOT-523		
Dimension	Min.	Max.
A	1.50	1.70
B	0.75	0.85
C	0.60	0.80
D	0.15	0.30
E	0.30	0.40
F	0.25	0.40
G	0.90	1.10
H	0.02	0.10
J	0.08	0.18
K	1.45	1.75



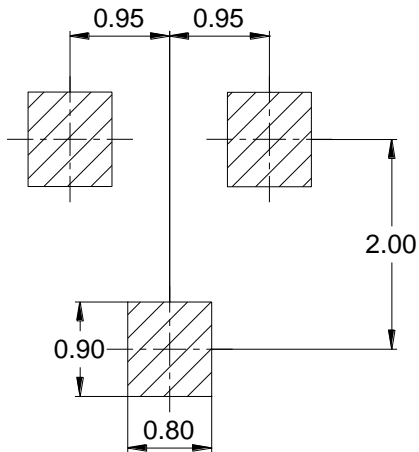
DFN1006-3			
Dimension	Min.	Typ.	Max.
A	0.95	1.00	1.075
B	0.47	0.50	0.53
C	0.55	0.60	0.675
D	0.45	0.50	0.55
E/J	0.20	0.25	0.30
F	-	0.40	-
G	-	0.35	-
H	0	0.03	0.05
I	0.10	0.15	0.20



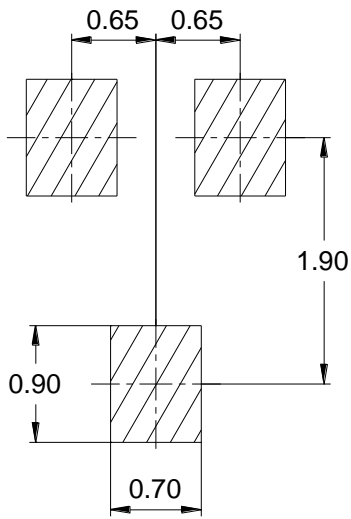
SOT-723		
Dimension	Min.	Max.
A	1.10	1.30
B	0.70	0.90
C	0.40	0.54
D	0.22	0.42
E	0.10	0.30
F	0.12	0.32
G	0.70	0.90
J	0.08	0.15
K	1.10	1.30

**Mounting Pad Layout** (Unit: mm)

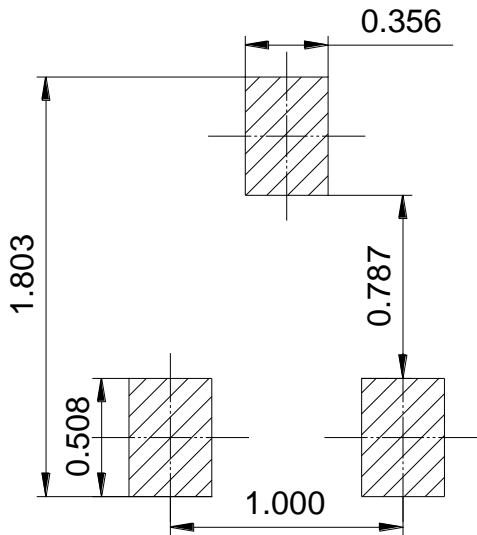
**SOT-23**



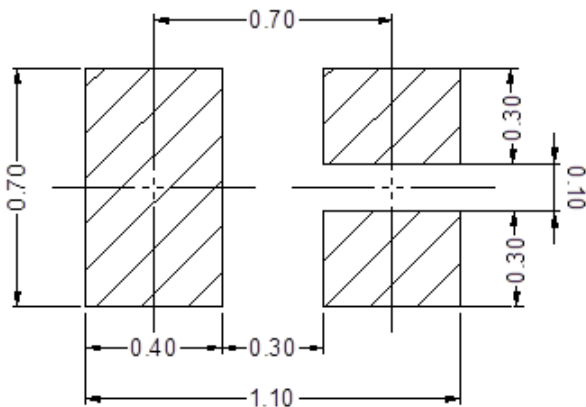
SOT-323



SOT-523



DFN1006-3



SOT-723

