

SURFACE MOUNT SCHOTTKY BARRIER DIODE

BAT42W/BAT43W

■ Features

- Low Forward Voltage Drop
- Fast Switching Time
- Surface Mount Package Ideally Suited for Automatic Insertion

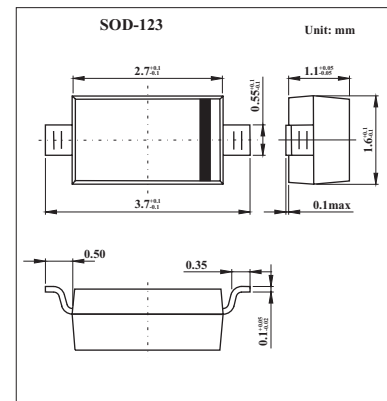

■ Absolute Maximum Ratings $T_a = 25^\circ\text{C}$

Parameter	Symbol	Value	Unit
Peak Repetitive Reverse Voltage	V_{RRM}	30	V
Working Peak Reverse Voltage	V_{RWM}	30	V
DC Blocking Voltage	V_R	30	V
RMS Reverse Voltage	$V_{R(RMS)}$	21	V
Forward Continuous Current (Note 1)	I_{FM}	500	mA
Repetitive Peak Forward Current (Note 1) @ $t < 1.0\text{s}$	I_{FRM}	200	mA
Non-Repetitive Peak Forward Surge Current @ $t < 10\text{ms}$	I_{FSM}	4	A
Power Dissipation	P_d	200	mW
Thermal Resistance Junction to Ambient Air (Note 1)	$R_{\theta JA}$	500	$^\circ\text{C}/\text{W}$
Operating and Storage Temperature Range	T_j, T_{STG}	-55 to + 150	$^\circ\text{C}$

Note 1

1. Part mounted on FR-4 board with recommended pad layout

SURFACE MOUNT SCHOTTKY BARRIER DIODE

BAT42W/BAT43W

■ Electrical Characteristics $T_a = 25^\circ\text{C}$

Parameter	Symbol	Conditions	Min	Max	Unit
Reverse Breakdown Voltage (Note 2)	V_R	$I_R = 100 \mu\text{A}$	30		V
Forward Voltage Drop (Note 2) BAT42W	V_{RM}	$I_F = 10 \text{mA}$		0.4	V
		$I_F = 50 \text{mA}$		0.65	
Forward Voltage Drop (Note 2) BAT43W	V_{RM}	$I_F = 2.0 \text{mA}$	0.26	0.33	V
		$I_F = 15 \text{mA}$		0.45	
Peak Reverse Current (Note 2)	I_{RM}	$V_R = 25\text{V}$		500	nA
		$V_R = 25 \text{V}, T_j = 100^\circ\text{C}$		100	μA
Total Capacitance	C_T	$V_R = 1.0 \text{V}, f = 1.0\text{MHz}$		10	pF
Reverse Recovery Time	t_{rr}	$I_F = I_R = 10 \text{mA},$ $I_{rr} = 0.1 \times I_R, R_L = 100 \Omega$		5.0	ns
Rectification Efficiency	η_V	$R_L = 15 \Omega, C_L = 300\text{pF},$ $f = 45\text{MHz}, V_{RF} = 2.0\text{V}$	80		%

Note

2. Short duration pulse test used to minimize self-heating effect.

■ Marking

Type	BAT42W	BAT43W
Marking	S7	S8