

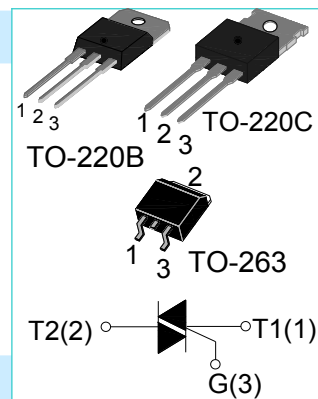

Standard TRIACS
BTB12 Serial
Main Features:

$I_{T(RMS)}$	V_{DRM}/V_{RRM}	V_{TM}
12 A	600V 800V	≤ 1.55 V

Description:

High current density due to double mesa technology; Glass Passivation. BTB12 series TRIACS is suitable for general purpose AC switching. They can be used as an ON/OFF Function in applications such as static relays, heating regulation, induction motor starting circuits, or for phase control operation light dimmers, motor speed controllers.

Absolute Ratings (limiting values) :

Symbol	Parameter	Value	Unit	
T_{stg}	Storage junction temperature range	- 40 to + 150	$^{\circ}C$	
T_j	Operating junction temperature range	- 40 to + 125	$^{\circ}C$	
$I_{T(RMS)}$	RMS on-state current	TO-220BC(Non-Ins) (TC=105 $^{\circ}C$)	12	A
		TO-263 (TC=115 $^{\circ}C$)		
I_{TSM}	Non repetitive surge peak on-state current (tp=10ms)	120	A	
V_{DRM}	Repetitive peak off-state voltage(Tj =25 $^{\circ}C$)	600/800	V	
V_{RRM}	Repetitive peak reverse voltage(Tj =25 $^{\circ}C$)	600/800	V	
V_{DSM}	Non repetitive surge peak Off-state voltage	$V_{DRM} + 100$	V	
V_{RSM}	Non repetitive peak reverse voltage	$V_{RRM} + 100$	V	
I^2t	I^2t value for fusing tp = 10 ms	72	A ² s	
dI/dt	Critical rate of rise of on-state current ($I_G = 2 \times I_{GT}$)	50	A/ μ s	

I_{GM}	Peak gate current	4	A
P_{G(AV)}	Average gate power dissipation	1	W
P_{GM}	Peak gate power	5	W

Electrical Characteristics : (T_j=25°C unless otherwise specified)

Symbol	Test Condition	Quadrant	Range	Value				Unit
				B	C	S	T	
I_{GT}	V _D =12V R _L =33Ω	I-II-III	MAX	50	35	10	5	mA
V_{GT}		I-II-III	MAX	1.3				V
V_{GD}	V _D =V _{DRM} R _L =3.3kΩ T _j =125°C	I-II-III	MIN	0.2				V
I_L	I _G =1.2 I _{GT}	I-III	MAX	70	50	25	10	mA
		II		80	60	30	15	
I_H	I _{TM} = 100mA		MAX	60	40	15	10	mA
dV/dt	V _D =2/3V _{DRM} Gate Open T _j =125°C		MIN	1000	500	40	20	V/μs
(dV/dt)_c	without snubber T _j =125°C		MIN	12	6.5	5.0	3.5	V/μs

Static Characteristics

Symbol	Parameter		Value(MAX)	Unit
V_{TM}	I _{TM} =17A t _p = 380μs	T _j =25°C	1.55	V
I_{DRM} I_{RRM}	V _D =V _{DRM} , V _R =V _{R_{RRM}}	T _j =25°C	5	μ A
		T _j =125°C	1	mA

Thermal Resistances :

Symbol	Parameter		Value	Unit
R_{th(j-c)}	Junction to case for AC	TO-263	0.95	°C/W
		TO-220BC(Non-Ins)	1.4	

FIG.1 Maximum power dissipation versus RMS on-state current

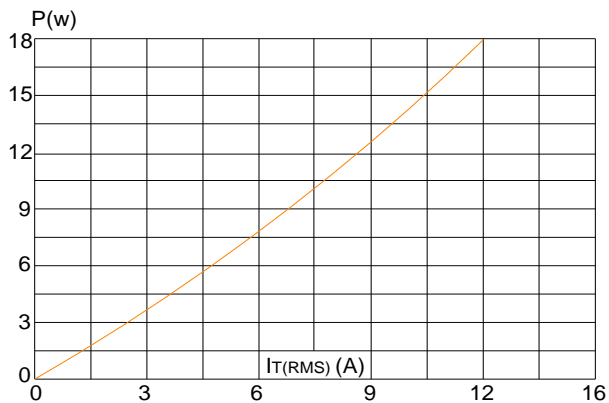

FIG.2: RMS on-state current versus case temperature

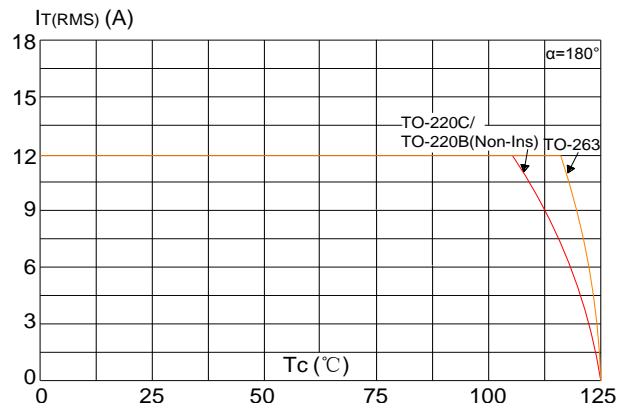

FIG.3: Surge peak on-state current versus number of cycles

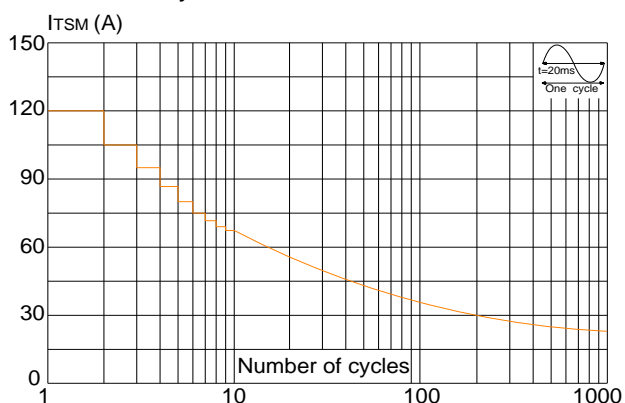

FIG.4: On-state characteristics (maximum values)

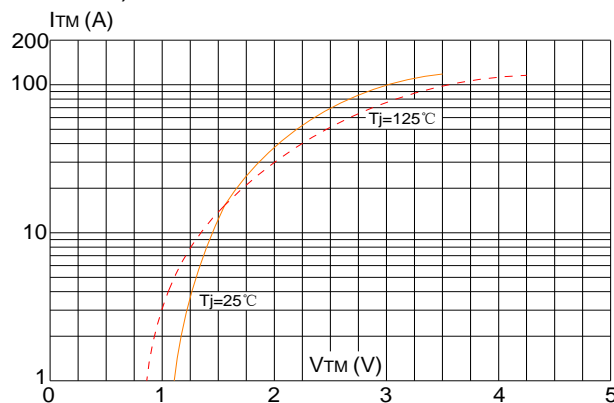

FIG.5: Non-repetitive surge peak on-state current for a sinusoidal pulse with width $t_p < 20\text{ms}$, and corresponding value of I^2t ($di/dt < 50\text{A}/\mu\text{s}$)

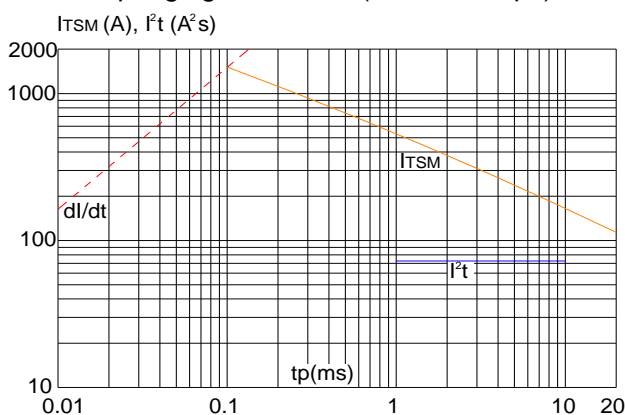
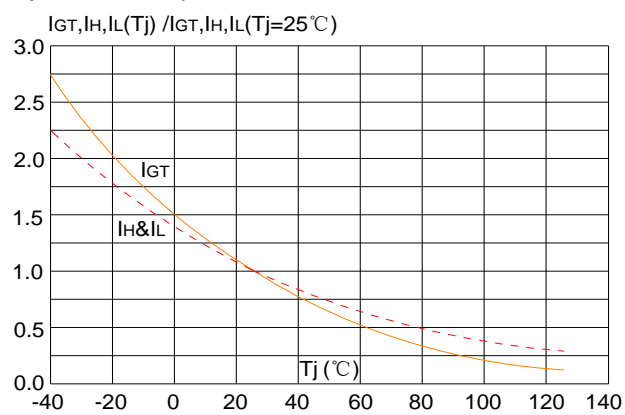
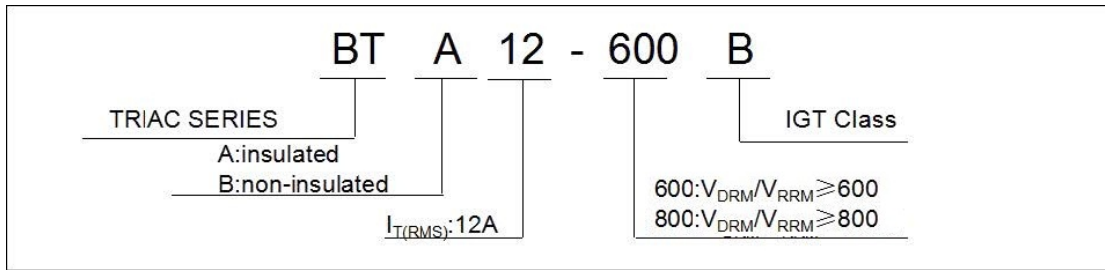

FIG.6: Relative variations of gate trigger current, holding current and latching current versus junction temperature



Ordering Information:



Package Mechanical Data :

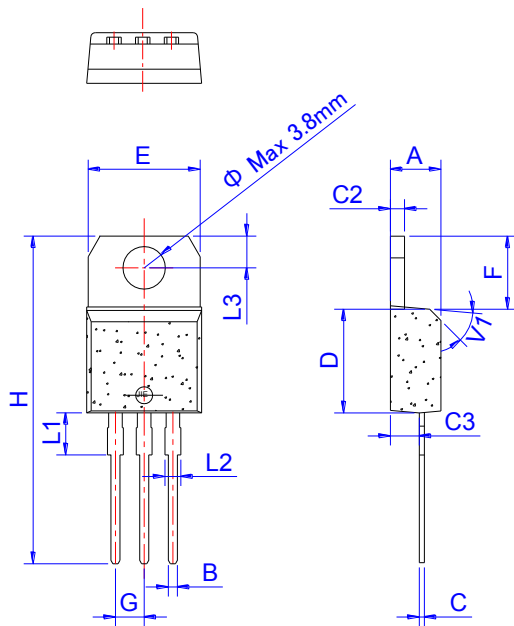

TO-220B

Ref.	Dimensions					
	Millimeters			Inches		
	Min.	Typ.	Max.	Min.	Typ.	Max.
A	4.40		4.60	0.173		0.181
B	0.61		0.88	0.024		0.035
C	0.46		0.70	0.018		0.028
C2	1.21		1.32	0.048		0.052
C3	2.40		2.72	0.094		0.107
D	8.60		9.70	0.339		0.382
E	9.60		10.4	0.378		0.409
F	6.20		6.60	0.244		0.260
G		2.54			0.1	
H	28.0		29.8	1.102		1.173
L1		3.75			0.148	
L2	1.14		1.70	0.045		0.067
L3	2.65		2.95	0.104		0.116
V1		45°			45°	

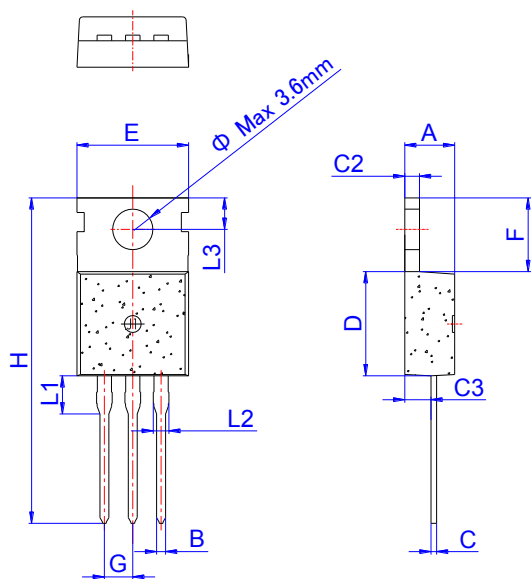

TO-220C

Ref.	Dimensions					
	Millimeters			Inches		
	Min.	Typ.	Max.	Min.	Typ.	Max.
A	4.40		4.60	0.173		0.181
B	0.70		0.90	0.028		0.035
C	0.45		0.60	0.018		0.024
C2	1.23		1.32	0.048		0.052
C3	2.20		2.60	0.087		0.102
D	8.90		9.90	0.350		0.390
E	9.90		10.3	0.390		0.406
F	6.30		6.90	0.248		0.272
G		2.54			0.1	
H	28.0		29.8	1.102		1.173
L1		3.39			0.133	
L2	1.14		1.70	0.045		0.067
L3	2.65		2.95	0.104		0.116
Φ		3.6			0.142	

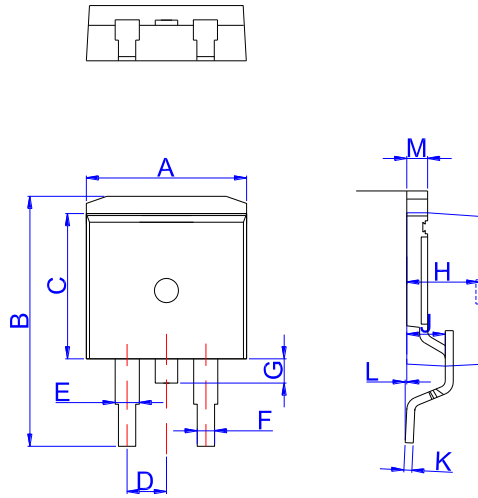

TO-263

Ref.	Dimensions					
	Millimeters			Inches		
	Min.	Typ.	Max.	Min.	Typ.	Max.
A	9.90		10.20	0.390		0.402
B	14.70		15.80	0.579		0.622
C	9.4		9.6	0.37		0.378
D		2.54			0.100	
E	1.20		1.40	0.047		0.055
F	0.75		0.85	0.029		0.033
G			1.75			0.069
H	4.40		4.70	0.173		0.185
J	2.30		2.70	0.091		0.106
K	0.38		0.55	0.015		0.022
L	0	0.10	0.25	0	0.004	0.010
M	1.25		1.35	0.049		0.053