

Description

The device provides simple and performance electronics ballast control function for the half bridge L/C resonant inverter. This device is optimized for electronics ballast requiring a minimum board area, reduced component count and low power dissipation. Internal soft start circuitry eliminates the need for an external soft start PTC resistor. The initial soft start frequency and soft start time can be easily adjusted depending on the types of lamp. Prevent burning out of switches in no lamp condition. Internal 18V regulator clamps Vcc line of supply voltage for eliminating an external zener diode.

Features

- No lamp protection
- Low Start up & Operating Current
- Internal Soft Start
- Flexible Soft Start Frequency
- Trimmed 1.5% internal Reference
- Under Voltage Lock Out with Hysteresis
- High Current Totem Pole Gate Drive

Ordering Information

Type NO.	Marking	Package Code
S6510	S6510	SOP-8

Outline Dimensions

unit : mm

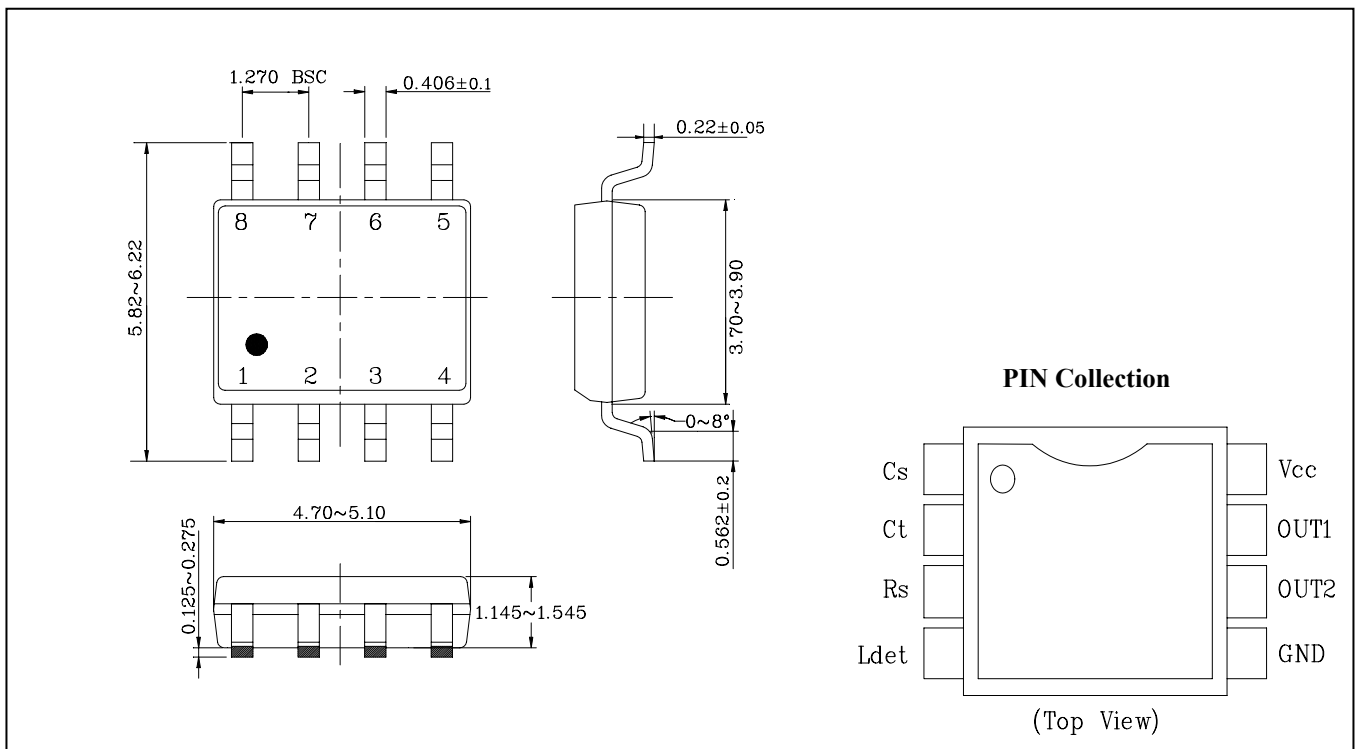

Internal Block Diagram

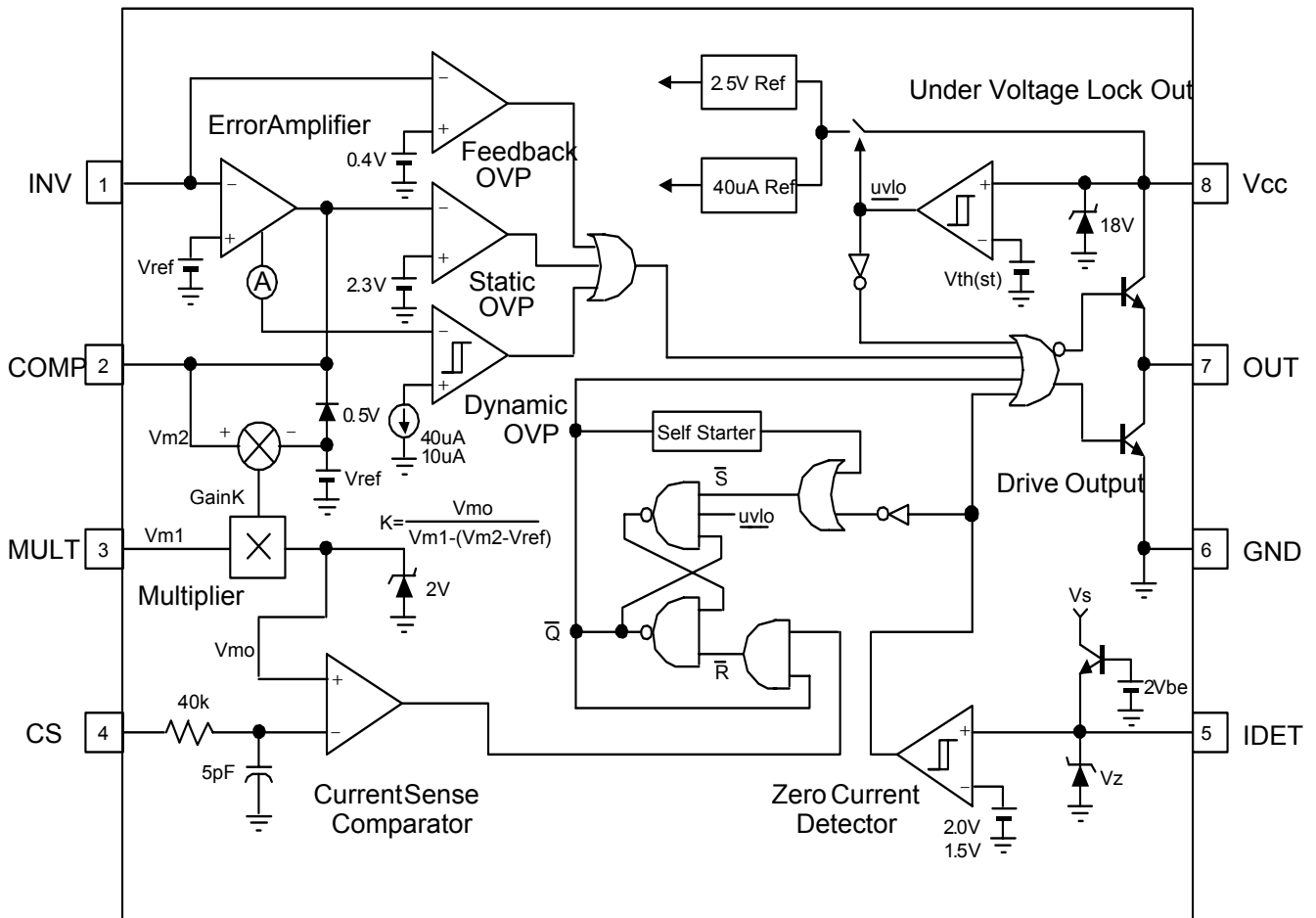

PIN Collection

Pin Number	Pin Name	Pin Function Description
1	Cs	Soft start time capacitor connection pin. The pin charge time to Vref determines The preheating time of lamp.
2	CT	Timing capacitor connection pin. The timing capacitor is charged and discharged To generate the sawtooth waveform that determines the oscillator frequency in the internal oscillator.
3	Rs	Soft start resistor connection pin. The soft start resistor value determines the initial soft start frequency for preheating.
4	Ldet	Input to the protection circuit. If the pin voltage is lower than Vref, the output oh The output driver1,2 is inhibited.
5	GND	Ground of the control Section.
6	OUT2	Gate drive output. A push pull output stage is able to drive the Power MOSFET With peak current of 400mA.
7	OUT1	Gate drive output. A push pull output stage is able to drive the Power MOSFET With peak current of 400mA.
8	Vcc	Supply Voltage of output driver and control circuits.

ABSOLUTE MAXIMUM RATINGS

CHARACTERISTICS	SYMBOL	VALUE	UNITS
Supply Voltage	Vcc	18	V
Peak Drive Output Current	Ioh, IoI	± 400	mA
Driver Output Clamping Diodes $V_o > V_{cc}$ or $V_o < -0.3V$	Iclamp	± 10	mA
Soft Start and No lamp detection Input Voltage	Vin	-0.3 to 6	V
Power Dissipation	Pd	0.8	W

THERMAL DATA

THERMAL RESISTANCE JUNCTION-AMBIENT	Rth(j-amb)	100	°C/W
-------------------------------------	------------	-----	------

Electrical Characteristics

Vcc=12V, 0°C ≤ Ta ≤ 105°C, unless otherwise stated.

Characteristic	Symbol	Test Condition	Min.	Typ.	Max.	Unit
SUPPLY VOLTAGE & CURRENT SECTION						
Start Threshold Voltage	Vth(st)	Vcc Increasing	9.5	10.5	11.5	V
UVLO Hysteresis	HT(st)	-	1.5	2.5	3.5	V
Start up Supply Current	Ist	Vcc=9V	20	50	80	uA
Operating Supply Current	Icc	Output not switching	-	3	6	mA
Dynamic Operating Supply Current	Idcc	50kHz, CI=1nF	-	5	10	mA
Maximum Supply Voltage	Vcc(max)	Icc=30mA	17	18	19	V
ERROR AMPLIFIER SECTION						
Voltage Feedback Input Threshold	Vref	Iref=0mA, Ta=25°C	1.95	2	2.05	V
Line Regulation	△Vref1	12V ≤ Vcc ≤ 17V	0	0.1	10	mV
Temperature Stability of Vref	△Vref2	Temp= 0°C to 75°C	-	15	-	mV
SOFT START SECTION						
Soft start Timing Current	Ics	Cs=0V, Ct=0V	0.5	2.5	5	uA
Rs Buffer Voltage	Vrs	Rs=22K	1.9	2	2.1	V
OSCILLATOR SECTION						
Operating Frequency	fos	Vcs=3V, Ct=470pF	40	45	50	kHz
Operating Dead Time	tod	Vcs=3V, Ct=470pF	1	1.5	2	us
Soft Start Frequency	fss	Vcs=0V, Rs=22K	65	70	75	kHz
Initial Soft Start Dead Time	tsd	Vcs=0V, Rs=22K	0.5	1	1.5	us

Electrical Characteristics

$V_{CC}=12V$, $0^{\circ}C \leq T_a \leq 105^{\circ}C$, unless otherwise stated.

Characteristic	Symbol	Test Condition	Min.	Typ.	Max.	Unit
OUTPUT SECTION						
Output Voltage High	Voh	$I_o=-10mA$	8.5	10	-	V
Output Voltage Low	Vol	$I_o=10mA$	-	0.5	2	V
Rising Time	tr	CI=1nF	-	200	300	ns
Falling Time	tf	CI=1nF	-	50	100	ns
Output Voltage with UVLO Activated	Vo(uvlo)	$V_{CC}=5V$, $I_o=50\mu A$	-	-	1	V
PROTECTION SECTION						
No Lamp Detect Voltage	Vnd	-	1.9	2	2.1	V

Electrical Characteristic Curves

Fig. 1 Start up Supply Current vs. Supply Voltage

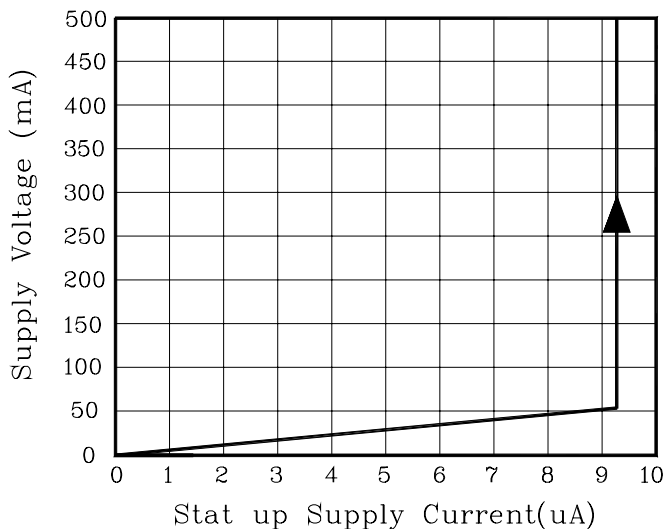

Fig. 2 Operating Supply Current vs. Supply Voltage

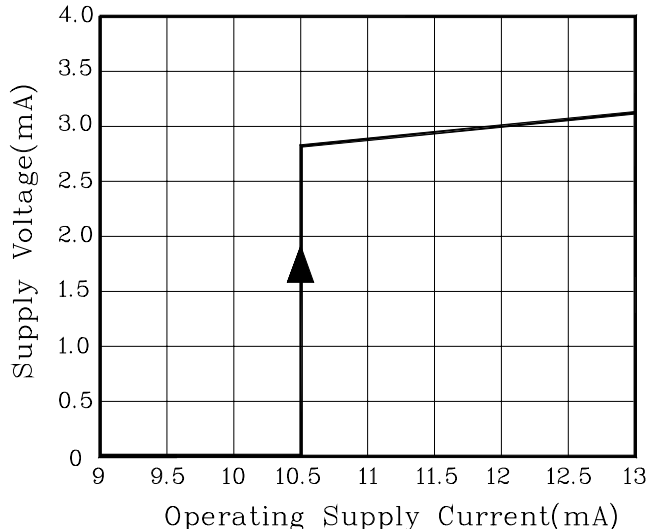

Fig. 3 UVLO Hysteresis vs. Supply Current

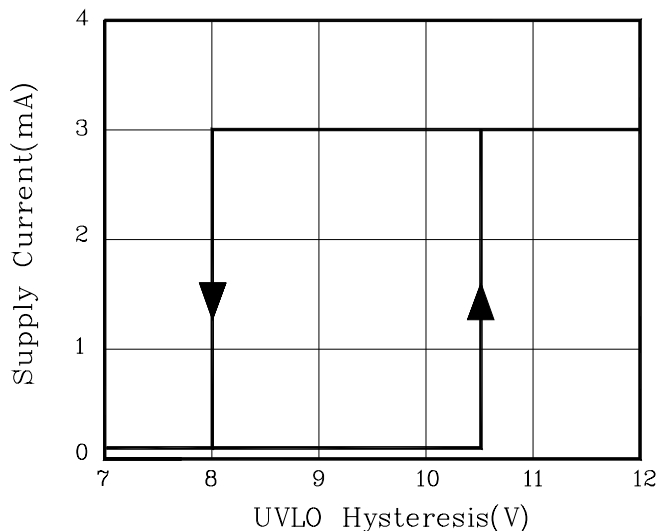

Fig. 4 No Lamp Detect Voltage vs. Ldet Input Voltage

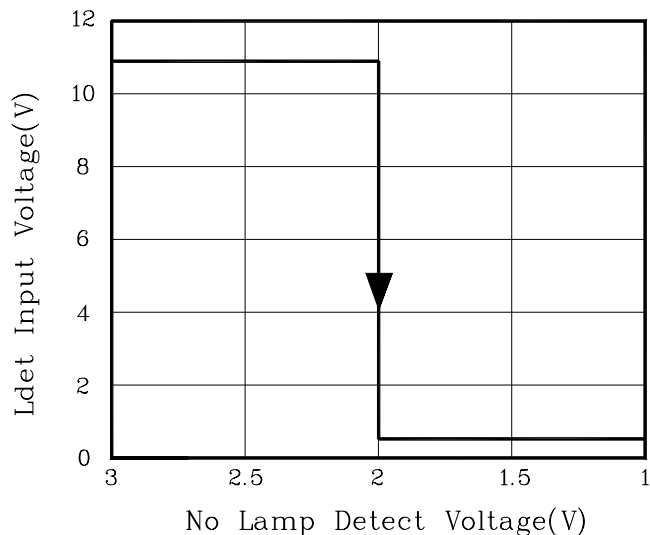
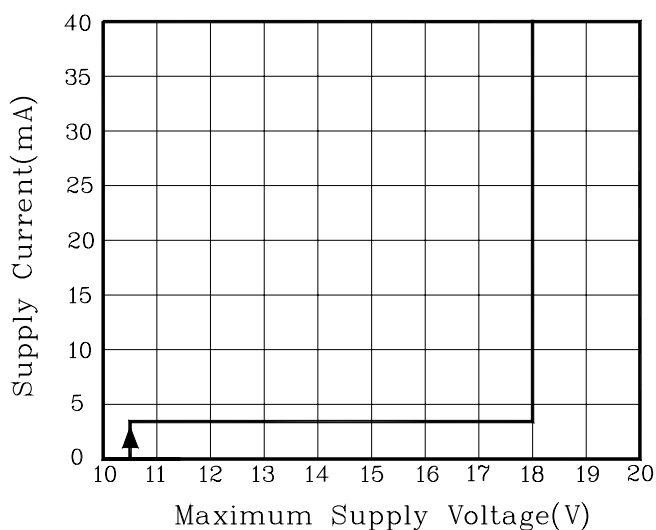

Fig. 5 Maximum Supply Voltage vs. Supply Current



These AUK products are intended for usage in general electronic equipments(Office and communication equipment, measuring equipment, domestic electrification, etc.).

Please make sure that you consult with us before you use these AUK products in equipments which require high quality and/or reliability, and in equipments which could have major impact to the welfare of human life(atomic energy control, airplane, spaceship, traffic signal, combustion central, all types of safety device, etc.).

AUK cannot accept liability to any damage which may occur in case these AUK products were used in the mentioned equipments without prior consultation with AUK.