

**REPETITIVE AVALANCHE AND dv/dt RATED
 HEXFET® TRANSISTORS
 THRU-HOLE - TO-205AF (TO-39)**

**IRFF230
 JANTX2N6798
 JANTXV2N6798
 REF:MIL-PRF-19500/557
 200V, N-CHANNEL**

Product Summary

Part Number	BVDSS	RDS(on)	Id
IRFF230	200V	0.40Ω	5.5A



The HEXFET® technology is the key to International Rectifier's advanced line of power MOSFET transistors. The efficient geometry and unique processing of this latest "State of the Art" design achieves: very low on-state resistance combined with high transconductance.

The HEXFET transistors also feature all of the well established advantages of MOSFETs such as voltage control, very fast switching, ease of paralleling and temperature stability of the electrical parameters.

They are well suited for applications such as switching power supplies, motor controls, inverters, choppers, audio amplifiers and high energy pulse circuits.

Features:

- Repetitive Avalanche Ratings
- Dynamic dv/dt Rating
- Hermetically Sealed
- Simple Drive Requirements
- Ease of Paralleling
- ESD Rating: Class 1C per MIL-STD-750, Method 1020

Absolute Maximum Ratings

	Parameter		Units
I_D @ $V_{GS} = 10V, T_C = 25^\circ C$	Continuous Drain Current	5.5	A
I_D @ $V_{GS} = 10V, T_C = 100^\circ C$	Continuous Drain Current	3.5	
I_{DM}	Pulsed Drain Current ①	22	
P_D @ $T_C = 25^\circ C$	Max. Power Dissipation	25	W
	Linear Derating Factor	0.20	W/°C
V_{GS}	Gate-to-Source Voltage	±20	V
EAS	Single Pulse Avalanche Energy ②	207.5	mJ
IAR	Avalanche Current ①	5.5	A
EAR	Repetitive Avalanche Energy ①	2.5	mJ
dv/dt	Peak Diode Recovery dv/dt ③	4.5	V/ns
T_J	Operating Junction	-55 to 150	°C
T_{STG}	Storage Temperature Range		
	Lead Temperature	300 (0.063 in. (1.6mm) from case for 10s)	
	Weight	0.98 (typical)	g

For footnotes refer to the last page

Electrical Characteristics @ T_j = 25°C (Unless Otherwise Specified)

	Parameter	Min	Typ	Max	Units	Test Conditions
B _V DSS	Drain-to-Source Breakdown Voltage	200	—	—	V	V _{GS} = 0V, I _D = 1.0mA
ΔB _V DSS/ΔT _J	Temperature Coefficient of Breakdown Voltage	—	0.25	—	V/°C	Reference to 25°C, I _D = 1.0mA
R _{DS(on)}	Static Drain-to-Source On-State Resistance	—	—	0.40	Ω	V _{GS} = 10V, I _D = 3.5A ④
		—	—	0.46		V _{GS} = 10V, I _D = 5.5A ④
V _{GS(th)}	Gate Threshold Voltage	2.0	—	4.0	V	V _{DS} = V _{GS} , I _D = 250μA
g _{fs}	Forward Transconductance	2.5	—	—	S	V _{DS} = 15V, I _{DS} = 3.5A ④
I _{DSS}	Zero Gate Voltage Drain Current	—	—	25	μA	V _{DS} = 160V, V _{GS} = 0V
		—	—	250		V _{DS} = 160V V _{GS} = 0V, T _J = 125°C
I _{GSS}	Gate-to-Source Leakage Forward	—	—	100	nA	V _{GS} = 20V
I _{GSS}	Gate-to-Source Leakage Reverse	—	—	-100	nA	V _{GS} = -20V
Q _g	Total Gate Charge	7.4	—	42.1	nC	V _{GS} = 10V, I _D = 5.5A V _{DS} = 100V
Q _{gs}	Gate-to-Source Charge	2.5	—	5.3		
Q _{gd}	Gate-to-Drain ('Miller') Charge	6.0	—	28		
t _{d(on)}	Turn-On Delay Time	—	—	30	ns	V _{DD} = 100V, I _D = 5.5A, V _{GS} = 10V, R _G = 7.5Ω
t _r	Rise Time	—	—	50		
t _{d(off)}	Turn-Off Delay Time	—	—	50		
t _f	Fall Time	—	—	40		
LS + LD	Total Inductance	—	7.0	—	nH	Measured from drain lead (6mm/0.25in. from package) to source lead (6mm/0.25in. from package)
C _{iss}	Input Capacitance	—	600	—	pF	V _{GS} = 0V, V _{DS} = 25V f = 1.0MHz
C _{oss}	Output Capacitance	—	250	—		
C _{rss}	Reverse Transfer Capacitance	—	80	—		

Source-Drain Diode Ratings and Characteristics

	Parameter	Min	Typ	Max	Units	Test Conditions
I _S	Continuous Source Current (Body Diode)	—	—	5.5	A	
I _{SM}	Pulse Source Current (Body Diode) ①	—	—	22		
V _{SD}	Diode Forward Voltage	—	—	1.4	V	T _j = 25°C, I _S = 5.5A, V _{GS} = 0V ④
t _{rr}	Reverse Recovery Time	—	—	500	ns	T _j = 25°C, I _F = 5.5A, di/dt ≤ 100A/μs
Q _{RR}	Reverse Recovery Charge	—	—	6.0	μC	V _{DD} ≤ 50V ④
t _{on}	Forward Turn-On Time	Intrinsic turn-on time is negligible. Turn-on speed is substantially controlled by LS + LD.				

Thermal Resistance

	Parameter	Min	Typ	Max	Units	Test Conditions
R _{thJC}	Junction-to-Case	—	—	5.0	°C/W	Typical socket mount.
R _{thJA}	Junction-to-Ambient	—	—	175		

Note: Corresponding Spice and Saber models are available on International Rectifier website.

For footnotes refer to the last page

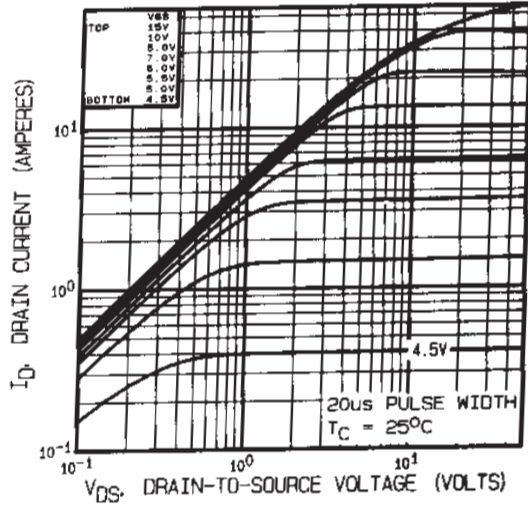

Fig 1. Typical Output Characteristics

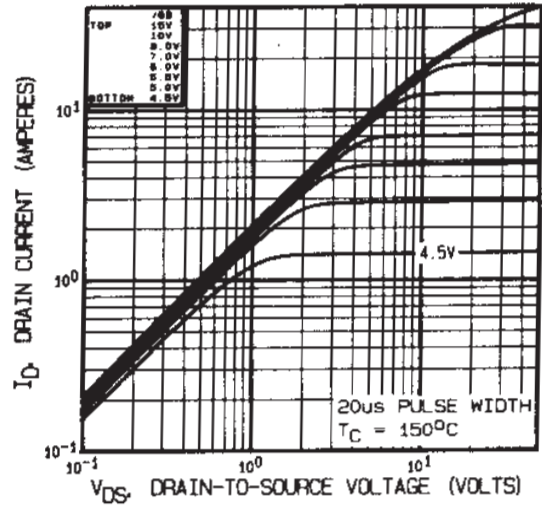

Fig 2. Typical Output Characteristics

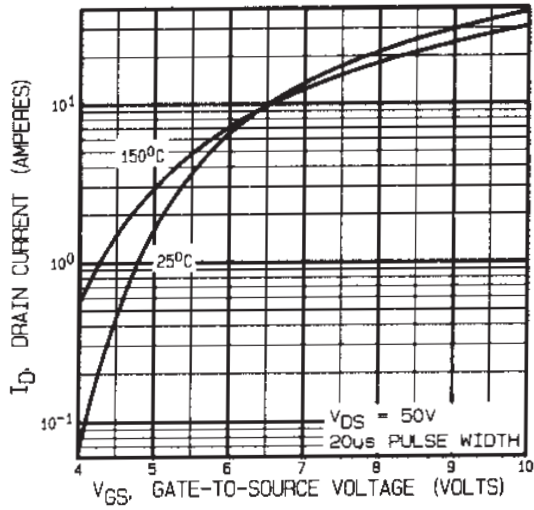

Fig 3. Typical Transfer Characteristics

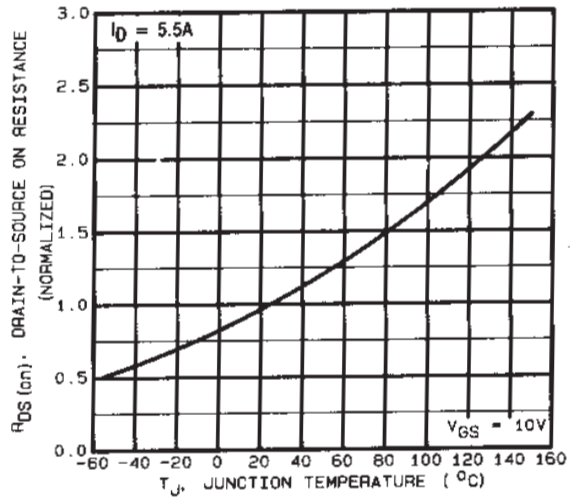

Fig 4. Normalized On-Resistance Vs. Temperature

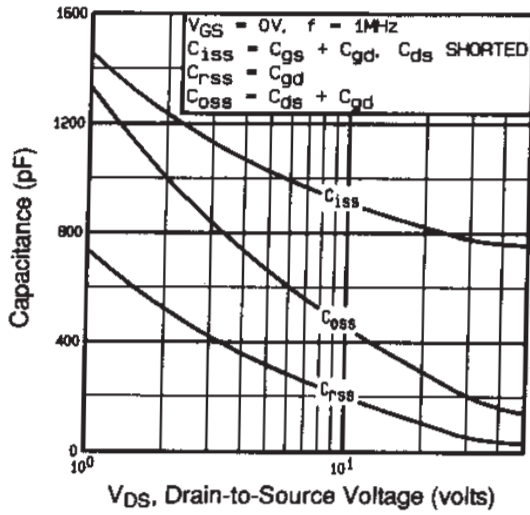

Fig 5. Typical Capacitance Vs. Drain-to-Source Voltage

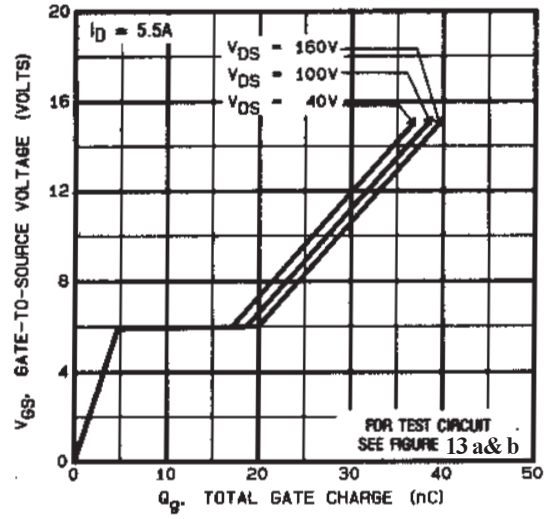

Fig 6. Typical Gate Charge Vs. Gate-to-Source Voltage

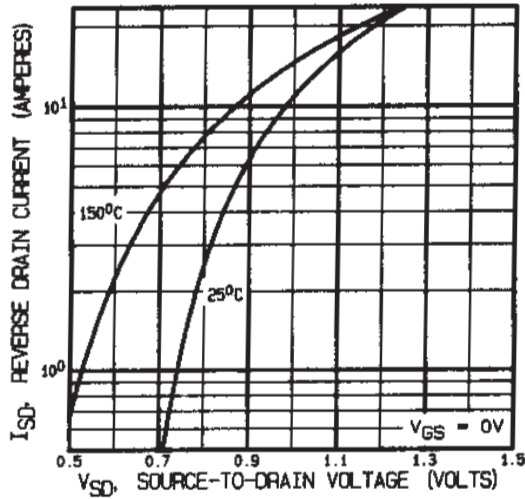

Fig 7. Typical Source-Drain Diode Forward Voltage

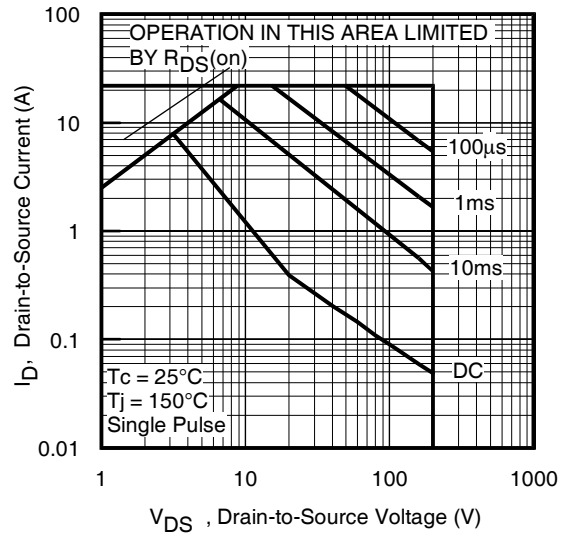

Fig 8. Maximum Safe Operating Area

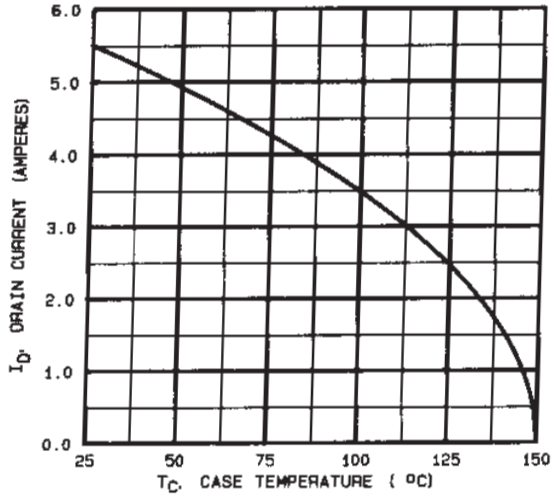

Fig9. Maximum Drain Current Vs. Case Temperature

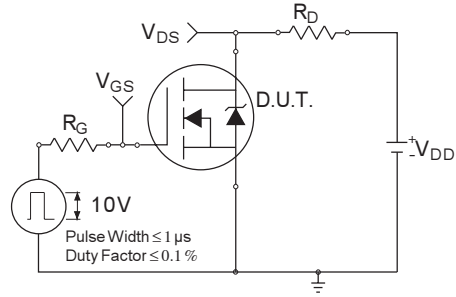

Fig 10a. Switching Time Test Circuit

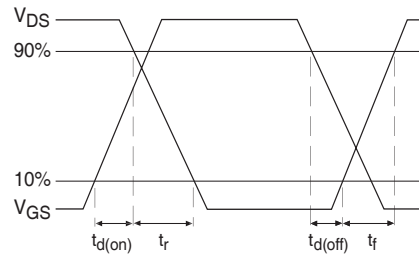

Fig 10b. Switching Time Waveforms

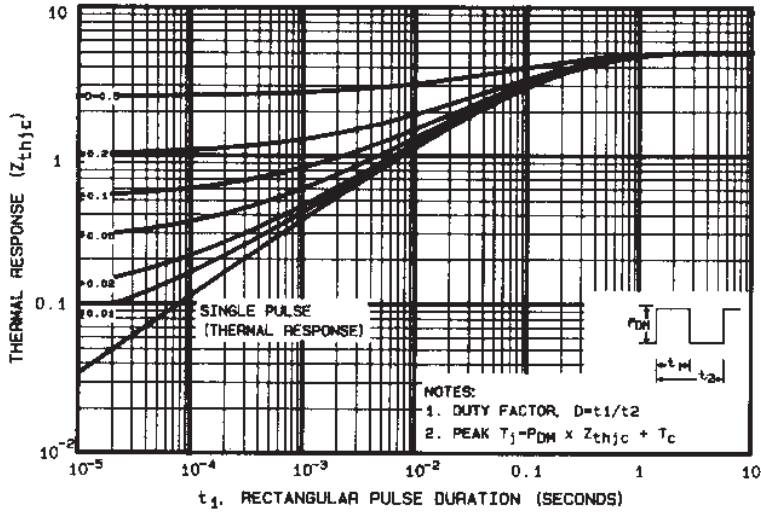

Fig11. Maximum Effective Transient Thermal Impedance, Junction-to-Case

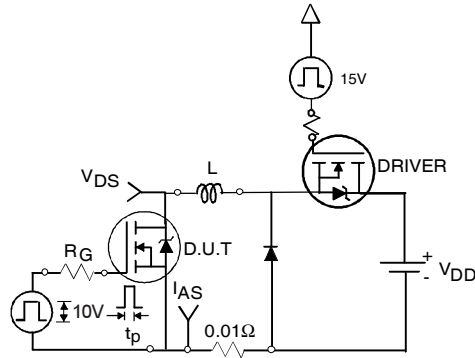

Fig 12a. Unclamped Inductive Test Circuit

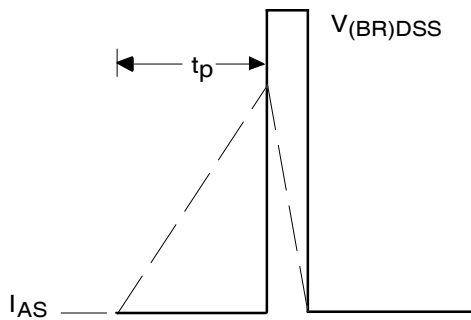

Fig 12b. Unclamped Inductive Waveforms

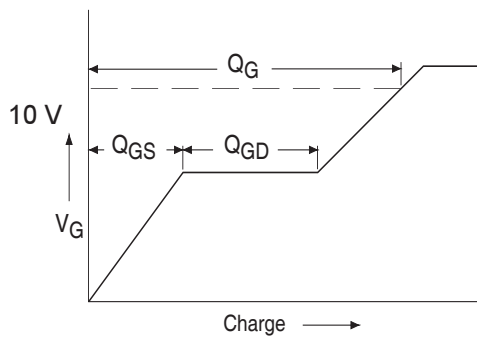

Fig 13a. Basic Gate Charge Waveform

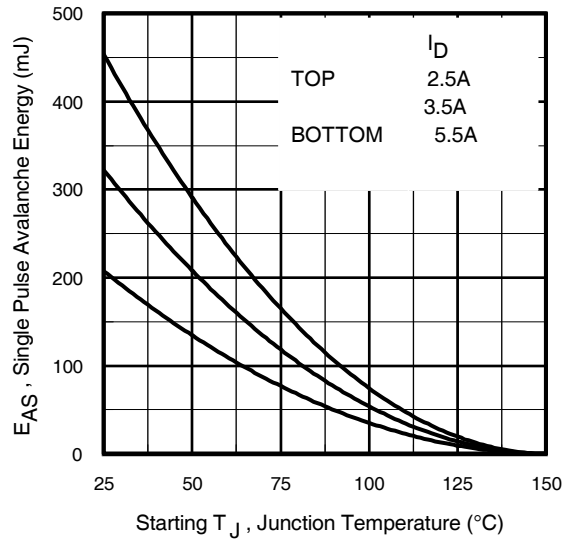

Fig 12c. Maximum Avalanche Energy Vs. Drain Current

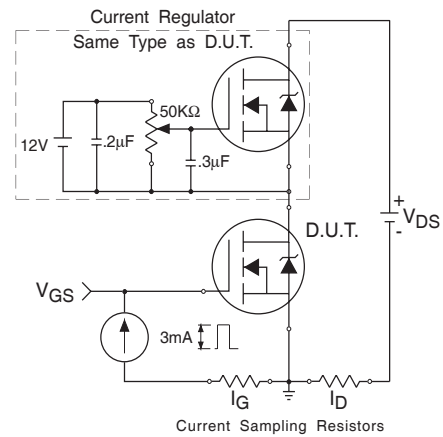
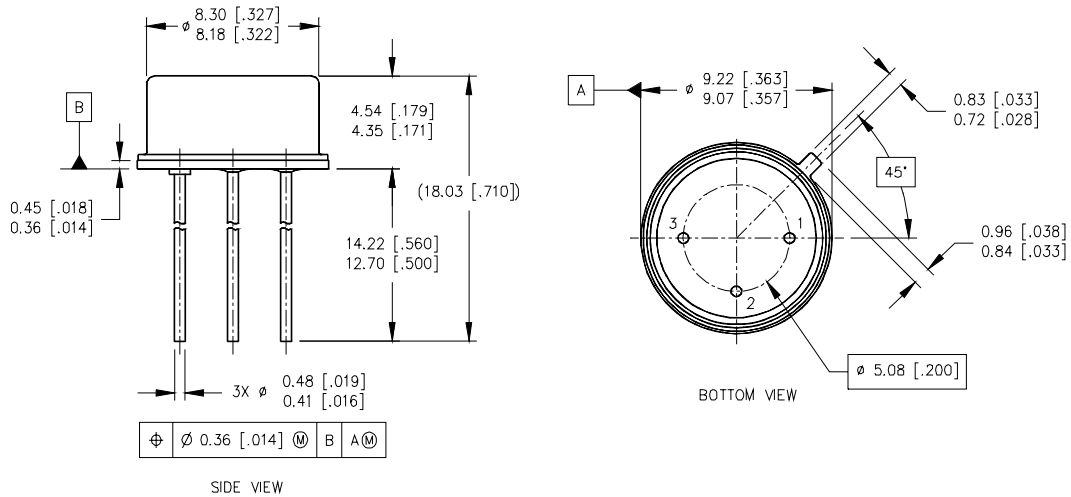

Fig 13b. Gate Charge Test Circuit

Footnotes:

- ① Repetitive Rating; Pulse width limited by maximum junction temperature.
- ② $V_{DD} = 50V$, Starting $T_J = 25^\circ C$, $L=13.7mH$
 Peak $I_{AS} = 5.5A$, $V_{GS} = 10V$, $R_G = 25\Omega$
- ③ $I_{SD} \leq 5.5A$, $di/dt \leq 120A/\mu s$,
 $V_{DD} \leq 200V$, $T_J \leq 150^\circ C$, Suggested $R_G = 7.5 \Omega$
- ④ Pulse width $\leq 300 \mu s$; Duty Cycle $\leq 2\%$

Case Outline and Dimensions —TO-205AF (TO-39)



NOTES:

1. DIMENSIONING AND TOLERANCING PER ASME 14.5M-1994.
2. DIMENSIONS ARE SHOWN IN MILLIMETERS [INCHES].
3. CONTROLLING DIMENSION: INCH.
4. CONFORMS TO JEDEC OUTLINE TO-205AF (TO-39).

LEGEND

- 1- SOURCE
- 2- GATE
- 3- DRAIN