

TPD1028BS

Low-Side Switch for Motors, Solenoids, and Lamp Drivers

TPD1028BS is a monolithic power IC for low-side switch. The IC has a vertical MOSFET output which can be directly driven from a CMOS or TTL logic circuit (e.g., an MPU). The IC offers intelligent self-protection functions.

Features

- A monolithic power IC with a new structure combining a control block and a vertical power MOSFET (n -MOS) on a single chip.
- Can directly drive a power load from a CMOS or TTL logic.
- Built-in Protection circuits against overvoltage, load short circuiting, and thermal shutdown.
- Low on-resistance. $R_{DS(ON)} = 0.25$ (max) (@ $V_{IN} = 5$ V, $T_j = 25^\circ\text{C}$)
- Package TO-92(MOD) can be packed in tape.

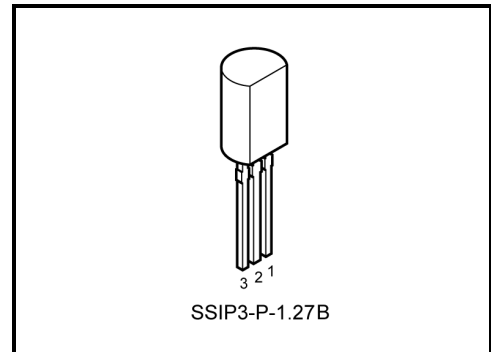

Weight: 0.36 g (typ.)

Pin Assignment

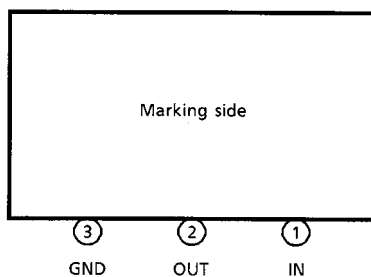

Note: That because of its MOS structure, this product is sensitive to static electricity.

Block Diagram

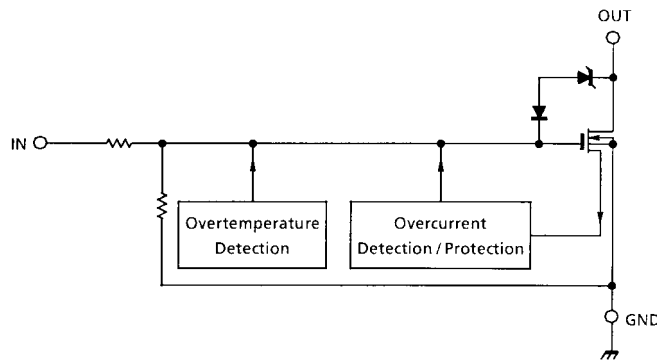

Pin Description

Pin No.	Symbol	Pin Description
1	IN	Input pin. This pin is connected to a pull-down resistor internally, so that even when input wiring is open-circuited, output can never be turned on inadvertently.
2	OUT	Output pin. If an inrush current flows (e.g., from a lamp), the current is clamped at 10 A (typ.) by an overcurrent protective circuit. Also, a 150 μ s (typ.) mask circuit is included internally, so that if $V_{DS} \geq 12$ V (typ.) after this mask time, the current is clamped at 3 A (typ.).
3	GND	Ground pin.

Timing Chart

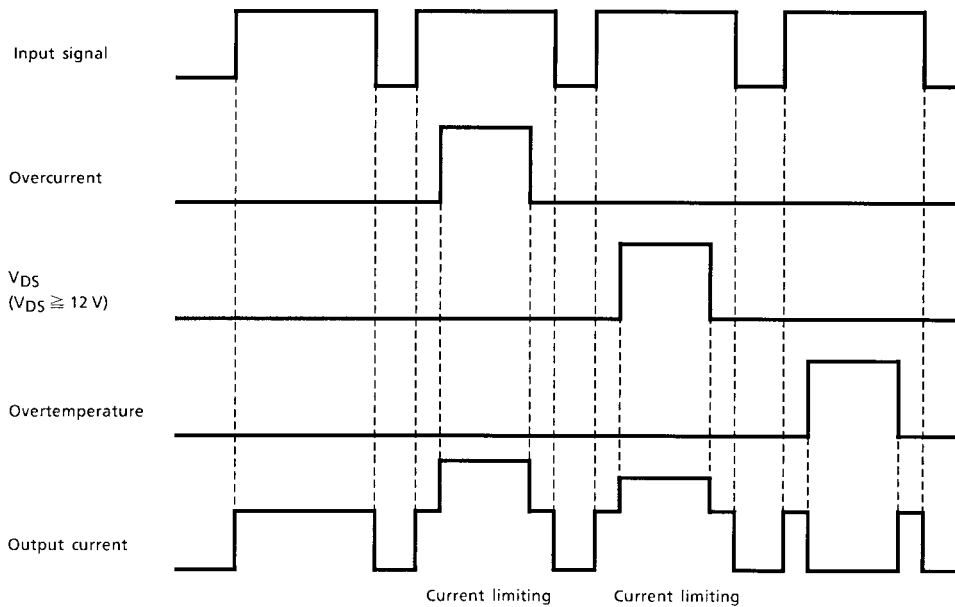

Truth Table

In	Vout	State
L	H	Normal
H	L	
L	H	Overcurrent (during inrush)
H	L	
L	H	Overcurrent (shorted load)
H	L	
L	H	Overtemperature
H	H	

Maximum Rating (Ta = 25°C)

Characteristic	Symbol	Rating	Unit
Drain-source voltage	$V_{DS(DC)}$	40	V
Output current	I_D	1.5	A
Input voltage	V_{IN}	- 0.5 ~ 6	V
Power dissipation	P_D	0.9	W
Energy tolerance	E_S / B	200	mJ
Operating temperature	T_{opr}	- 40 ~ 85	°C
Junction temperature	T_j	150	°C

Electrical Characteristics (T_j = 25°C)

Characteristic	Symbol	Test Circuit	Test Condition	Min	Typ.	Max	Unit
Drain-source breakdown voltage	V _{(BR)DSS}	—	V _{IN} = 0 V, I _D = 10 mA	40	—	—	V
Operating supply voltage	V _{DD}	—	—	—	—	38	V
High level input voltage	V _{IH(1)}	—	V _{DS} = 24 V, I _D = 1 A	4.5	5	5.5	V
	V _{IH(2)}	—	V _{DS} = 10 V, I _D = 0.75 A	3.9	5	5.7	
	V _{IH(3)}	—	V _{DS} = 38 V, I _D = 0.75 A	3.9	5	5.7	
Low level input voltage	V _{IL(1)}	—	V _{DS} = 24 V, I _D = 10 μA	—	—	0.8	V
	V _{IL(2)}	—	V _{DS} = 10 V, I _D = 10 μA	—	—	0.8	
	V _{IL(3)}	—	V _{DS} = 38 V, I _D = 10 μA	—	—	0.8	
Current at output off	I _{DSS(1)}	—	V _{IN} = 0 V, V _{DS} = 40 V	—	—	100	μA
	I _{DSS(2)}	—	V _{IN} = 0 V, V _{DS} = 24 V	—	—	10	
Input current	I _{IN}	—	V _{IN} = 5 V, at normal operation	—	—	300	μA
On resistance	R _{DS(ON)}	—	V _{IN} = 5 V, I _D = 1 A	—	—	0.25	Ω
Thermal shutdown temperature	T _S	—	V _{IN} = 5 V	—	160	—	°C
Overcurrent protection	I _{S(1)}	—	V _{DS} = 24 V, V _{IN} = 5 V, during inrush	—	10	—	A
	I _{S(2)}	—	V _{DS} = 24 V, V _{IN} = 5 V, when shorted load	—	3	—	
Shorted load detection voltage	V _{DS}	—	when shorted load	—	12	—	V
Switching time	t _{ON}	1	V _{DS} = 24 V, V _{IN} = 5 V, R _L = 24 Ω	—	70	—	μs
	t _{OFF}			—	120	—	
Diode forward voltage between drain and source	V _{DSF}	—	I _F = 1.5 A	—	0.9	1.8	V

Test Circuit 1

Switching time measuring circuit

Test circuit

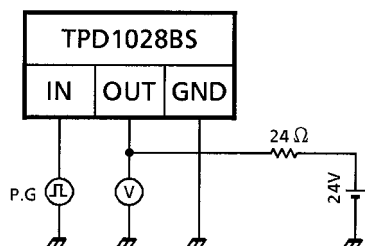

Measured waveforms

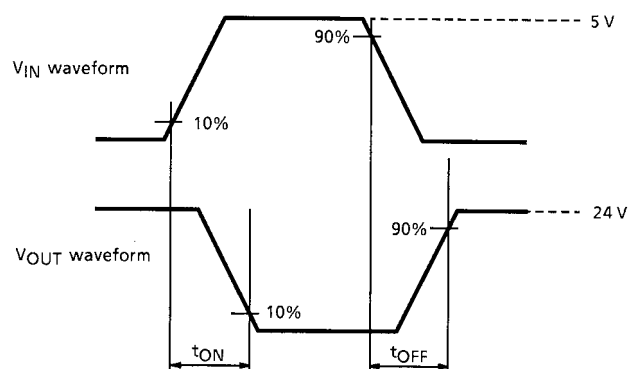

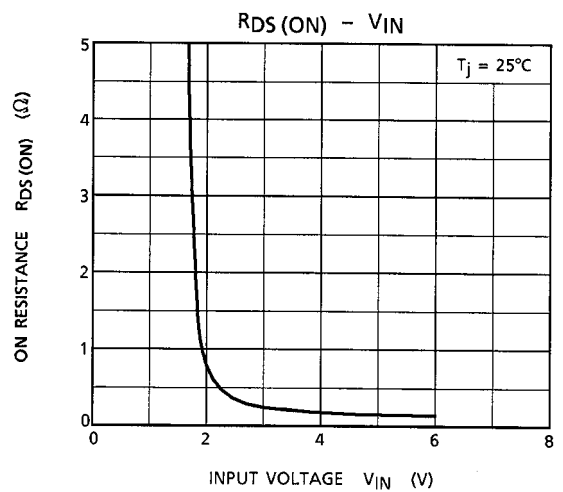
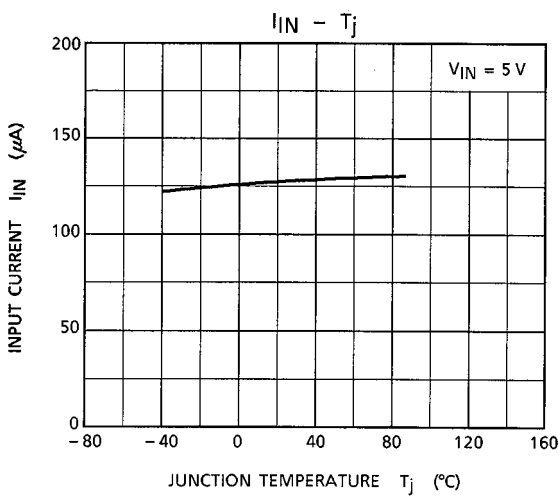
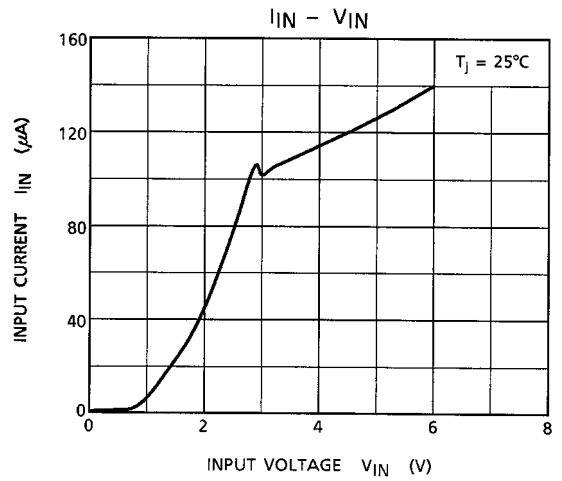
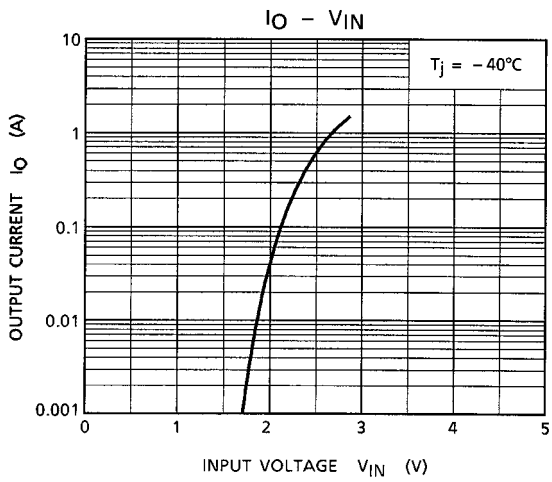
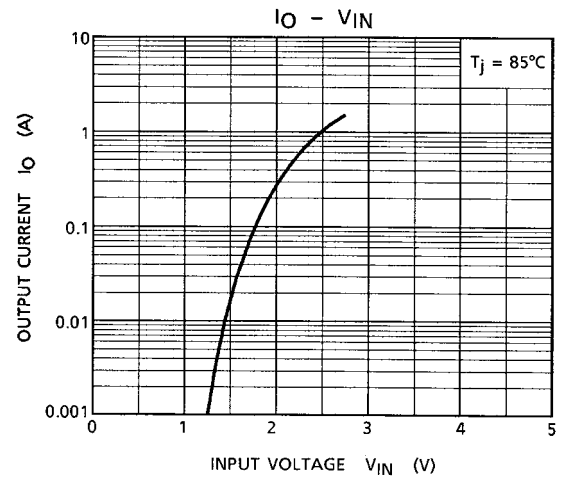
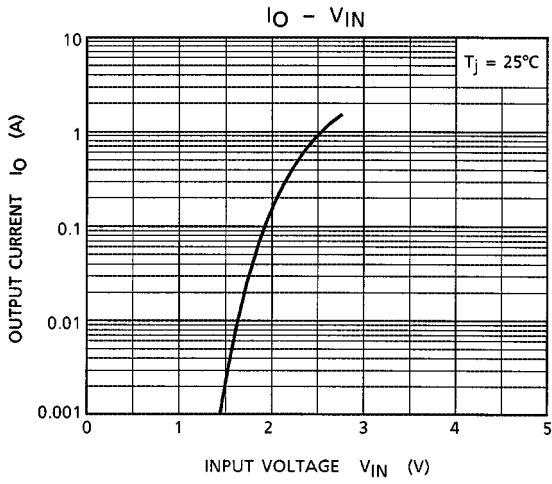

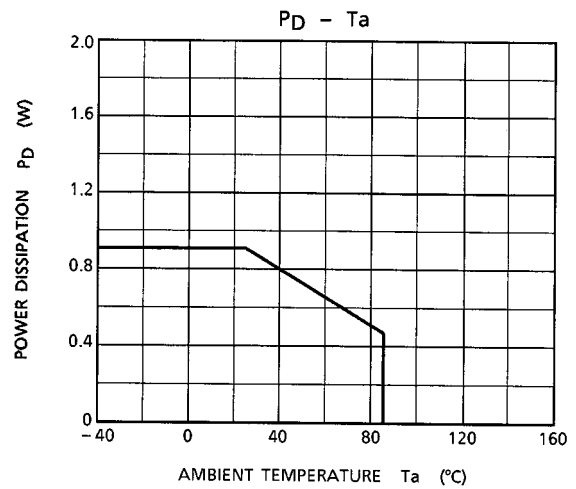
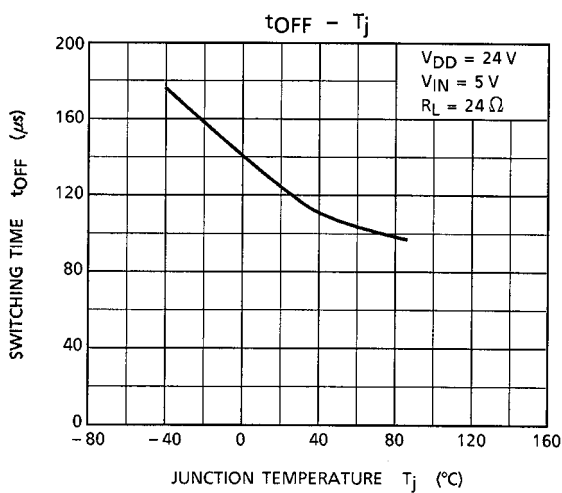
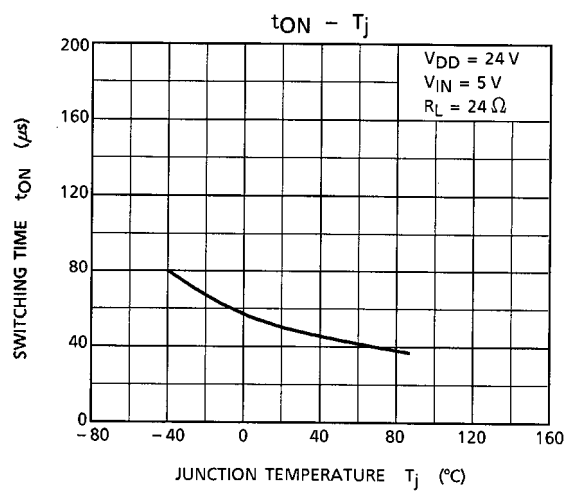
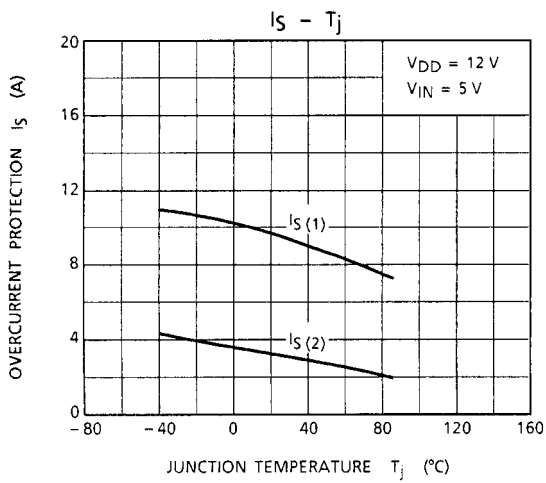
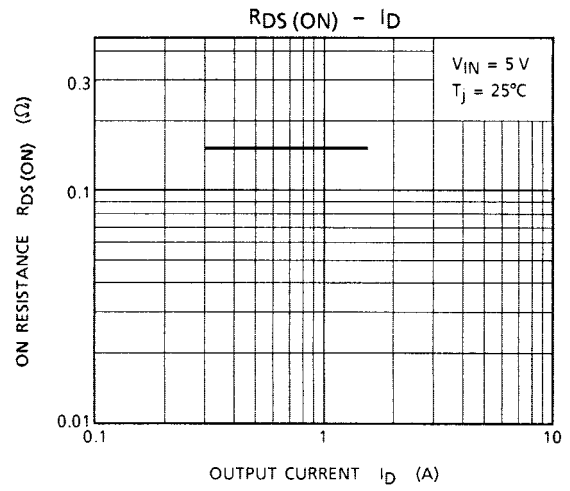
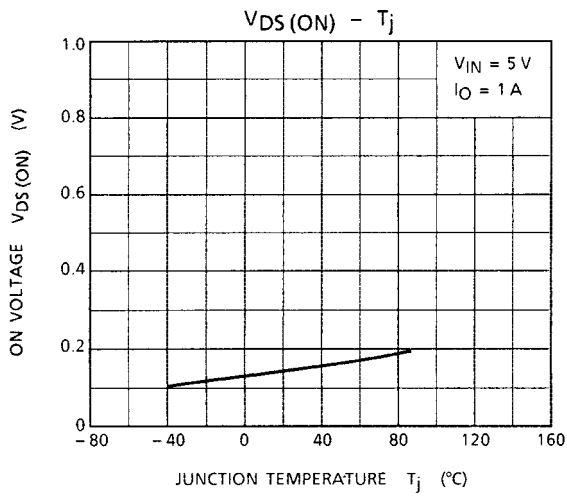

Package Dimensions

SSIP3-P-1.27B

Unit : mm

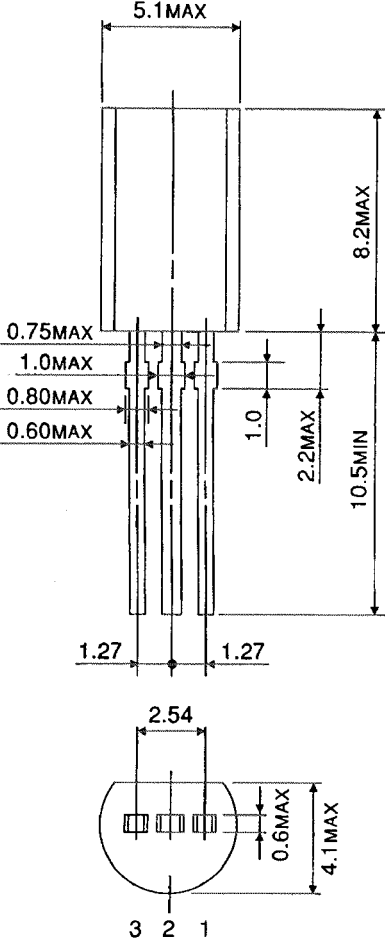

Weight: 0.36 g (typ.)

RESTRICTIONS ON PRODUCT USE

000707EBA

- TOSHIBA is continually working to improve the quality and reliability of its products. Nevertheless, semiconductor devices in general can malfunction or fail due to their inherent electrical sensitivity and vulnerability to physical stress. It is the responsibility of the buyer, when utilizing TOSHIBA products, to comply with the standards of safety in making a safe design for the entire system, and to avoid situations in which a malfunction or failure of such TOSHIBA products could cause loss of human life, bodily injury or damage to property.
In developing your designs, please ensure that TOSHIBA products are used within specified operating ranges as set forth in the most recent TOSHIBA products specifications. Also, please keep in mind the precautions and conditions set forth in the "Handling Guide for Semiconductor Devices," or "TOSHIBA Semiconductor Reliability Handbook" etc..
- The TOSHIBA products listed in this document are intended for usage in general electronics applications (computer, personal equipment, office equipment, measuring equipment, industrial robotics, domestic appliances, etc.). These TOSHIBA products are neither intended nor warranted for usage in equipment that requires extraordinarily high quality and/or reliability or a malfunction or failure of which may cause loss of human life or bodily injury ("Unintended Usage"). Unintended Usage include atomic energy control instruments, airplane or spaceship instruments, transportation instruments, traffic signal instruments, combustion control instruments, medical instruments, all types of safety devices, etc.. Unintended Usage of TOSHIBA products listed in this document shall be made at the customer's own risk.
- The products described in this document are subject to the foreign exchange and foreign trade laws.
- The information contained herein is presented only as a guide for the applications of our products. No responsibility is assumed by TOSHIBA CORPORATION for any infringements of intellectual property or other rights of the third parties which may result from its use. No license is granted by implication or otherwise under any intellectual property or other rights of TOSHIBA CORPORATION or others.
- The information contained herein is subject to change without notice.