

MC10EP57, MC100EP57

3.3V / 5V ECL 4:1 Differential Multiplexer

Description

The MC10/100EP57 is a fully differential 4:1 multiplexer. By leaving the SEL1 line open (pulled LOW via the input pulldown resistors) the device can also be used as a differential 2:1 multiplexer with SEL0 input selecting between D0 and D1. The fully differential architecture of the EP57 makes it ideal for use in low skew applications such as clock distribution.

The SEL1 is the most significant select line. The binary number applied to the select inputs will select the same numbered data input (i.e., 00 selects D0).

Multiple V_{BB} outputs are provided. The V_{BB} pin, an internally generated voltage supply, is available to this device only. For single-ended input conditions, the unused differential input is connected to V_{BB} as a switching reference voltage. V_{BB} may also rebias AC coupled inputs. When used, decouple V_{BB} and V_{CC} via a 0.01 μF capacitor and limit current sourcing or sinking to 0.5 mA. When not used, V_{BB} should be left open.

The 100 Series contains temperature compensation.

Features

- 375 ps Typical Propagation Delays
- Maximum Frequency > 2 GHz Typical
- PECL Mode Operating Range:
 $V_{CC} = 3.0\text{ V to } 5.5\text{ V}$ with $V_{EE} = 0\text{ V}$
- NECL Mode Operating Range:
 $V_{CC} = 0\text{ V}$ with $V_{EE} = -3.0\text{ V to } -5.5\text{ V}$
- Open Input Default State
- Safety Clamp on Inputs
- Q Output will default LOW with inputs open or at V_{EE}
- V_{BB} Outputs
- Useful as Either 4:1 or 2:1 Multiplexer
- These Devices are Pb-Free and are RoHS Compliant



ON Semiconductor®

<http://onsemi.com>

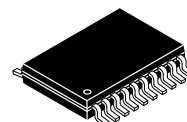

TSSOP-20
DT SUFFIX
CASE 948E

MARKING DIAGRAM*

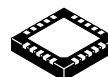
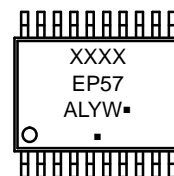

QFN-20
MN SUFFIX
CASE 485E

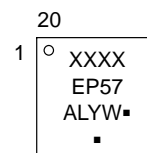

xxx = MC10 or 100
A = Assembly Location
L = Wafer Lot
Y = Year
W = Work Week
▪ = Pb-Free Package

(Note: Microdot may be in either location)

*For additional marking information, refer to Application Note AND8002/D.

ORDERING INFORMATION

See detailed ordering and shipping information in the package dimensions section on page 8 of this data sheet.

MC10EP57, MC100EP57

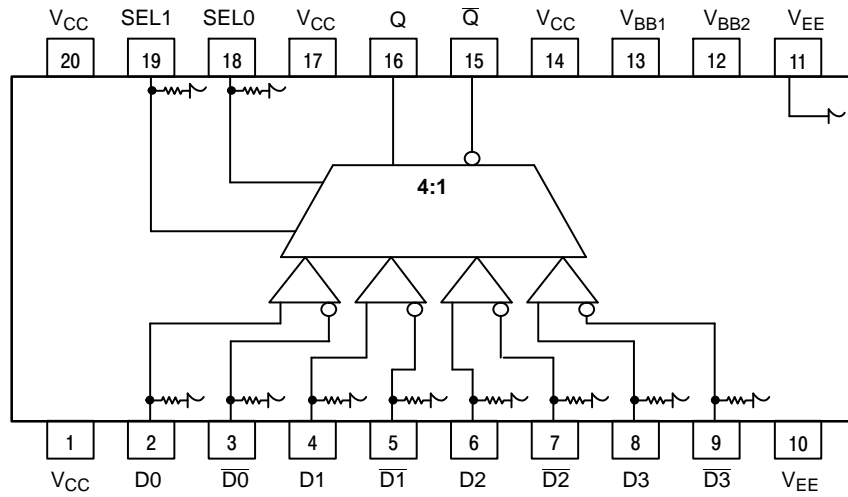

Warning: All V_{CC} and V_{EE} pins must be externally connected to Power Supply to guarantee proper operation.

Figure 1. 20-Lead Package (Top View) and Logic Diagram

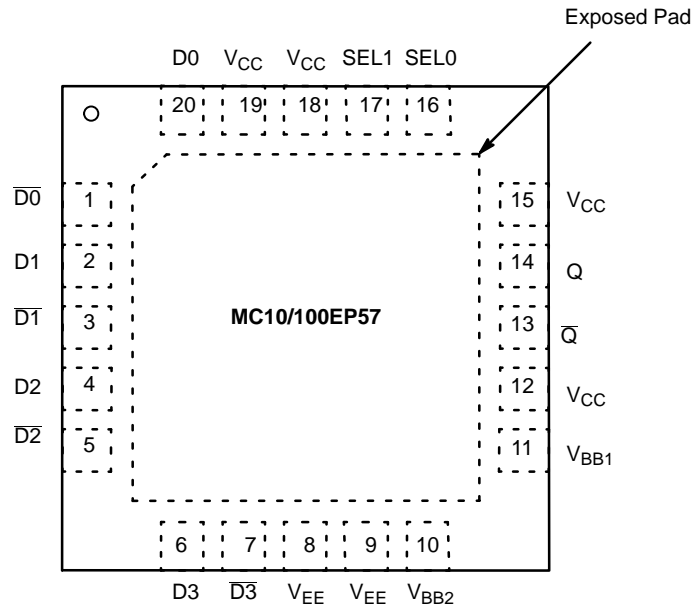

NOTE: The Exposed Pad (EP) on package bottom must be attached to a heat-sinking conduit. The Exposed Pad may only be electrically connected to V_{EE} .

Figure 1. QFN-20 Pinout (Top View)

Table 1. PIN DESCRIPTION

PIN	FUNCTION
D0 – 3*, $\overline{D0} - 3^*$	ECL Differential Data Inputs
SEL0*, SEL1*	ECL MUX Select Inputs
V_{BB1} , V_{BB2}	ECL Reference Output Voltage
Q, \overline{Q}	ECL Data Outputs
V_{CC}	Positive Supply
V_{EE}	Negative Supply
EP	Exposed Pad

*Pins will default LOW when left open.

Table 2. TRUTH TABLE

SEL1	SEL0	DATA OUT
L	L	D0, $\overline{D0}$
L	H	D1, $\overline{D1}$
H	L	D2, $\overline{D2}$
H	H	D3, $\overline{D3}$

MC10EP57, MC100EP57

Table 3. ATTRIBUTES

Characteristics		Value	
Internal Input Pulldown Resistor		75 kΩ	
Internal Input Pullup Resistor		N/A	
ESD Protection	Human Body Model Machine Model Charged Device Model	> 4 kV > 100 V > 2 kV	
Moisture Sensitivity, Indefinite Time Out of Drypack (Note 1)		Pb Pkg	Pb-Free Pkg
		TSSOP-20 QFN-20	Level 1 N/A Level 3 Level 1
Flammability Rating	Oxygen Index: 28 to 34	UL 94 V-0 @ 0.125 in	
Transistor Count		584 Devices	
Meets or exceeds JEDEC Spec EIA/JESD78 IC Latchup Test			

1. For additional information, see Application Note AND8003/D.

Table 4. MAXIMUM RATINGS

Symbol	Parameter	Condition 1	Condition 2	Rating	Unit
V _{CC}	PECL Mode Power Supply	V _{EE} = 0 V		6	V
V _{EE}	NECL Mode Power Supply	V _{CC} = 0 V		-6	V
V _I	PECL Mode Input Voltage NECL Mode Input Voltage	V _{EE} = 0 V V _{CC} = 0 V	V _I ≤ V _{CC} V _I ≥ V _{EE}	6 -6	V V
I _{out}	Output Current	Continuous Surge		50 100	mA mA
I _{BB}	V _{BB} Sink/Source			± 0.5	mA
T _A	Operating Temperature Range			-40 to +85	°C
T _{stg}	Storage Temperature Range			-65 to +150	°C
θ _{JA}	Thermal Resistance (Junction-to-Ambient)	0 lfpm 500 lfpm	TSSOP-20 TSSOP-20	140 100	°C/W °C/W
θ _{JC}	Thermal Resistance (Junction-to-Case)	Standard Board	TSSOP-20	23 to 41	°C/W
θ _{JA}	Thermal Resistance (Junction-to-Ambient)	0 lfpm 500 lfpm	QFN-20 QFN-20	47 33	°C/W °C/W
θ _{JC}	Thermal Resistance (Junction-to-Case)	Standard Board	QFN-20	18	°C/W
T _{sol}	Wave Solder	Pb Pb-Free		265 265	°C

Stresses exceeding Maximum Ratings may damage the device. Maximum Ratings are stress ratings only. Functional operation above the Recommended Operating Conditions is not implied. Extended exposure to stresses above the Recommended Operating Conditions may affect device reliability.

MC10EP57, MC100EP57

Table 5. 10EP DC CHARACTERISTICS, PECL $V_{CC} = 3.3\text{ V}$, $V_{EE} = 0\text{ V}$ (Note 2)

Symbol	Characteristic	-40°C			25°C			85°C			Unit
		Min	Typ	Max	Min	Typ	Max	Min	Typ	Max	
I_{EE}	Power Supply Current	40	52	65	40	52	65	40	52	65	mA
V_{OH}	Output HIGH Voltage (Note 3)	2165	2290	2415	2230	2355	2480	2290	2415	2540	mV
V_{OL}	Output LOW Voltage (Note 3)	1365	1490	1615	1430	1555	1680	1490	1615	1740	mV
V_{IH}	Input HIGH Voltage (Single-Ended)	2090		2415	2155		2480	2215		2540	mV
V_{IL}	Input LOW Voltage (Single-Ended)	1365		1690	1460		1755	1490		1815	mV
V_{BB}	Output Voltage Reference	1790	1835	1990	1855	1900	2055	1915	1960	2115	mV
V_{IHCMR}	Input HIGH Voltage Common Mode Range (Differential Configuration) (Note 4)	2.0		3.3	2.0		3.3	2.0		3.3	V
I_{IH}	Input HIGH Current			150			150			150	μA
I_{IL}	Input LOW Current	0.5			0.5			0.5			μA

NOTE: Device will meet the specifications after thermal equilibrium has been established when mounted in a test socket or printed circuit board with maintained transverse airflow greater than 500 lfm. Electrical parameters are guaranteed only over the declared operating temperature range. Functional operation of the device exceeding these conditions is not implied. Device specification limit values are applied individually under normal operating conditions and not valid simultaneously.

- Input and output parameters vary 1:1 with V_{CC} . V_{EE} can vary +0.3 V to -2.2 V.
- All loading with $50\ \Omega$ to $V_{CC} - 2.0\text{ V}$.
- V_{IHCMR} min varies 1:1 with V_{EE} , V_{IHCMR} max varies 1:1 with V_{CC} . The V_{IHCMR} range is referenced to the most positive side of the differential input signal.

Table 6. 10EP DC CHARACTERISTICS, PECL $V_{CC} = 5.0\text{ V}$, $V_{EE} = 0\text{ V}$ (Note 5)

Symbol	Characteristic	-40°C			25°C			85°C			Unit
		Min	Typ	Max	Min	Typ	Max	Min	Typ	Max	
I_{EE}	Power Supply Current	40	52	65	40	52	65	40	52	65	mA
V_{OH}	Output HIGH Voltage (Note 6)	3865	3990	4115	3930	4055	4180	3990	4115	4240	mV
V_{OL}	Output LOW Voltage (Note 6)	3065	3190	3315	3130	3255	3380	3190	3315	3440	mV
V_{IH}	Input HIGH Voltage (Single-Ended)	3790		4115	3855		4180	3915		4240	mV
V_{IL}	Input LOW Voltage (Single-Ended)	3065		3390	3130		3455	3190		3515	mV
V_{BB}	Output Voltage Reference	3490	3535	3690	3555	3600	3755	3685	3660	3815	mV
V_{IHCMR}	Input HIGH Voltage Common Mode Range (Differential Configuration) (Note 7)	2.0		5.0	2.0		5.0	2.0		5.0	V
I_{IH}	Input HIGH Current			150			150			150	μA
I_{IL}	Input LOW Current	0.5			0.5			0.5			μA

NOTE: Device will meet the specifications after thermal equilibrium has been established when mounted in a test socket or printed circuit board with maintained transverse airflow greater than 500 lfm. Electrical parameters are guaranteed only over the declared operating temperature range. Functional operation of the device exceeding these conditions is not implied. Device specification limit values are applied individually under normal operating conditions and not valid simultaneously.

- Input and output parameters vary 1:1 with V_{CC} . V_{EE} can vary +2.0 V to -0.5 V.
- All loading with $50\ \Omega$ to $V_{CC} - 2.0\text{ V}$.
- V_{IHCMR} min varies 1:1 with V_{EE} , V_{IHCMR} max varies 1:1 with V_{CC} . The V_{IHCMR} range is referenced to the most positive side of the differential input signal.

MC10EP57, MC100EP57

Table 7. 10EP DC CHARACTERISTICS, NECL $V_{CC} = 0\text{ V}$, $V_{EE} = -5.5\text{ V}$ to -3.0 V (Note 8)

Symbol	Characteristic	-40°C			25°C			85°C			Unit
		Min	Typ	Max	Min	Typ	Max	Min	Typ	Max	
I_{EE}	Power Supply Current	40	52	65	40	52	65	40	52	65	mA
V_{OH}	Output HIGH Voltage (Note 9)	-1135	-1010	-885	-1070	-945	-820	-1010	-885	-760	mV
V_{OL}	Output LOW Voltage (Note 9)	-1935	-1810	-1685	-1870	-1745	-1620	-1810	-1685	-1560	mV
V_{IH}	Input HIGH Voltage (Single-Ended)	-1210		-885	-1145		-820	-1085		-760	mV
V_{IL}	Input LOW Voltage (Single-Ended)	-1935		-1610	-1870		-1545	-1810		-1485	mV
V_{BB}	Output Voltage Reference	-1510	-1465	-1310	-1445	-1400	-1245	-1385	-1340	-1185	mV
V_{IHCMR}	Input HIGH Voltage Common Mode Range (Differential Configuration) (Note 10)	$V_{EE} + 2.0$		0.0	$V_{EE} + 2.0$		0.0	$V_{EE} + 2.0$		0.0	V
I_{IH}	Input HIGH Current			150			150			150	μA
I_{IL}	Input LOW Current	0.5			0.5			0.5			μA

NOTE: Device will meet the specifications after thermal equilibrium has been established when mounted in a test socket or printed circuit board with maintained transverse airflow greater than 500 lpm. Electrical parameters are guaranteed only over the declared operating temperature range. Functional operation of the device exceeding these conditions is not implied. Device specification limit values are applied individually under normal operating conditions and not valid simultaneously.

8. Input and output parameters vary 1:1 with V_{CC} .

9. All loading with $50\ \Omega$ to $V_{CC} - 2.0\text{ V}$.

10. V_{IHCMR} min varies 1:1 with V_{EE} , V_{IHCMR} max varies 1:1 with V_{CC} . The V_{IHCMR} range is referenced to the most positive side of the differential input signal.

Table 8. 100EP DC CHARACTERISTICS, PECL $V_{CC} = 3.3\text{ V}$, $V_{EE} = 0\text{ V}$ (Note 11)

Symbol	Characteristic	-40°C			25°C			85°C			Unit
		Min	Typ	Max	Min	Typ	Max	Min	Typ	Max	
I_{EE}	Power Supply Current	40	52	65	40	52	65	40	52	65	mA
V_{OH}	Output HIGH Voltage (Note 12)	2155	2280	2405	2155	2280	2405	2155	2280	2405	mV
V_{OL}	Output LOW Voltage (Note 12)	1305	1480	1605	1305	1480	1605	1305	1480	1605	mV
V_{IH}	Input HIGH Voltage (Single-Ended)	2075		2420	2075		2420	2075		2420	mV
V_{IL}	Input LOW Voltage (Single-Ended)	1305		1675	1305		1675	1305		1675	mV
V_{BB}	Output Voltage Reference	1775	1875	1975	1775	1875	1975	1775	1875	1975	mV
V_{IHCMR}	Input HIGH Voltage Common Mode Range (Differential Configuration) (Note 13)	2.0		3.3	2.0		3.3	2.0		3.3	V
I_{IH}	Input HIGH Current			150			150			150	μA
I_{IL}	Input LOW Current	0.5			0.5			0.5			μA

NOTE: Device will meet the specifications after thermal equilibrium has been established when mounted in a test socket or printed circuit board with maintained transverse airflow greater than 500 lpm. Electrical parameters are guaranteed only over the declared operating temperature range. Functional operation of the device exceeding these conditions is not implied. Device specification limit values are applied individually under normal operating conditions and not valid simultaneously.

11. Input and output parameters vary 1:1 with V_{CC} . V_{EE} can vary +0.3 V to -2.2 V.

12. All loading with $50\ \Omega$ to $V_{CC} - 2.0\text{ V}$.

13. V_{IHCMR} min varies 1:1 with V_{EE} , V_{IHCMR} max varies 1:1 with V_{CC} . The V_{IHCMR} range is referenced to the most positive side of the differential input signal.

MC10EP57, MC100EP57

Table 9. 100EP DC CHARACTERISTICS, PECL $V_{CC} = 5.0\text{ V}$, $V_{EE} = 0\text{ V}$ (Note 14)

Symbol	Characteristic	-40°C			25°C			85°C			Unit
		Min	Typ	Max	Min	Typ	Max	Min	Typ	Max	
I_{EE}	Power Supply Current	40	52	65	40	52	65	40	52	65	mA
V_{OH}	Output HIGH Voltage (Note 15)	3855	3980	4105	3855	3980	4105	3855	3980	4105	mV
V_{OL}	Output LOW Voltage (Note 15)	3005	3180	3305	3005	3180	3305	3005	3180	3305	mV
V_{IH}	Input HIGH Voltage (Single-Ended)	3775		4120	3775		4120	3775		4120	mV
V_{IL}	Input LOW Voltage (Single-Ended)	3005		3375	3005		3375	3005		3375	mV
V_{BB}	Output Voltage Reference	3475	3575	3675	3475	3575	3675	3475	3575	3675	mV
V_{IHCMR}	Input HIGH Voltage Common Mode Range (Differential Configuration) (Note 16)	2.0		5.0	2.0		5.0	2.0		5.0	V
I_{IH}	Input HIGH Current			150			150			150	μA
I_{IL}	Input LOW Current	0.5			0.5			0.5			μA

NOTE: Device will meet the specifications after thermal equilibrium has been established when mounted in a test socket or printed circuit board with maintained transverse airflow greater than 500 lpm. Electrical parameters are guaranteed only over the declared operating temperature range. Functional operation of the device exceeding these conditions is not implied. Device specification limit values are applied individually under normal operating conditions and not valid simultaneously.

14. Input and output parameters vary 1:1 with V_{CC} . V_{EE} can vary +2.0 V to -0.5 V.

15. All loading with 50 Ω to $V_{CC} - 2.0\text{ V}$.

16. V_{IHCMR} min varies 1:1 with V_{EE} . V_{IHCMR} max varies 1:1 with V_{CC} . The V_{IHCMR} range is referenced to the most positive side of the differential input signal.

Table 10. 100EP DC CHARACTERISTICS, NECL $V_{CC} = 0\text{ V}$, $V_{EE} = -5.5\text{ V}$ to -3.0 V (Note 17)

Symbol	Characteristic	-40°C			25°C			85°C			Unit
		Min	Typ	Max	Min	Typ	Max	Min	Typ	Max	
I_{EE}	Power Supply Current	40	52	65	40	52	65	40	52	65	mA
V_{OH}	Output HIGH Voltage (Note 18)	-1145	-1020	-895	-1145	-1020	-895	-1145	-1020	-895	mV
V_{OL}	Output LOW Voltage (Note 18)	-1995	-1820	-1695	-1995	-1820	-1695	-1995	-1820	-1695	mV
V_{IH}	Input HIGH Voltage (Single-Ended)	-1225		-880	-1225		-880	-1225		-880	mV
V_{IL}	Input LOW Voltage (Single-Ended)	-1995		-1625	-1995		-1625	-1995		-1625	mV
V_{BB}	Output Voltage Reference	-1525	-1425	-1325	-1525	-1425	-1325	-1525	-1425	-1325	mV
V_{IHCMR}	Input HIGH Voltage Common Mode Range (Differential Configuration) (Note 19)	$V_{EE} + 2.0$		0.0	$V_{EE} + 2.0$		0.0	$V_{EE} + 2.0$		0.0	V
I_{IH}	Input HIGH Current			150			150			150	μA
I_{IL}	Input LOW Current	0.5			0.5			0.5			μA

NOTE: Device will meet the specifications after thermal equilibrium has been established when mounted in a test socket or printed circuit board with maintained transverse airflow greater than 500 lpm. Electrical parameters are guaranteed only over the declared operating temperature range. Functional operation of the device exceeding these conditions is not implied. Device specification limit values are applied individually under normal operating conditions and not valid simultaneously.

17. Input and output parameters vary 1:1 with V_{CC} .

18. All loading with 50 Ω to $V_{CC} - 2.0\text{ V}$.

19. V_{IHCMR} min varies 1:1 with V_{EE} . V_{IHCMR} max varies 1:1 with V_{CC} . The V_{IHCMR} range is referenced to the most positive side of the differential input signal.

MC10EP57, MC100EP57

Table 11. AC CHARACTERISTICS $V_{CC} = 0\text{ V}$; $V_{EE} = -3.0\text{ V to } -5.5\text{ V}$ or $V_{CC} = 3.0\text{ V to } 5.5\text{ V}$; $V_{EE} = 0\text{ V}$ (Note 20)

Symbol	Characteristic	-40°C			25°C			85°C			Unit
		Min	Typ	Max	Min	Typ	Max	Min	Typ	Max	
f_{max}	Maximum Frequency (Figure 2)		> 3			> 3			> 3		GHz
t_{PLH} , t_{PHL}	Propagation Delay to Output Differential D to Q, \bar{Q} COM_SEL, SEL to Q, \bar{Q}	250 300	350 400	450 500	275 320	375 420	475 520	320 320	420 450	520 575	ps
t_{SKEW}	Device to Device Skew (Note 21)			200			200			200	ps
t_{JITTER}	CLOCK Random Jitter (RMS) @ $\leq 0.5\text{ GHz}$ @ $\leq 1.0\text{ GHz}$ @ $\leq 1.5\text{ GHz}$ @ $\leq 2.0\text{ GHz}$ @ $\leq 2.5\text{ GHz}$ @ $\leq 3.0\text{ GHz}$		0.122 0.110 0.112 0.128 0.114 0.116	0.3 0.3 0.3 0.3 0.3 0.3		0.140 0.135 0.132 0.139 0.129 0.152	0.3 0.3 0.3 0.3 0.3 0.3		0.172 0.151 0.152 0.163 0.177 0.305	0.3 0.3 0.3 0.3 0.3 1.0	ps
V_{PP}	Input Voltage Swing (Differential Configuration)	150	800	1200	150	800	1200	150	800	1200	mV
t_r , t_f	Output Rise/Fall Times (20% – 80%) Q, \bar{Q}	70	120	170	70	140	200	70	150	220	ps

NOTE: Device will meet the specifications after thermal equilibrium has been established when mounted in a test socket or printed circuit board with maintained transverse airflow greater than 500 lpm. Electrical parameters are guaranteed only over the declared operating temperature range. Functional operation of the device exceeding these conditions is not implied. Device specification limit values are applied individually under normal operating conditions and not valid simultaneously.

20. Measured using a 750 mV source, 50% duty cycle clock source. All loading with $50\ \Omega$ to $V_{CC} - 2.0\text{ V}$.

21. Skew is measured between outputs under identical transitions. Duty cycle skew is defined only for differential operation when the delays are measured from the cross point of the inputs to the cross point of the outputs.

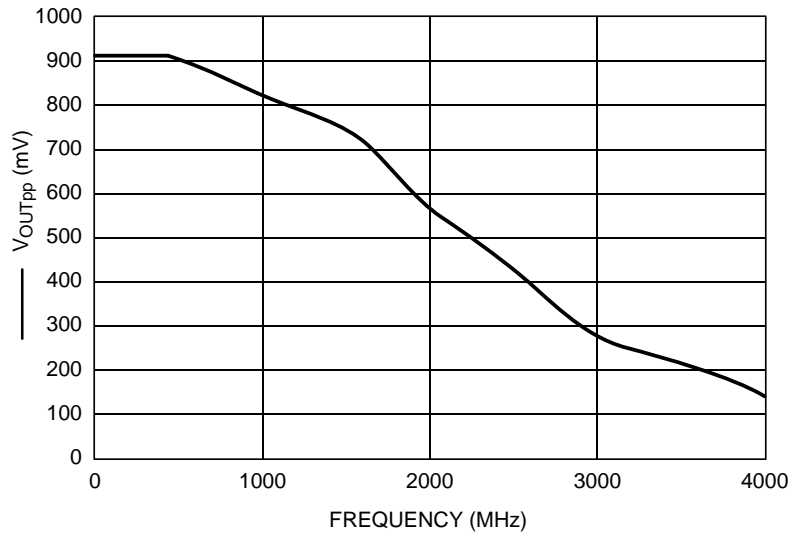
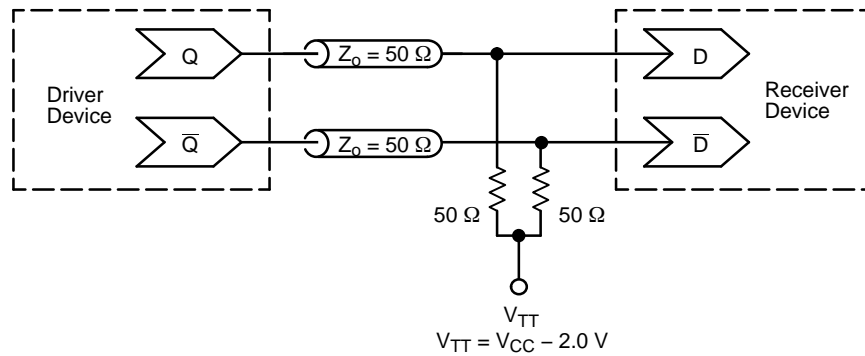

Figure 2. F_{max}

MC10EP57, MC100EP57



**Figure 3. Typical Termination for Output Driver and Device Evaluation
(See Application Note AND8020/D – Termination of ECL Logic Devices.)**

ORDERING INFORMATION

Device	Package	Shipping [†]
MC10EP57DTG	TSSOP-20 (Pb-Free)	75 Units / Rail
MC10EP57DTR2G	TSSOP-20 (Pb-Free)	2500 / Tape & Reel
MC10EP57MNG	QFN-20 (Pb-Free)	92 Units / Rail
MC10EP57MNTXG	QFN-20 (Pb-Free)	3000 / Tape & Reel
MC100EP57DTG	TSSOP-20 (Pb-Free)	75 Units / Rail
MC100EP57DTR2G	TSSOP-20 (Pb-Free)	2500 / Tape & Reel
MC100EP57MNG	QFN-20 (Pb-Free)	92 Units / Rail
MC100EP57MNTXG	QFN-20 (Pb-Free)	3000 / Tape & Reel

[†]For information on tape and reel specifications, including part orientation and tape sizes, please refer to our Tape and Reel Packaging Specifications Brochure, BRD8011/D.

Resource Reference of Application Notes

- AN1405/D** – ECL Clock Distribution Techniques
- AN1406/D** – Designing with PECL (ECL at +5.0 V)
- AN1503/D** – ECLinPS™ I/O SPICE Modeling Kit
- AN1504/D** – Metastability and the ECLinPS Family
- AN1568/D** – Interfacing Between LVDS and ECL
- AN1672/D** – The ECL Translator Guide
- AND8001/D** – Odd Number Counters Design
- AND8002/D** – Marking and Date Codes
- AND8020/D** – Termination of ECL Logic Devices
- AND8066/D** – Interfacing with ECLinPS
- AND8090/D** – AC Characteristics of ECL Devices

MC10EP57, MC100EP57

PACKAGE DIMENSIONS

TSSOP-20
CASE 948E-02
ISSUE C

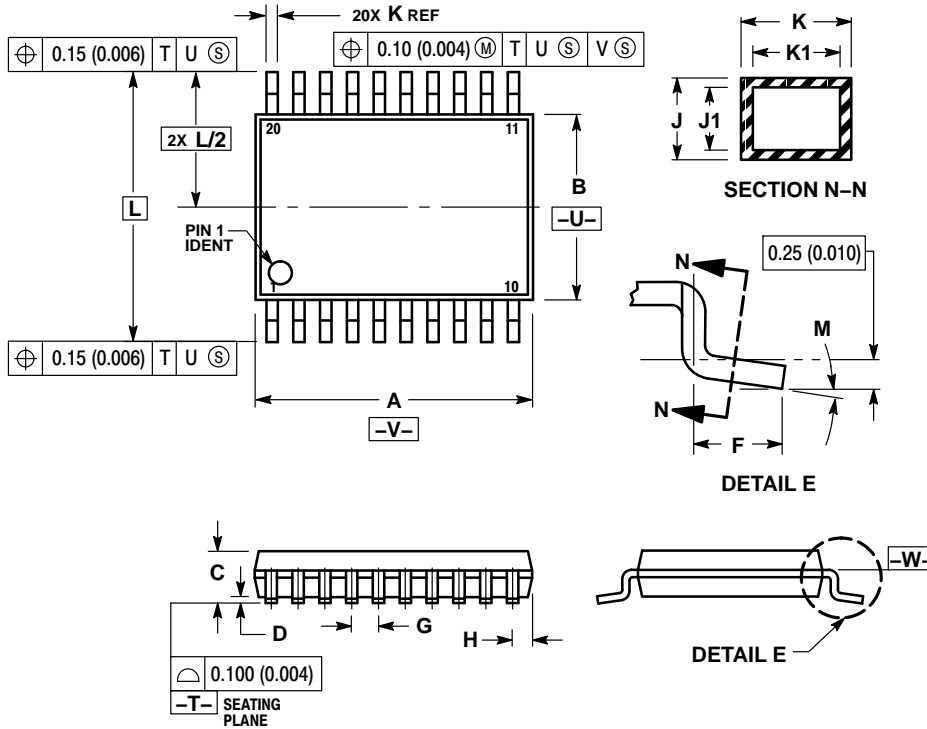

NOTES:

1. DIMENSIONING AND TOLERANCING PER ANSI Y14.5M, 1982.
2. CONTROLLING DIMENSION: MILLIMETER.
3. DIMENSION A DOES NOT INCLUDE MOLD FLASH, PROTRUSIONS OR GATE BURRS. MOLD FLASH OR GATE BURRS SHALL NOT EXCEED 0.15 (0.006) PER SIDE.
4. DIMENSION B DOES NOT INCLUDE INTERLEAD FLASH OR PROTRUSION. INTERLEAD FLASH OR PROTRUSION SHALL NOT EXCEED 0.25 (0.010) PER SIDE.
5. DIMENSION K DOES NOT INCLUDE DAMBAR PROTRUSION. ALLOWABLE DAMBAR PROTRUSION SHALL BE 0.08 (0.003) TOTAL IN EXCESS OF THE K DIMENSION AT MAXIMUM MATERIAL CONDITION.
6. TERMINAL NUMBERS ARE SHOWN FOR REFERENCE ONLY.
7. DIMENSION A AND B ARE TO BE DETERMINED AT DATUM PLANE -W-.

DIM	MILLIMETERS		INCHES	
	MIN	MAX	MIN	MAX
A	6.40	6.60	0.252	0.260
B	4.30	4.50	0.169	0.177
C	---	1.20	---	0.047
D	0.05	0.15	0.002	0.006
F	0.50	0.75	0.020	0.030
G	0.65 BSC		0.026 BSC	
H	0.27	0.37	0.011	0.015
J	0.09	0.20	0.004	0.008
J1	0.09	0.16	0.004	0.006
K	0.19	0.30	0.007	0.012
K1	0.19	0.25	0.007	0.010
L	6.40 BSC		0.252 BSC	
M	0°	8°	0°	8°

SOLDERING FOOTPRINT*

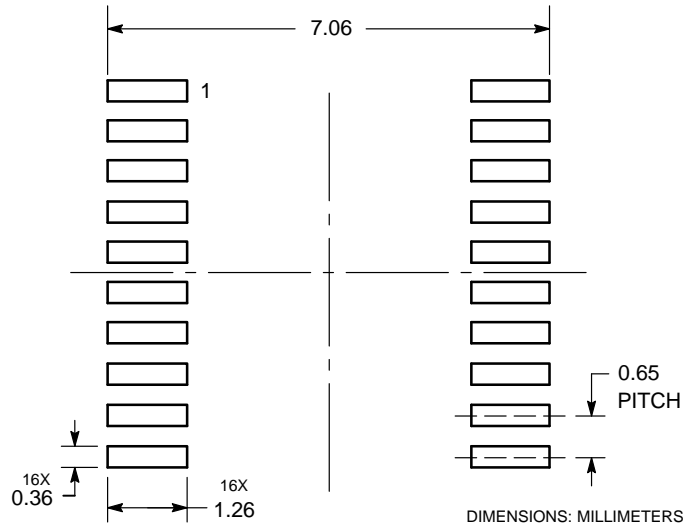

*For additional information on our Pb-Free strategy and soldering details, please download the ON Semiconductor Soldering and Mounting Techniques Reference Manual, SOLDERRM/D.

MC10EP57, MC100EP57

PACKAGE DIMENSIONS

QFN-20, 4x4, 0.5P
CASE 485E
ISSUE B

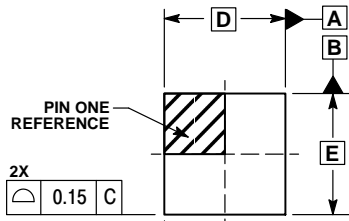

TOP VIEW

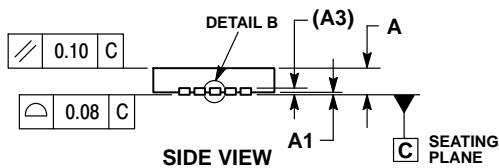

SIDE VIEW

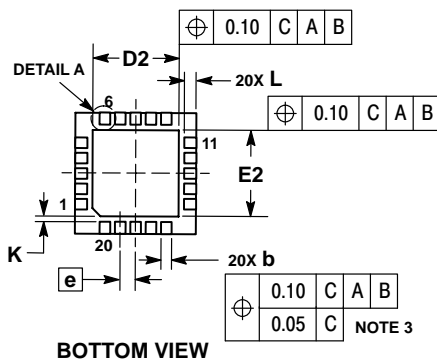

BOTTOM VIEW

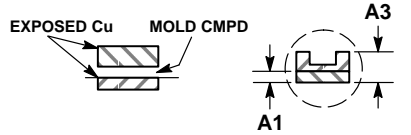

DETAIL B
OPTIONAL CONSTRUCTIONS

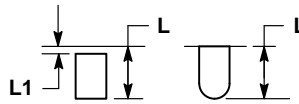

DETAIL A
OPTIONAL CONSTRUCTIONS

NOTES:

1. DIMENSIONING AND TOLERANCING PER ASME Y14.5M, 1994.
2. CONTROLLING DIMENSION: MILLIMETERS.
3. DIMENSION b APPLIES TO PLATED TERMINAL AND IS MEASURED BETWEEN 0.15 AND 0.30 MM FROM THE TERMINAL TIP.
4. COPLANARITY APPLIES TO THE EXPOSED PAD AS WELL AS THE TERMINALS.

DIM	MILLIMETERS	
	MIN	MAX
A	0.80	1.00
A1	---	0.05
A3	0.20 REF	
b	0.20	0.30
D	4.00 BSC	
D2	2.60	2.90
E	4.00 BSC	
E2	2.60	2.90
e	0.50 BSC	
K	0.20 REF	
L	0.35	0.45
L1	0.00	0.15

SOLDERING FOOTPRINT*

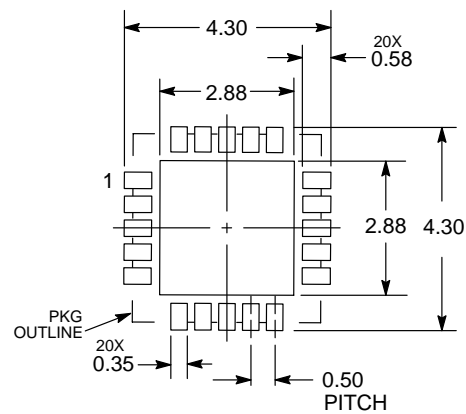

DIMENSIONS: MILLIMETERS

*For additional information on our Pb-Free strategy and soldering details, please download the ON Semiconductor Soldering and Mounting Techniques Reference Manual, SOLDERRM/D.

ECLinPS is a trademark of Semiconductor Components Industries, LLC (SCILLC).

ON Semiconductor and are registered trademarks of Semiconductor Components Industries, LLC (SCILLC). SCILLC owns the rights to a number of patents, trademarks, copyrights, trade secrets, and other intellectual property. A listing of SCILLC's product/patent coverage may be accessed at www.onsemi.com/site/pdf/Patent-Marking.pdf. SCILLC reserves the right to make changes without further notice to any products herein. SCILLC makes no warranty, representation or guarantee regarding the suitability of its products for any particular purpose, nor does SCILLC assume any liability arising out of the application or use of any product or circuit, and specifically disclaims any and all liability, including without limitation special, consequential or incidental damages. "Typical" parameters which may be provided in SCILLC data sheets and/or specifications can and do vary in different applications and actual performance may vary over time. All operating parameters, including "Typicals" must be validated for each customer application by customer's technical experts. SCILLC does not convey any license under its patent rights nor the rights of others. SCILLC products are not designed, intended, or authorized for use as components in systems intended for surgical implant into the body, or other applications intended to support or sustain life, or for any other application in which the failure of the SCILLC product could create a situation where personal injury or death may occur. Should Buyer purchase or use SCILLC products for any such unintended or unauthorized application, Buyer shall indemnify and hold SCILLC and its officers, employees, subsidiaries, affiliates, and distributors harmless against all claims, costs, damages, and expenses, and reasonable attorney fees arising out of, directly or indirectly, any claim of personal injury or death associated with such unintended or unauthorized use, even if such claim alleges that SCILLC was negligent regarding the design or manufacture of the part. SCILLC is an Equal Opportunity/Affirmative Action Employer. This literature is subject to all applicable copyright laws and is not for resale in any manner.

PUBLICATION ORDERING INFORMATION

LITERATURE FULFILLMENT:
Literature Distribution Center for ON Semiconductor
P.O. Box 5163, Denver, Colorado 80217 USA
Phone: 303-675-2175 or 800-344-3860 Toll Free USA/Canada
Fax: 303-675-2176 or 800-344-3867 Toll Free USA/Canada
Email: orderlit@onsemi.com

N. American Technical Support: 800-282-9855 Toll Free
USA/Canada
Europe, Middle East and Africa Technical Support:
Phone: 421 33 790 2910
Japan Customer Focus Center
Phone: 81-3-5817-1050

ON Semiconductor Website: www.onsemi.com
Order Literature: <http://www.onsemi.com/orderlit>
For additional information, please contact your local Sales Representative